

Spice:

Synonymous with function and performance, the new era of high intensity illumination in LED. With its high flux output and high luminous intensity, It transcends today LED lightings technology and how we perceive it.



Features:

- > Super high brightness surface mount LED
- > 120° viewing angle.
- > Compact package outline (LxW) of 3.0 x 1.4 mm.
- > Ultra low height profile - 0.52mm.
- > Low thermal resistance.
- > Build-in ESD protection device.
- > Environmental friendly; RoHS compliance.
- > Compliance to automotive standard; AEC-Q101.



Applications:

- > Automotive: Back-light applications.

Optical Characteristics at Tj=25°C

Part Ordering Number	Color	Viewing Angle°	Luminous Flux @ 80mA (lm) <small>Appx. 1.2</small>		
			Min.	Typ.	Max.
SEW-BZSG-7P8Q-1	White	120	25.1	30.6	37.3

Electrical Characteristics at Tj=25°C

Part Number	Vf @ If = 80 mA <small>Appx. 3.1</small>		
	Min. (V)	Typ. (V)	Max. (V)
SEW-BZSG	2.7	3.0	3.2

Absolute Maximum Ratings

	Maximum Value	Unit
DC forward current	150	mA
Peak pulse current	200	mA
Reverse voltage	Not for reserve bias	V
ESD threshold (HBM)	2000	V
LED junction temperature	120	°C
Operating temperature	-40 ... +100	°C
Storage temperature	-40 ... +100	°C
Thermal resistance - Junction / solder point, R _{th JS} (Mounted on dual sided FR4 in house PCB, total Cu area >900mm ²)	28	K/W

SEW-BZSG, Color Grouping *Appx. 2.1*

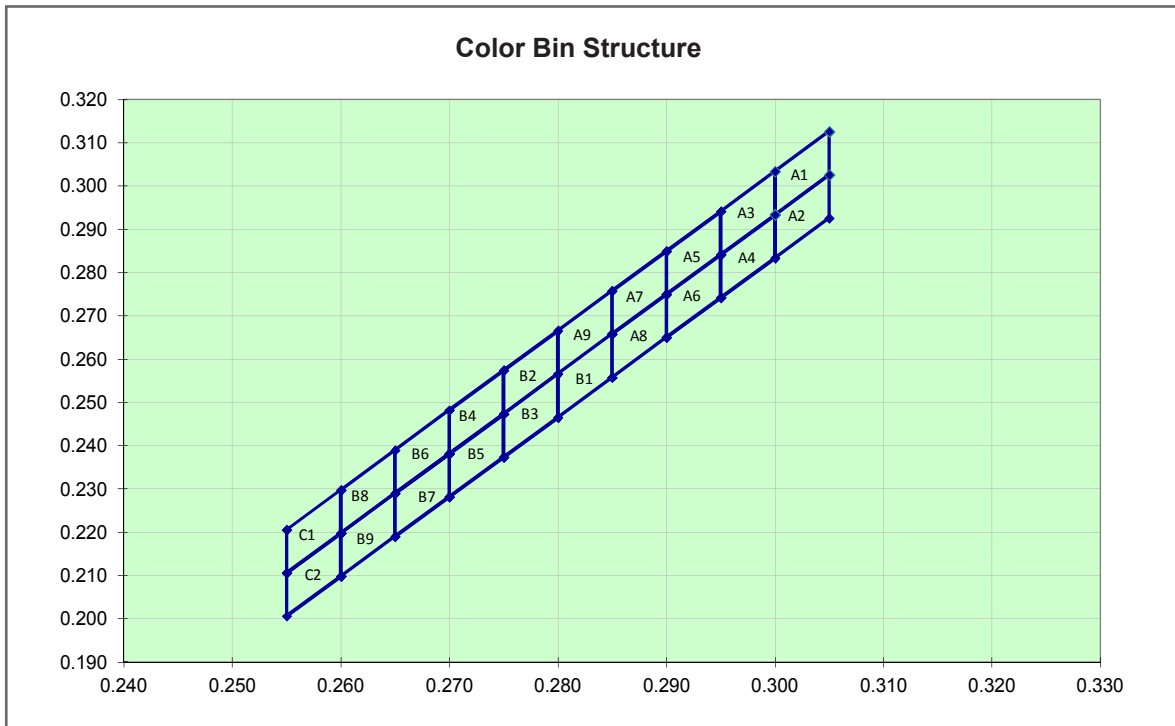

Bin		1	2	3	4
A1	Cx	0.3000	0.3000	0.3050	0.3050
	Cy	0.2934	0.3034	0.3126	0.3026
A3	Cx	0.2950	0.2950	0.3000	0.3000
	Cy	0.2842	0.2942	0.3034	0.2934
A5	Cx	0.2900	0.2900	0.2950	0.2950
	Cy	0.2750	0.2850	0.2942	0.2842
A7	Cx	0.2850	0.2850	0.2900	0.2900
	Cy	0.2658	0.2758	0.2850	0.2750
A9	Cx	0.2800	0.2800	0.2850	0.2850
	Cy	0.2566	0.2666	0.2758	0.2658
B2	Cx	0.2750	0.2750	0.2800	0.2800
	Cy	0.2474	0.2574	0.2666	0.2566
B4	Cx	0.2700	0.2700	0.2750	0.2750
	Cy	0.2382	0.2482	0.2574	0.2474
B6	Cx	0.2650	0.2650	0.2700	0.2700
	Cy	0.2290	0.2390	0.2482	0.2382
B8	Cx	0.2600	0.2600	0.2650	0.2650
	Cy	0.2198	0.2298	0.2390	0.2290

Bin		1	2	3	4
A2	Cx	0.3000	0.3000	0.3050	0.3050
	Cy	0.2834	0.2934	0.3026	0.2926
A4	Cx	0.2950	0.2950	0.3000	0.3000
	Cy	0.2742	0.2842	0.2934	0.2834
A6	Cx	0.2900	0.2900	0.2950	0.2950
	Cy	0.2650	0.2750	0.2842	0.2742
A8	Cx	0.2850	0.2850	0.2900	0.2900
	Cy	0.2558	0.2658	0.2750	0.2650
B1	Cx	0.2800	0.2800	0.2850	0.2850
	Cy	0.2466	0.2566	0.2658	0.2558
B3	Cx	0.2750	0.2750	0.2800	0.2800
	Cy	0.2374	0.2474	0.2566	0.2466
B5	Cx	0.2700	0.2700	0.2750	0.2750
	Cy	0.2282	0.2382	0.2474	0.2374
B7	Cx	0.2650	0.2650	0.2700	0.2700
	Cy	0.2190	0.2290	0.2382	0.2282
B9	Cx	0.2600	0.2600	0.2650	0.2650
	Cy	0.2098	0.2198	0.2290	0.2190
C1	Cx	0.2550	0.2600	0.2600	0.2550
	Cy	0.2206	0.2298	0.2198	0.2106
C2	Cx	0.2550	0.2600	0.2600	0.2550
	Cy	0.2106	0.2198	0.2098	0.2006

Luminous Intensity Group

Brightness Group	Luminous Flux <small>Appx. 1.2</small> (lm)
7P	25.1 ... 26.8
8P	26.8 ... 28.7
9P	28.7 ... 30.6
6Q	30.6 ... 32.7
7Q	32.7 ... 34.8
8Q	34.8 ... 37.3

Vf Binning

Vf Bin @ 80mA	Forward Voltage (V) <small>Appx. 3.1</small>
V1	2.70 ... 2.80
V2	2.80 ... 2.90
V3	2.90 ... 3.00
V4	3.00 ... 3.10
V5	3.10 ... 3.20

Relative Luminous Flux Vs Forward Current

$\Phi_v/\Phi_v(80\text{mA}) = f(I_F); T_j = 25^\circ\text{C}$

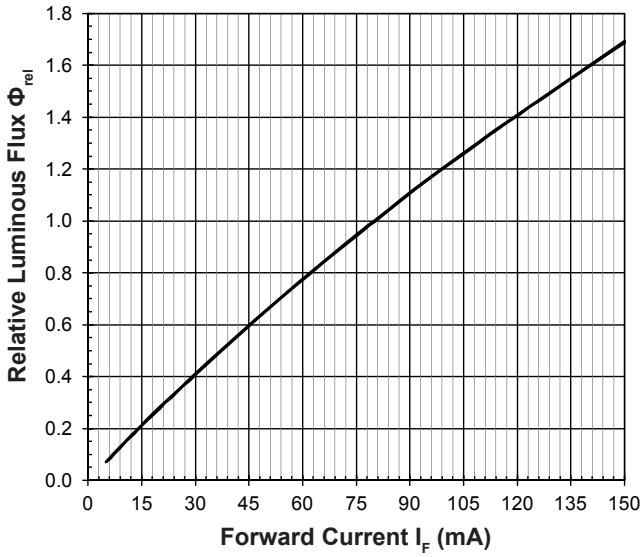

Forward Current Vs Forward Voltage

$I_F = f(V_F); T_j = 25^\circ\text{C}$

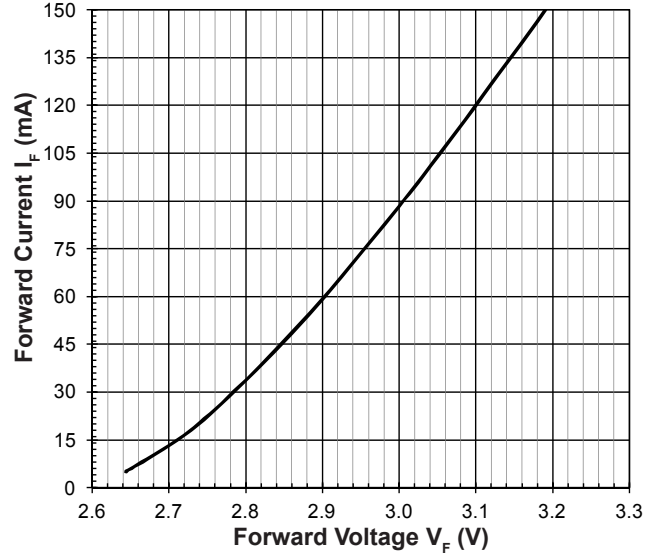

Maximum Current Vs Temperature

$I_F = f(T)$

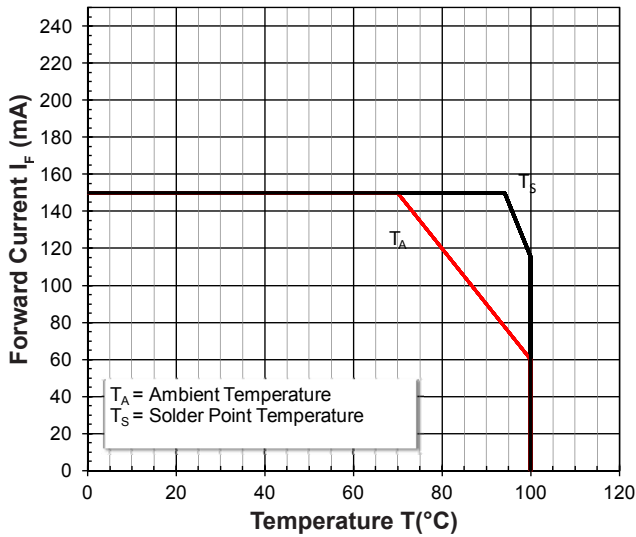

Relative Spectral Emission

$\Phi_{rel} = f(\lambda); T_j = 25^\circ\text{C}; I_c = 80\text{mA}$

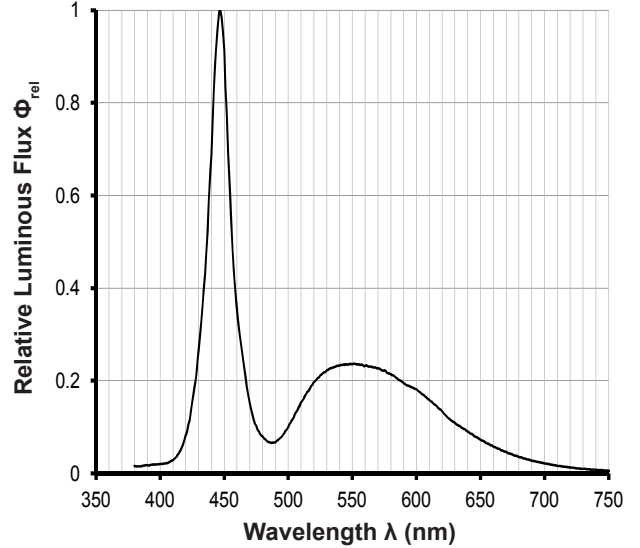

Chromaticity Coordinate Shift Vs Forward Current

$\Delta Cx, \Delta Cy = f(I_F); T_j = 25^\circ\text{C}$

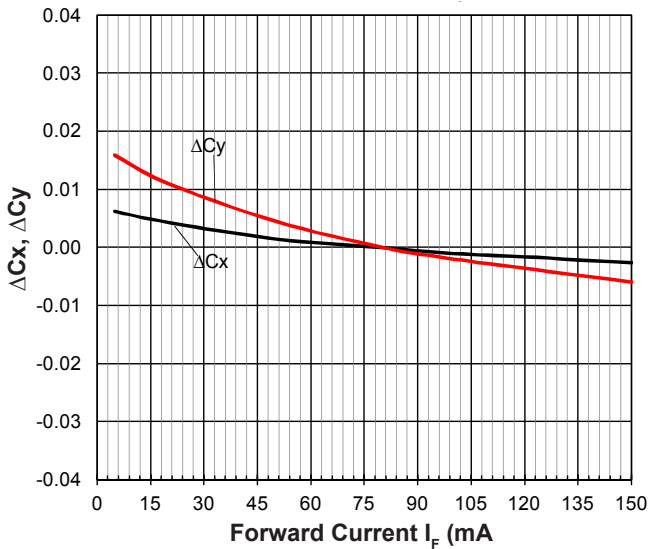

Allowable Forward Current Vs Duty Ratio

$(T_j = 25^\circ\text{C}; t_p \leq 10\mu\text{s})$

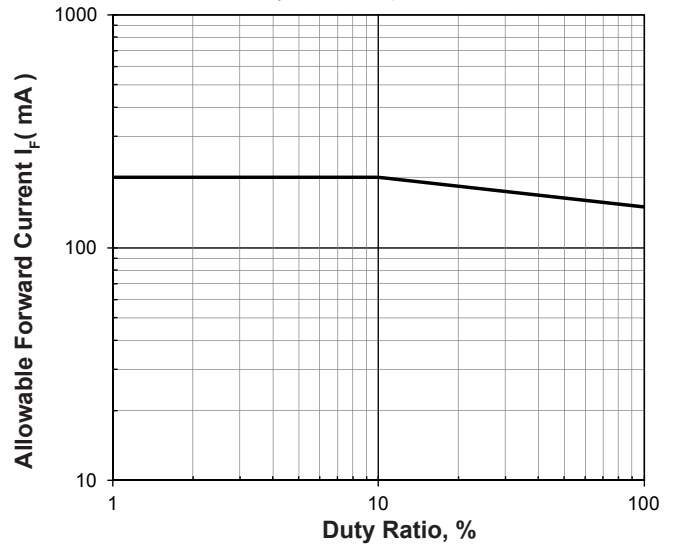

Radiation Pattern

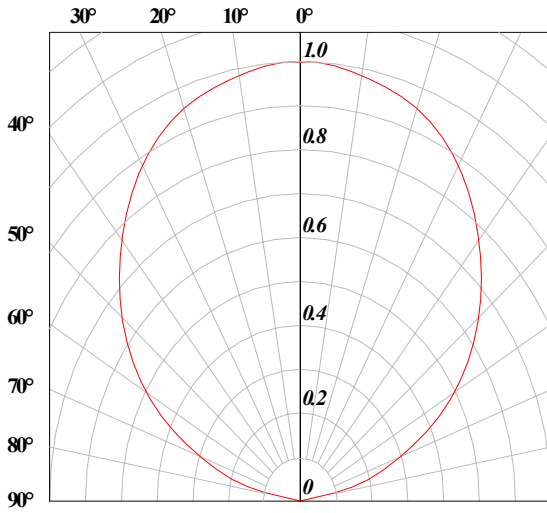

Relative Forward Voltage Vs Junction Temperature

$\Delta V_F = V_F - V_F(25^\circ\text{C}) = f(T_j); I_F = 80\text{mA}$

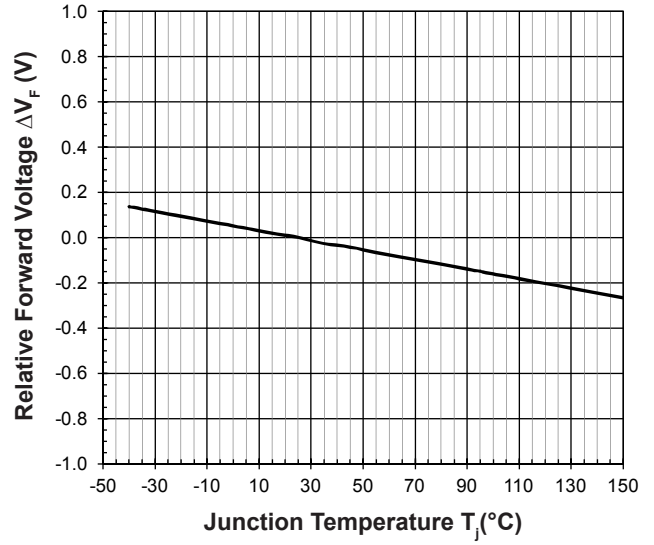

Relative Luminous Flux Vs Junction Temperature

$\Phi_V/\Phi_V(25^\circ\text{C}) = f(T_j); I_F = 80\text{mA}$

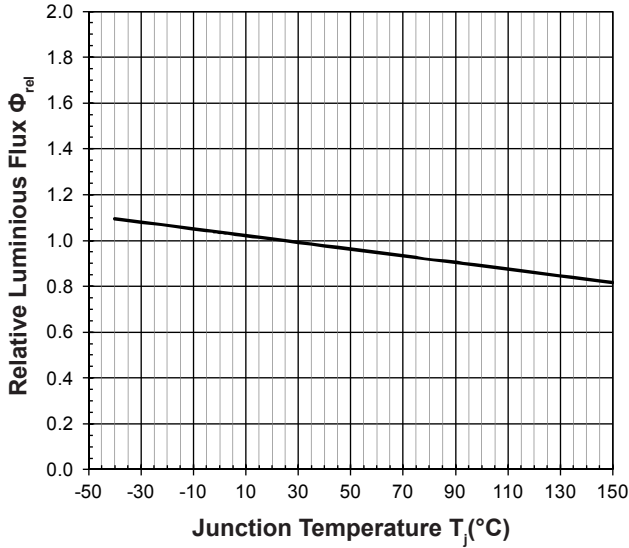

Chromaticity Coordinate Shift Vs Junction Temperature

$\Delta C_x, \Delta C_y = f(T_j); I_F = 80\text{mA}$

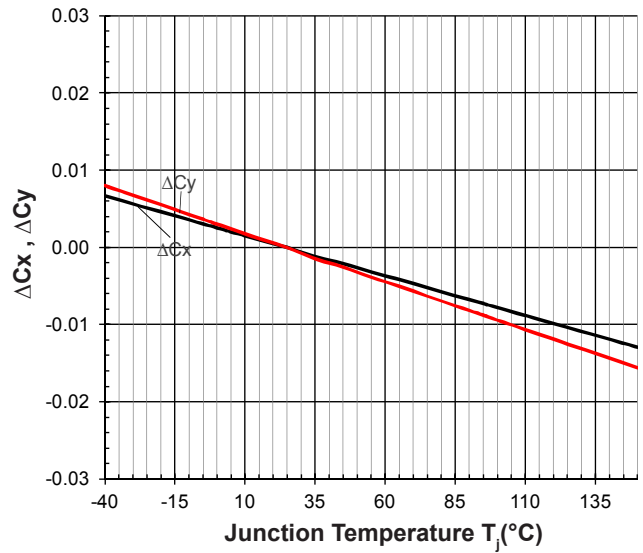

SpicePlus 3014 • 80 InGaN White: SEW-BZSG Package Outlines

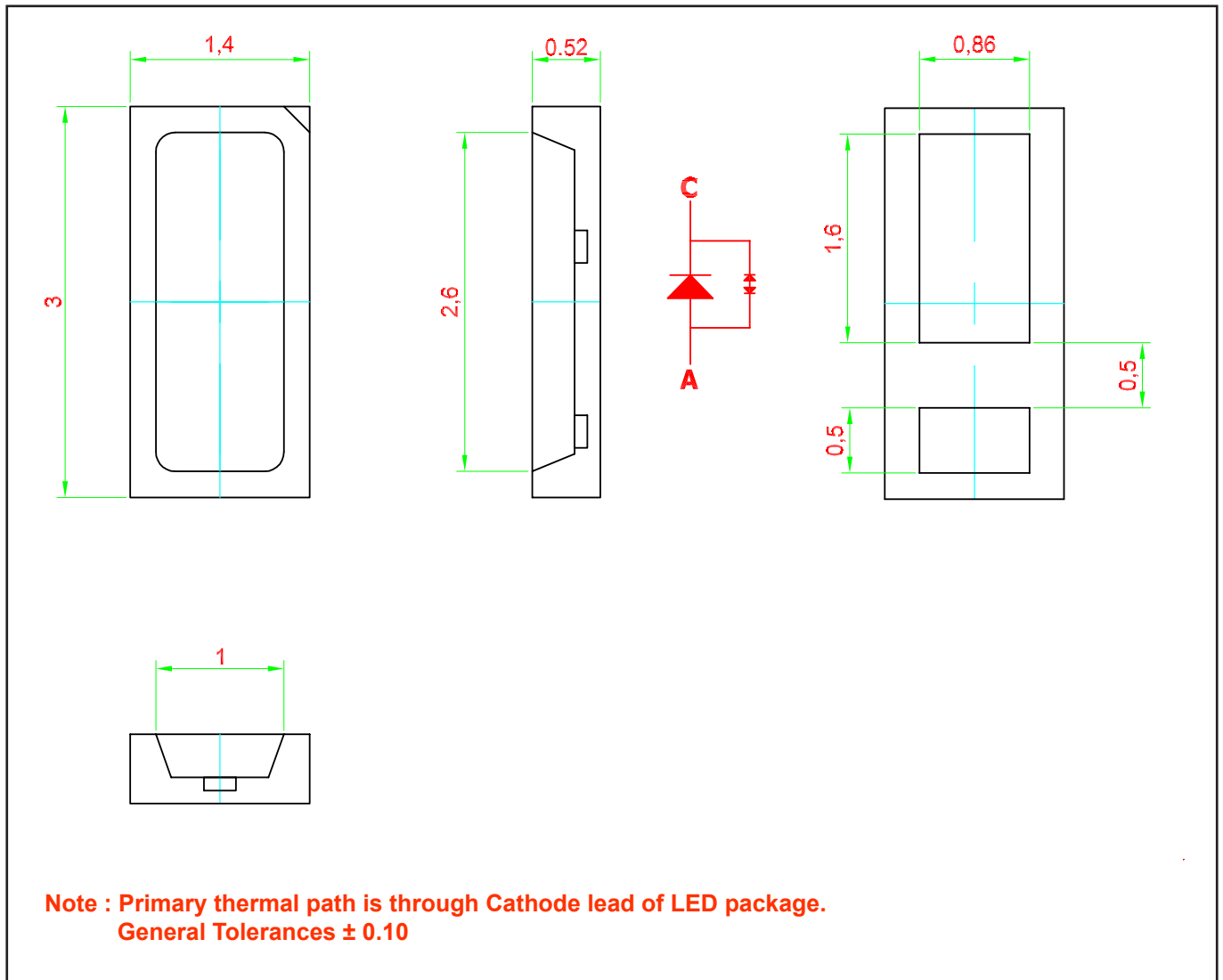

Material

	Material
Lead-frame	Cu Alloy With Ag Plating
Package	Heat Resistant Polymer
Encapsulant	Silicone Resin
Soldering Leads	Ag Plating

Recommended Solder Pad

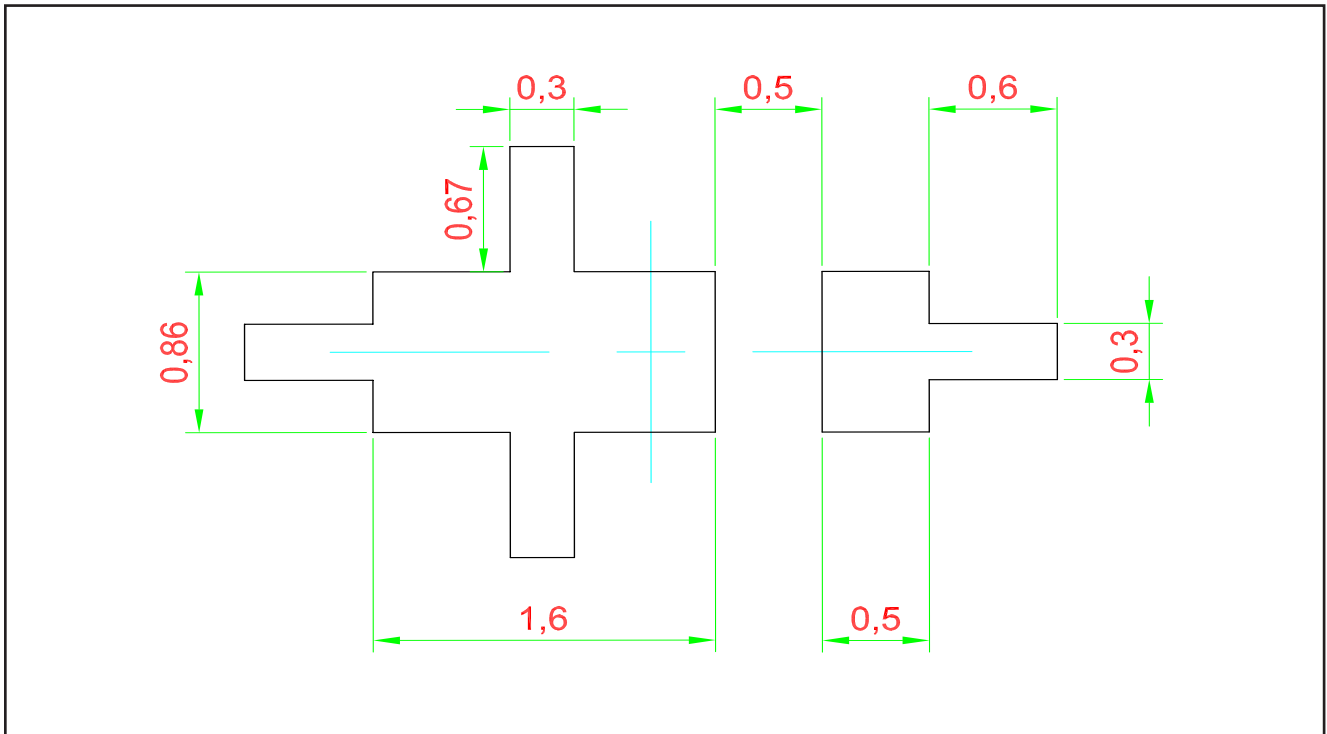

Packaging Specification

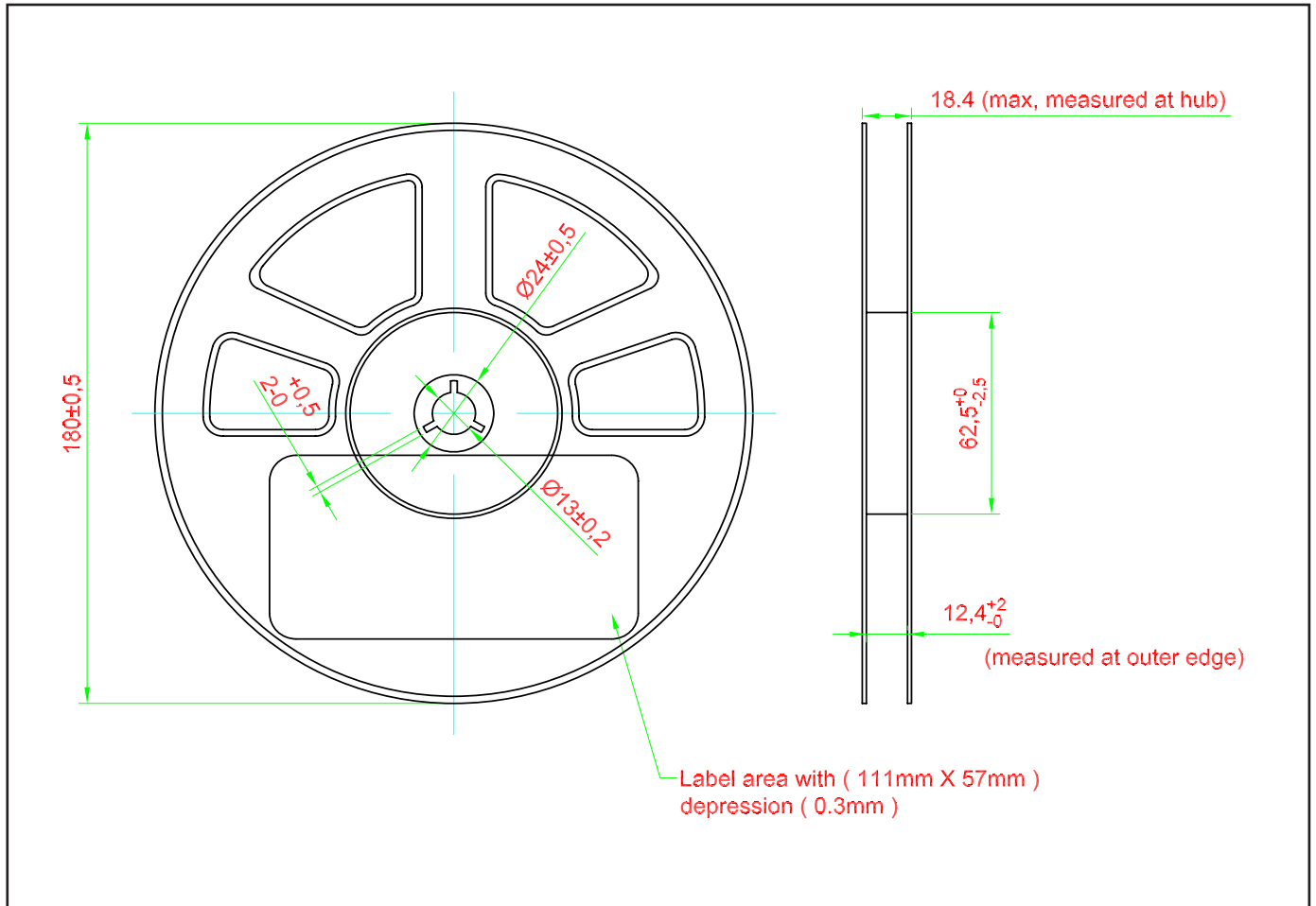

Packaging Specification

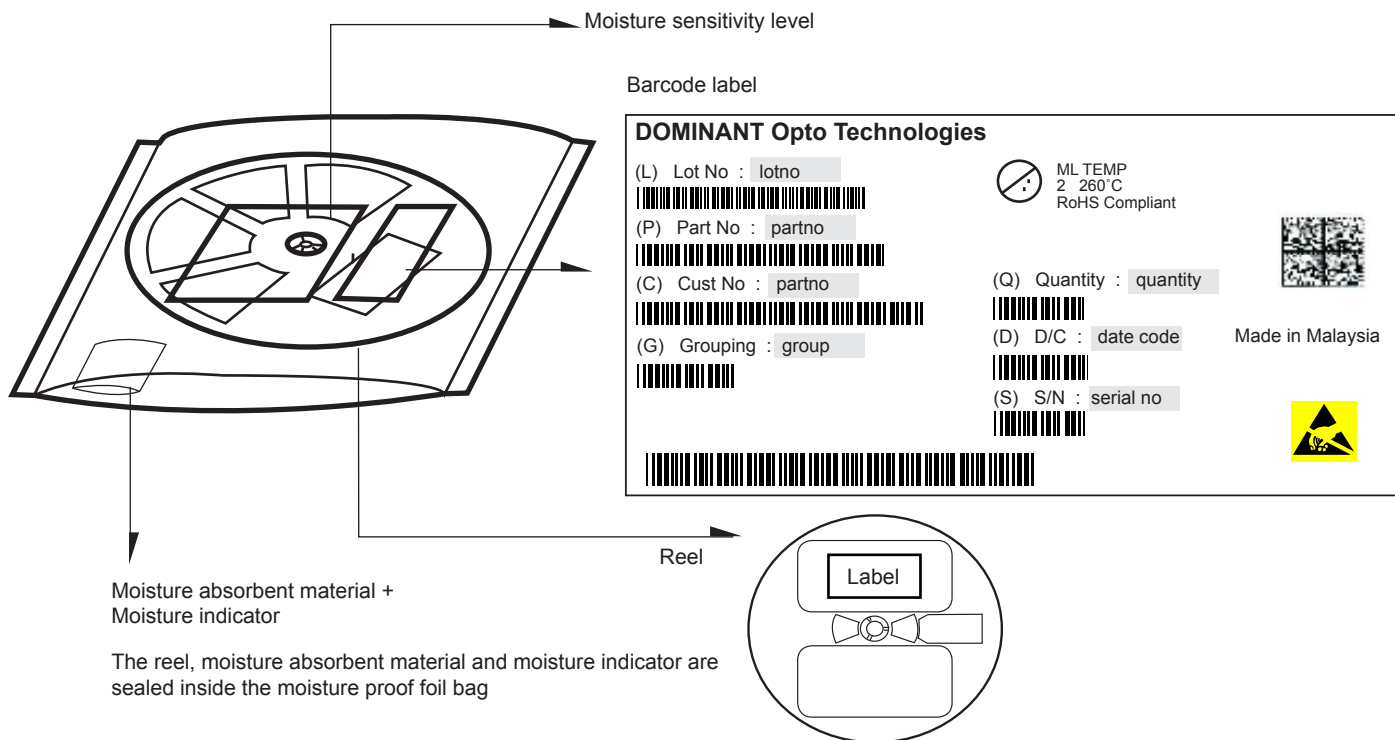

	Average 1pc SpicePlus 3014	1 completed bag (3000pcs)
Weight (gram)	0.011	200 ± 10

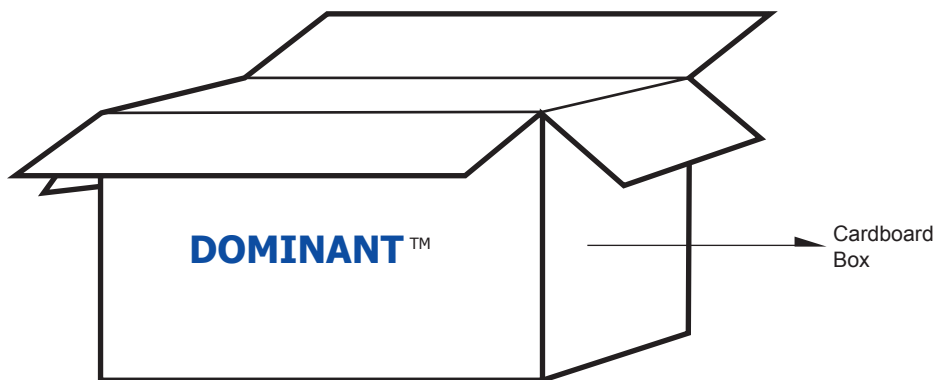

For SpicePlus 3014

Cardboard Box Size	Dimensions (mm)	Empty Box Weight (kg)	Reel / Box
Super Small	325 x 225 x 190	0.38	9 reels MAX
Small	325 x 225 x 280	0.54	15 reels MAX
Medium	570 x 440 x 230	1.46	60 reels MAX
Large	570 x 440 x 460	1.92	120 reels MAX

Recommended Pb-free Soldering Profile

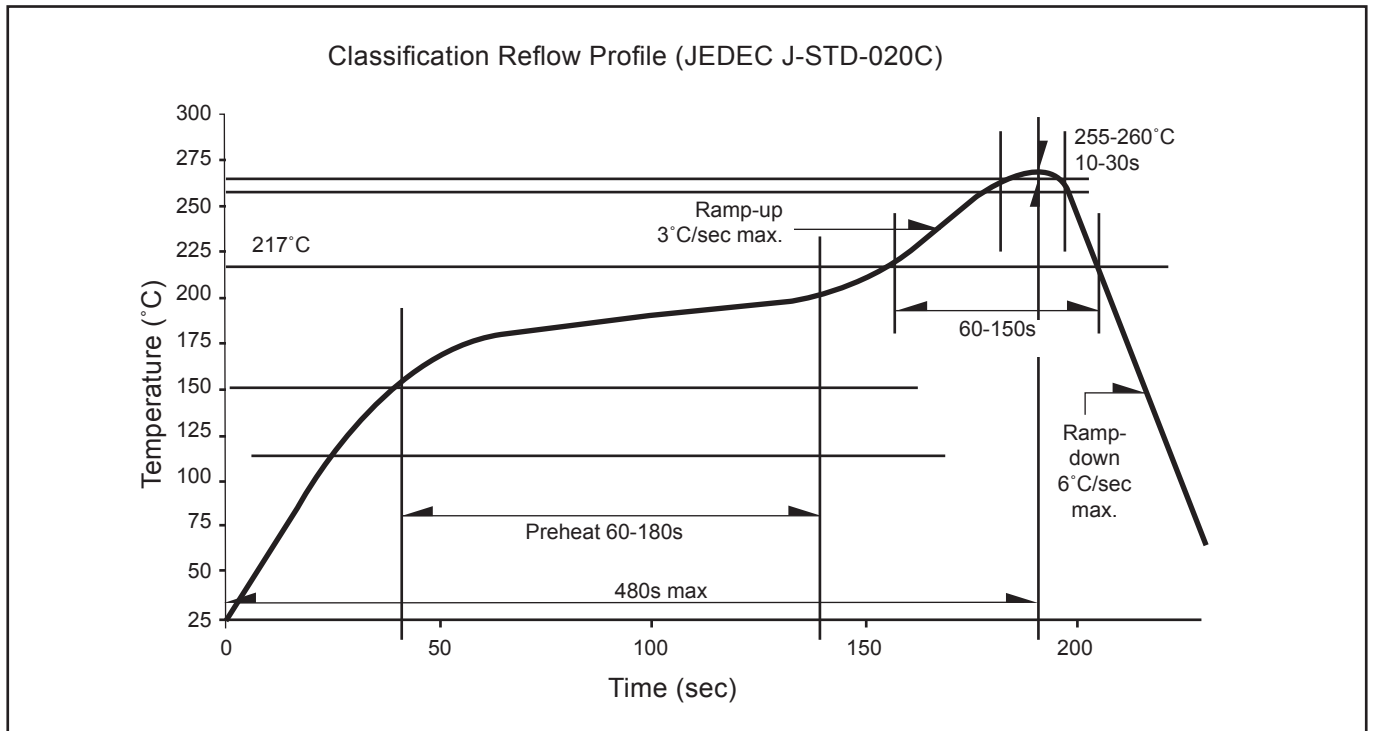

Revision History

Page	Subjects	Date of Modification
-	Initial Release	08 Aug 2016
1, 8	Typo Error on Features Typo Error on Package Outline	26 May 2017
3, 4	Update Color Bin Structure	20 Sep 2017
1	Update Features	20 Dec 2017

NOTE

All the information contained in this document is considered to be reliable at the time of publishing. However, DOMINANT Opto Technologies does not assume any liability arising out of the application or use of any product described herein.

DOMINANT Opto Technologies reserves the right to make changes to any products in order to improve reliability, function or design.

DOMINANT Opto Technologies products are not authorized for use as critical components in life support devices or systems without the express written approval from the Managing Director of DOMINANT Opto Technologies.

Appendix

1) **Brightness:**

- 1.1 Luminous intensity is measured with an internal reproducibility of $\pm 8\%$ and an expanded uncertainty of $\pm 11\%$ (according to GUM with a coverage factor of $k=3$).
- 1.2 Luminous flux is measured with an internal reproducibility of $\pm 8\%$ and an expanded uncertainty of $\pm 11\%$ (according to GUM with a coverage factor of $k=3$).

2) **Color:**

- 2.1 Chromaticity coordinate groups are measured with an internal reproducibility of ± 0.005 and an expanded uncertainty of ± 0.01 (accordingly to GUM with a coverage factor of $k=3$).
- 2.2 DOMINANT wavelength is measured with an internal reproducibility of $\pm 0.5\text{nm}$ and an expanded uncertainty of $\pm 1\text{nm}$ (accordingly to GUM with a coverage factor of $k=3$).

3) **Voltage:**

- 3.1 Forward Voltage, V_f is measured with an internal reproducibility of $\pm 0.05\text{V}$ and an expanded uncertainty of $\pm 0.1\text{V}$ (accordingly to GUM with a coverage factor of $k=3$).

About Us

DOMINANT Opto Technologies is a dynamic company that is amongst the world's leading automotive LED manufacturers. With an extensive industry experience and relentless pursuit of innovation, DOMINANT's state-of-art manufacturing and development capabilities have become a trusted and reliable brand across the globe. More information about DOMINANT Opto Technologies, a ISO/TS 16949 and ISO 14001 certified company, can be found under <http://www.dominant-semi.com>.

Please contact us for more information:

DOMINANT Opto Technologies Sdn. Bhd
Lot 6, Batu Berendam, FTZ Phase III, 75350 Melaka, Malaysia.
Tel: +606 283 3566 Fax: +606 283 0566
E-mail: sales@dominant-semi.com
