

Features:

- ✓ Small size, minimal footprint – SMT/SIP package
- ✓ 5A Output Current (all voltages)
- ✓ High Efficiency: up to 94%
- ✓ High reliability
- ✓ RoHS Compliant
- ✓ Cost efficient open frame design
- ✓ Output voltage programmable by an external resistor.
- ✓ Monotonic Start with Pre-Bias.

Output				Input			Efficiency		
Vout (V)	Iout (A)	PARD (mVp-p)		Regulation Max		Vin Nom. (V)	Range (V)	Iin Typ (A)	Full Load Typ.
		Typ.	Max.	Line	Load				
0.75	5	30	50	+/-0.4%	+/-0.5%	5	3.0– 5.5	0.949	79%
1.2	5	30	50	+/-0.4%	+/-0.5%	5	3.0– 5.5	1.412	85%
1.5	5	30	50	+/-0.4%	+/-0.5%	5	3.0– 5.5	1.724	87%
1.8	5	30	50	+/-0.4%	+/-0.5%	5	3.0– 5.5	2.022	89%
2.0	5	30	50	+/-0.4%	+/-0.5%	5	3.0– 5.5	2.222	90%
2.5	5	30	50	+/-0.4%	+/-0.5%	5	3.0– 5.5	2.217	92%





Input Characteristics	Notes & Conditions	Min	Typ.	Max	Units
Input Voltage Operating Range		3.0	5	5.5	Vdc
Input Reflected Ripple Current			150		mA p-p
Inrush Current Transient				0.2	A ² s
Input Filter Type (external)			100		μF
Input Turn ON Threshold			2.05		V
Input Turn OFF Threshold			1.91		V
Enable (Positive enable has 20K pullup) (Negative enable has no internal pullup resistor)	Positive enable: ON		open		
	Positive enable: OFF		<0.4		Vdc
	Negative enable: ON; open circuit or		<0.4		Vdc
	Negative enable: OFF	2		Vin	

Output Characteristics	Notes & Conditions	Min	Typ.	Max	Units
Vout Accuracy	100% load	-1.5		+1.5	%
Output Loading		0		5	A
Output Ripple & Noise @ 20Mhz Bandwidth.				50	mV
Maximum Capacitive Load	Low ESR			3000	μF
Vout Trim Range (Nom)		0.75		3.63	V
Total Accuracy	Over line/load temperature		<2%		
Current Limit			10		A
Output Line Regulation		-0.4		+0.4	%
Output Load Regulation		-0.5		+0.5	%
Turn-on Overshoot				1	%
SC Protection Technique	Hiccup with auto recovery				
Pre-bias Start-up at output	Unit starts monotonically with pre-bias				

Dynamic Characteristics	Notes & Conditions	Min	Typ.	Max	Units
Load Transient	50% step, 0.1A/μs			200	mV
	Settling Time			200	μs
Frequency			300		KHz
Rise Time	10% Vo to 90% Vo		4.5		ms
Start-Up Time	Vin to Vout and On/Off to Vout Vout rise to monotonic		6.5		ms

General Specifications	Notes & Conditions	Min	Typ.	Max	Units
MTBF	Calculated (MIL-HDBK-217F)		1.5		x10 ⁶ Hrs
Thermal Protection	Thermal Measurement Location (TML)		110		°C
Operating Temperature	Without derating, 0LFM	-40		70	°C
Operating Ambient Temperature	See Power derating curve	-40		85	°C
SIP Dimensions	0.9"Lx0.4"Wx0.22"H (22.9x10.16x5.6mm)				
SMT Dimensions	0.80"Lx0.450"Wx0.24"H (20.3x11.43x6.09mm)				
SIP Pin Dimensions	0.025" (0.64mm) SQUARE		0.64		mm
SMT Block Dimensions	0.090" x 0.062" x 0.062" SQUARE				
Pin and Block Material	Square copper with tin-lead plated				
Weight			2.3		g
Flammability Rating	UL94V-0				

Standards Compliance
CSA C22.2, No.60950/UL 60950, Third Edition (2000)

Thermal Considerations

The power module operates in a variety of thermal environments; however, sufficient cooling should be provided to help ensure reliable operation of the unit.

The thermal data presented is based on measurements taken at various airflows. Note that airflow is parallel to the long axis of the module as shown in Figure 1 and derating applies accordingly.

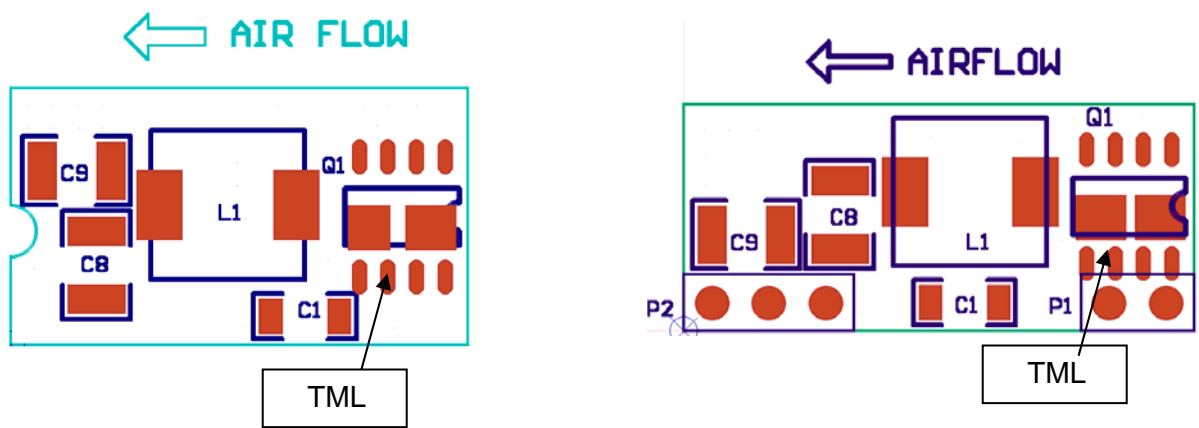

Figure 1. Thermal Tests Set-Up.

The temperature at either TML location should not exceed 110°C. The output power of the module should not exceed the rated power for the module ($V_{o,set} \times I_{o,max}$).

Convection Requirements for Cooling

To predict the approximate cooling needed for the module, refer to the Power Derating Curves in Figures 2-17 .

These derating curve are approximations of the ambient temperature and airflow required to keep the power module temperature below it's maximum rating. Once the module is assembled in the actual system, the module's temperature should be verified.

TYPICAL DERATING CURVES SIP/SMT VERSION

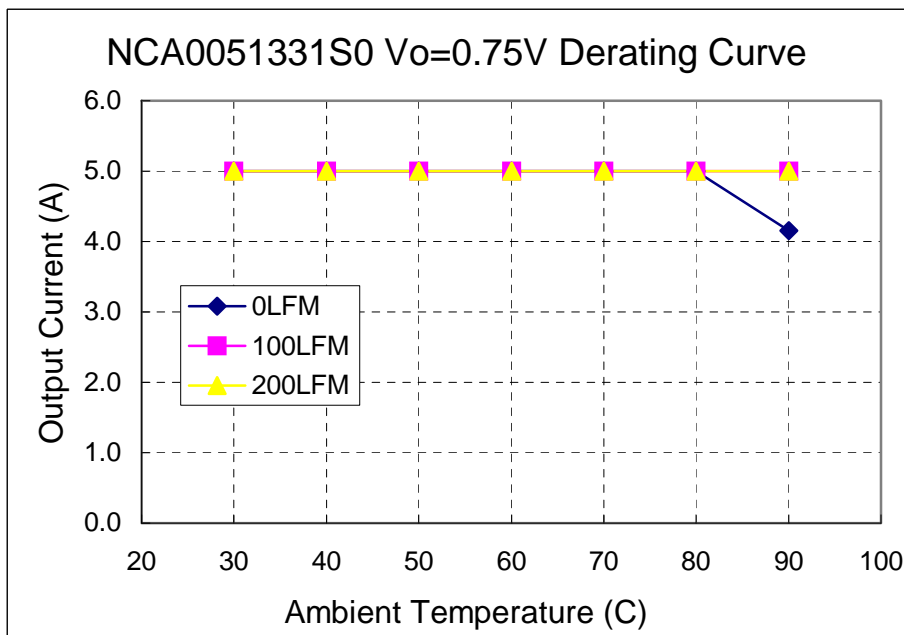

Fig. 2. SMT Power Derating vs Output Current for 5.0Vin 0.75V Out.

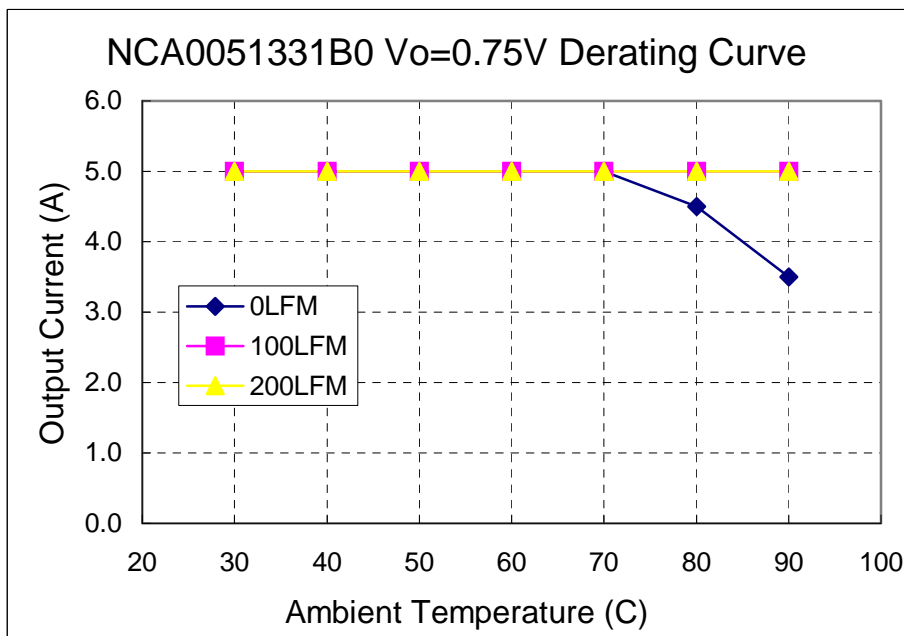

Fig. 3. SIP Power Derating vs Output Current for 5Vin 0.75V Out.

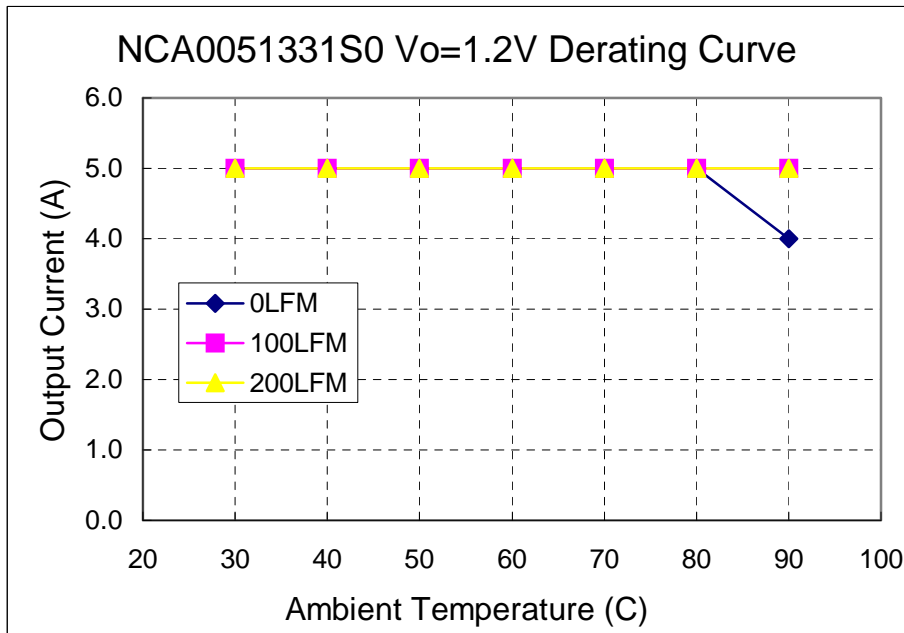

Fig 4. SMT Power Derating vs Output Current for 5.0Vin 1.2V Out.

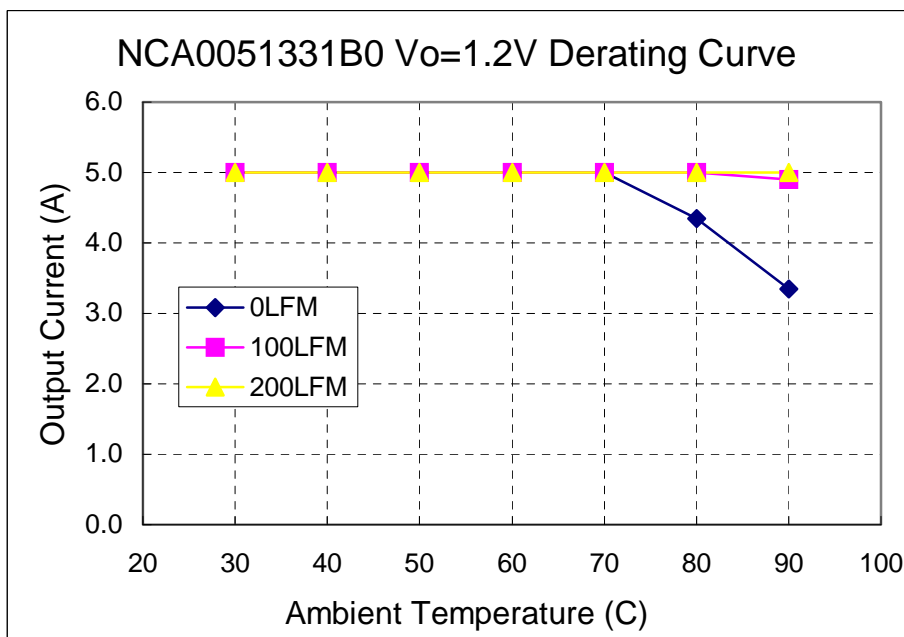

Fig 5. SIP Power Derating vs Output Current for 5.0Vin 1.2V Out.

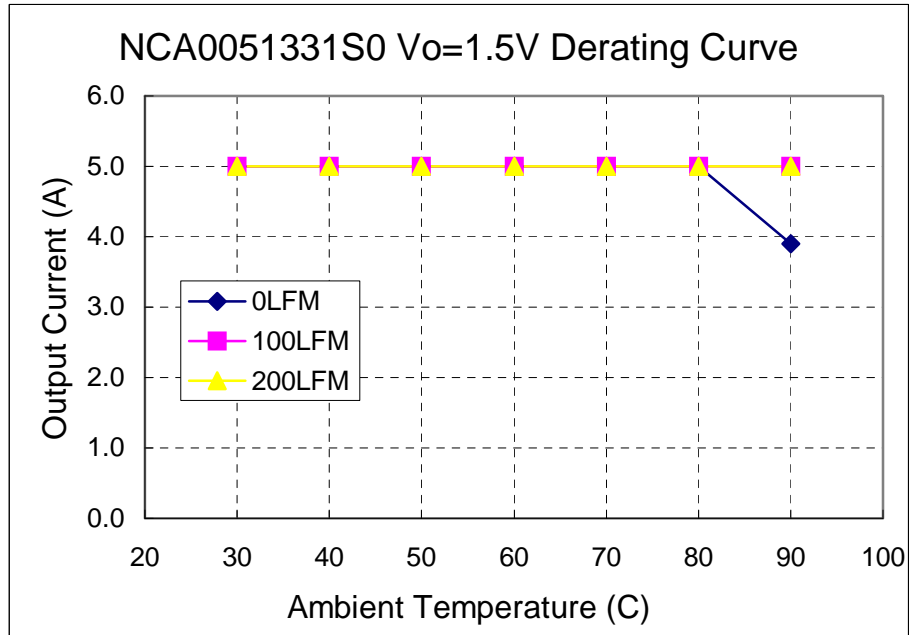

Fig 6. SMT Power Derating vs Output Current for 5.0Vin 1.5V Out.

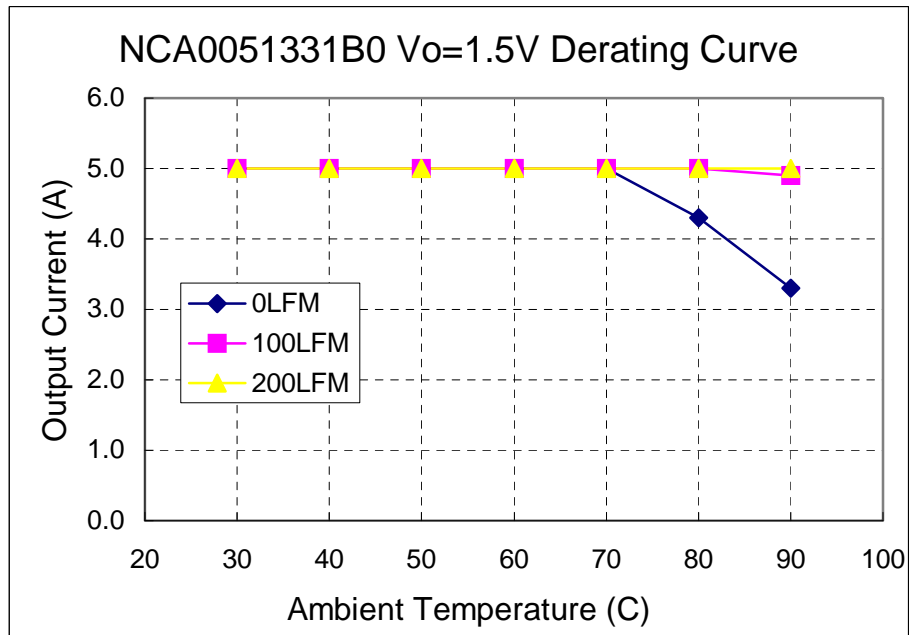

Fig 7. SIP Power Derating vs Output Current for 5.0Vin 1.5V Out.

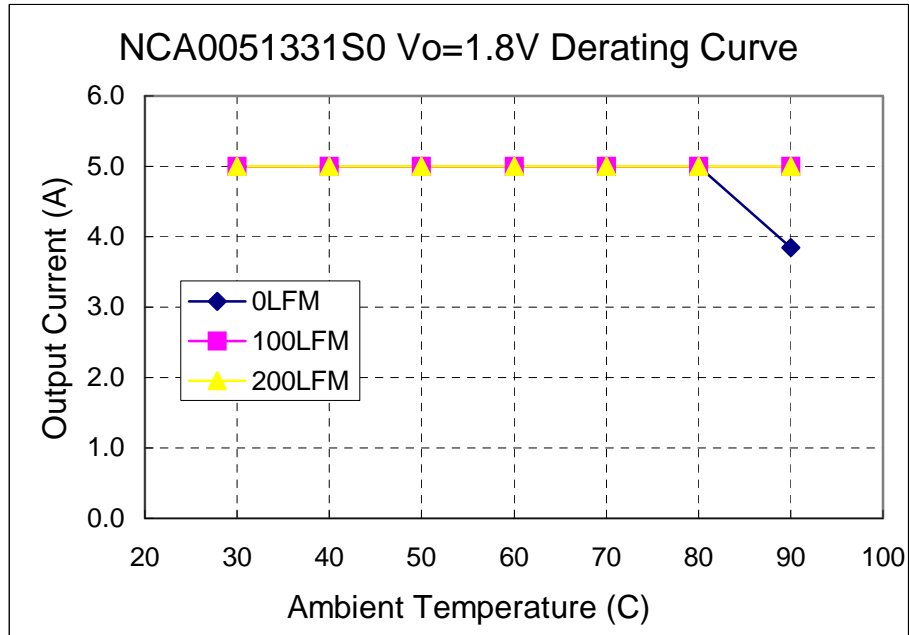

Fig 8. SMT Power Derating vs Output Current for 5.0V_{in} 1.8V Out.

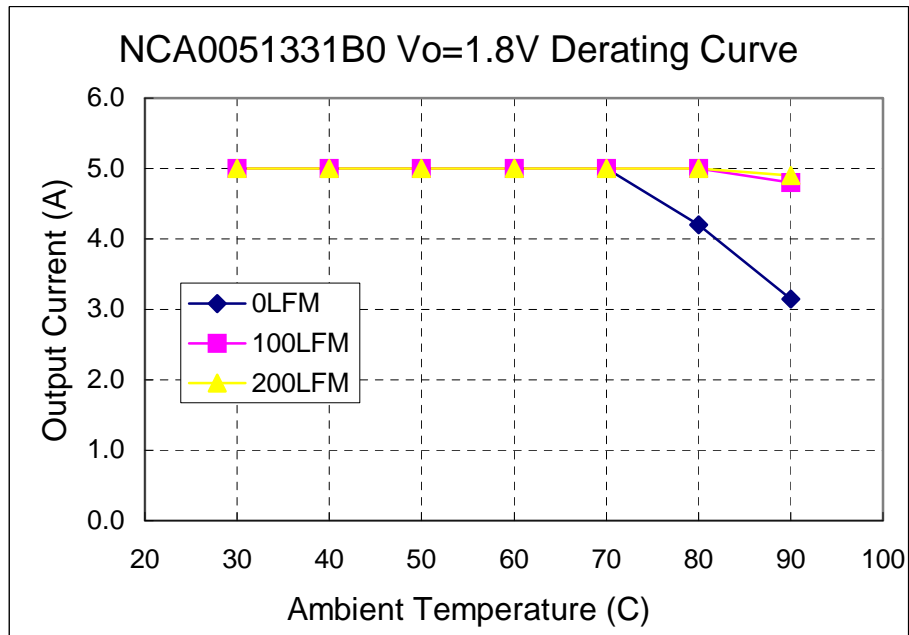

Fig 9. SIP Power Derating vs Output Current for 5.0V_{in} 1.8V Out.

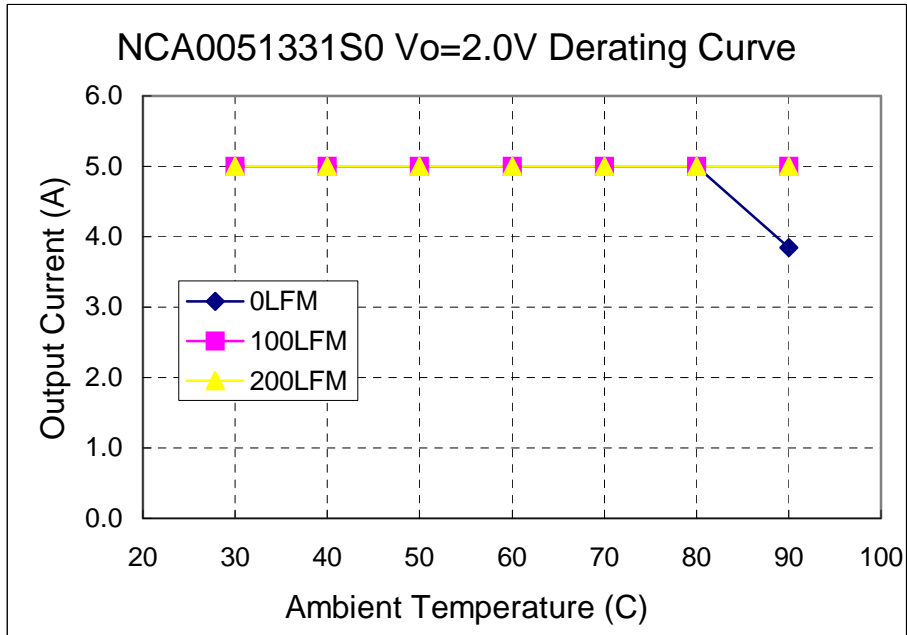

Fig 10. SMT Power Derating vs Output Current for 5.0Vin 2.0V Out.

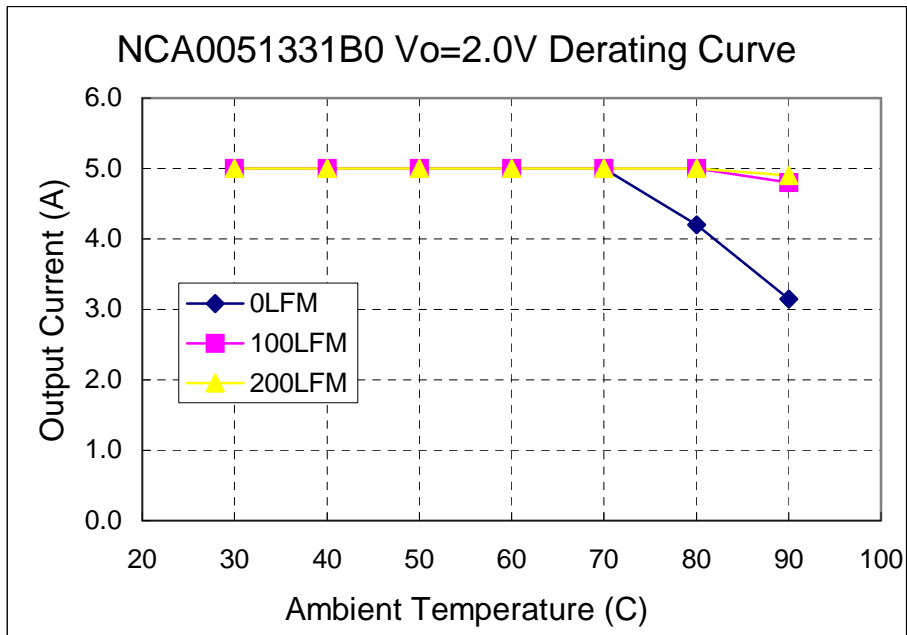

Fig 11. SIP Power Derating vs Output Current for 5.0Vin 2.0V Out.

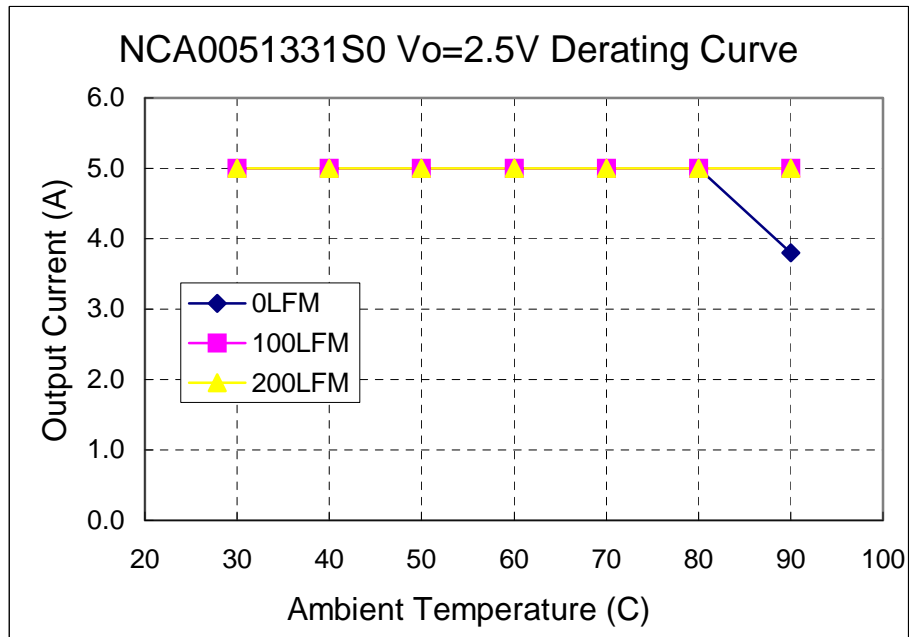

Fig 12. SMT Power Derating vs Output Current for 5.0Vin 2.5V Out.

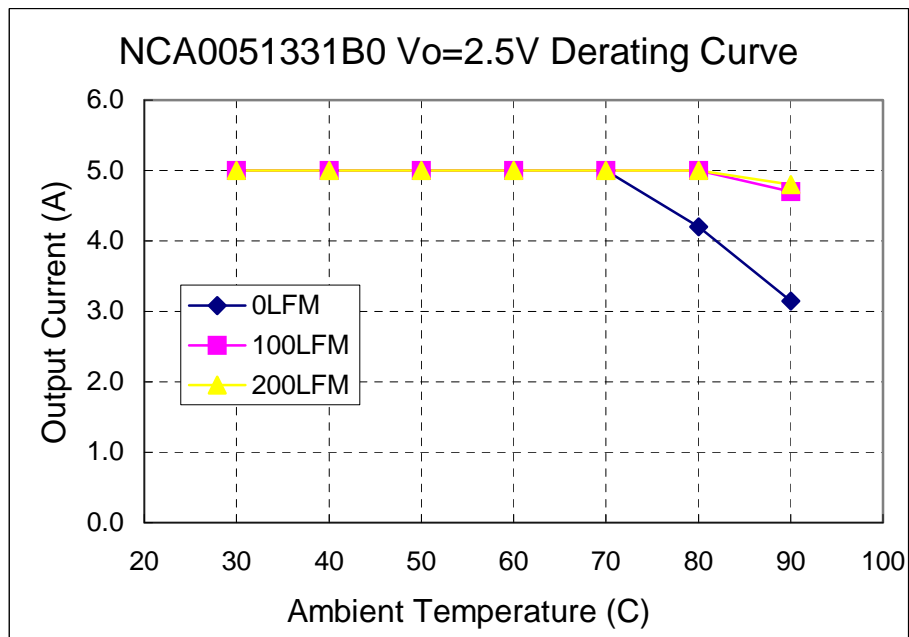

Fig 13. SIP Power Derating vs Output Current for 5.0Vin 2.5V Out.

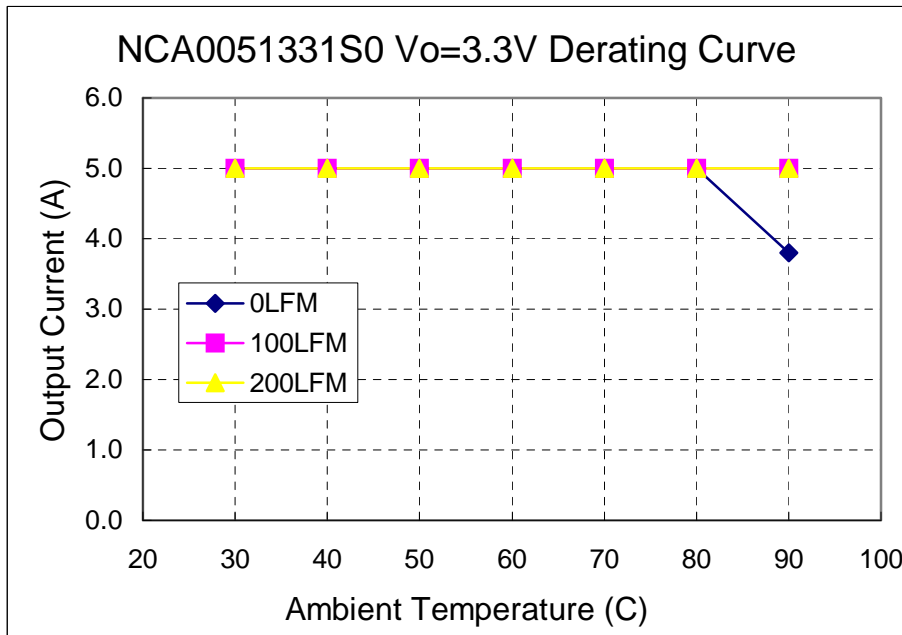

Fig. 14. SMT Power Derating vs Output Current for 5.0Vin 3.3V Out.

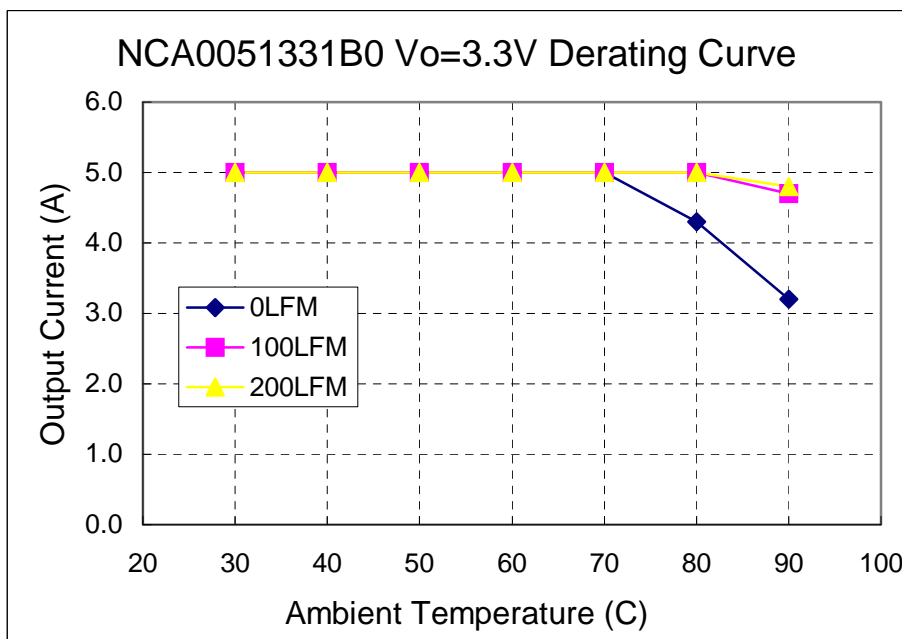

Fig 15. SIP Power Derating vs Output Current for 5.0Vin 3.3V Out.

TYPICAL EFFICIENCY CURVES FOR VARIOUS VOLTAGE MODELS SIP/SMT VERSION.

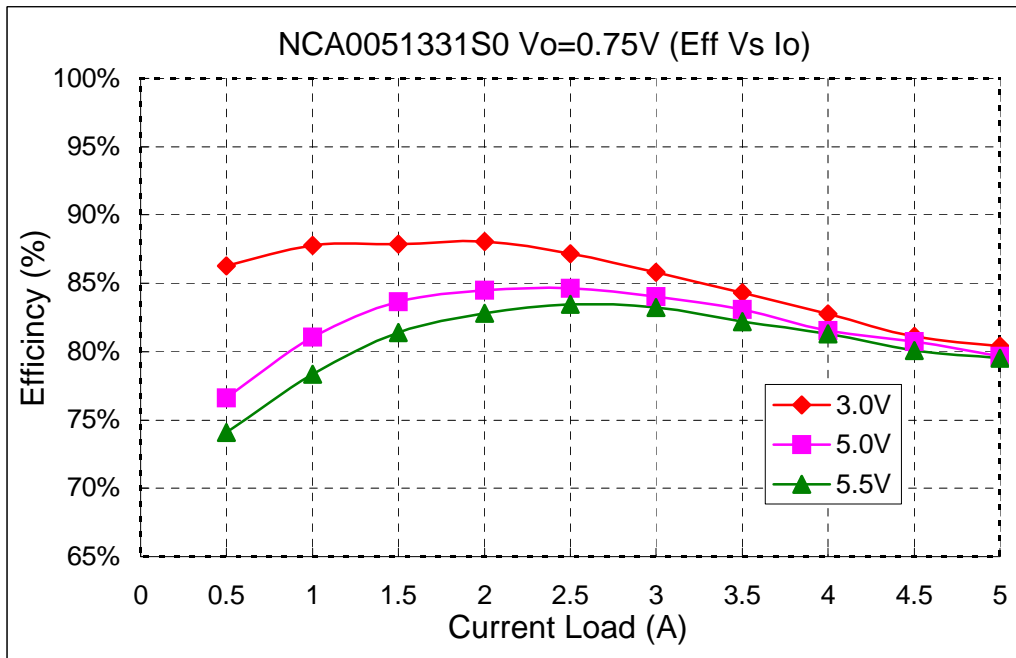

Fig 18. SMT Efficiency Curves for Vout=0.75V (25C)

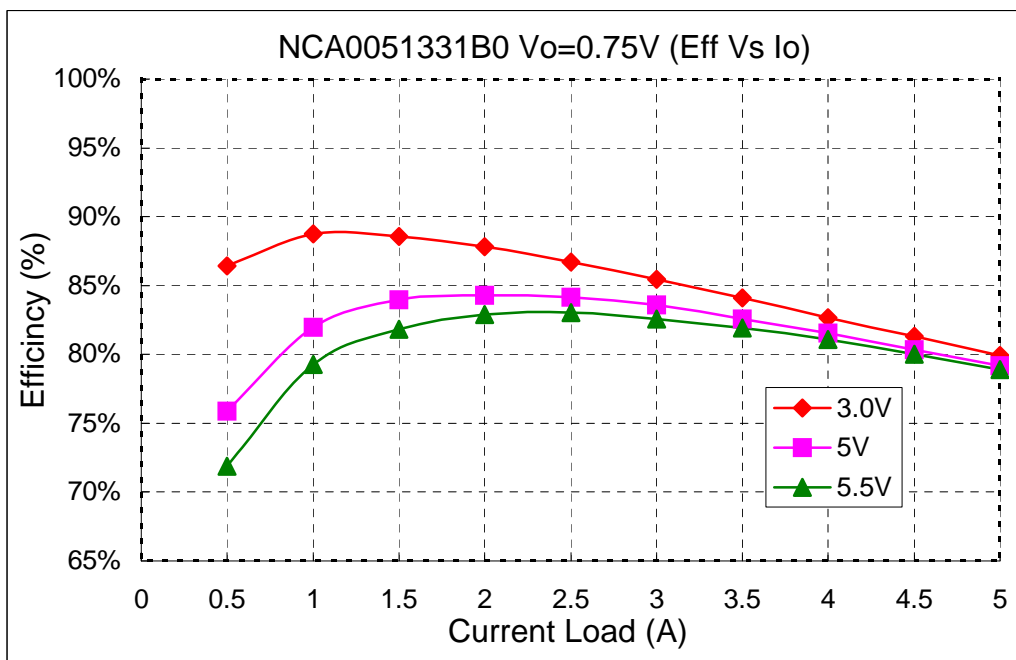

Fig 19. SIP Efficiency Curves for Vout=0.75V (25C)

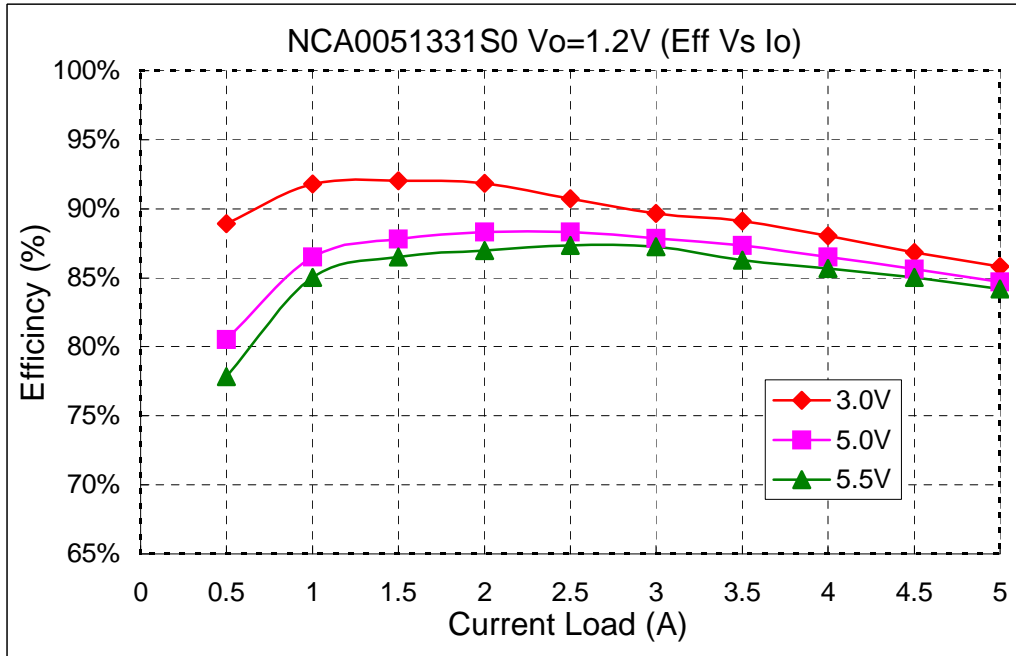

Fig 20. SMT Efficiency Curves for Vout=1.2V (25C)

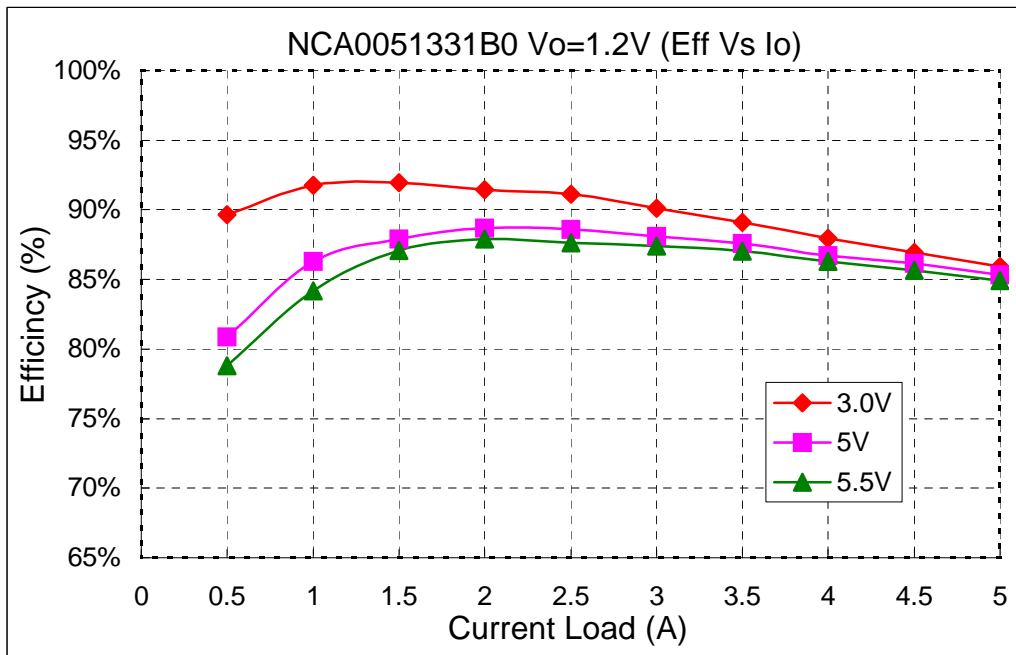

Fig 21. SIP Efficiency Curves for Vout=1.2V (25C)

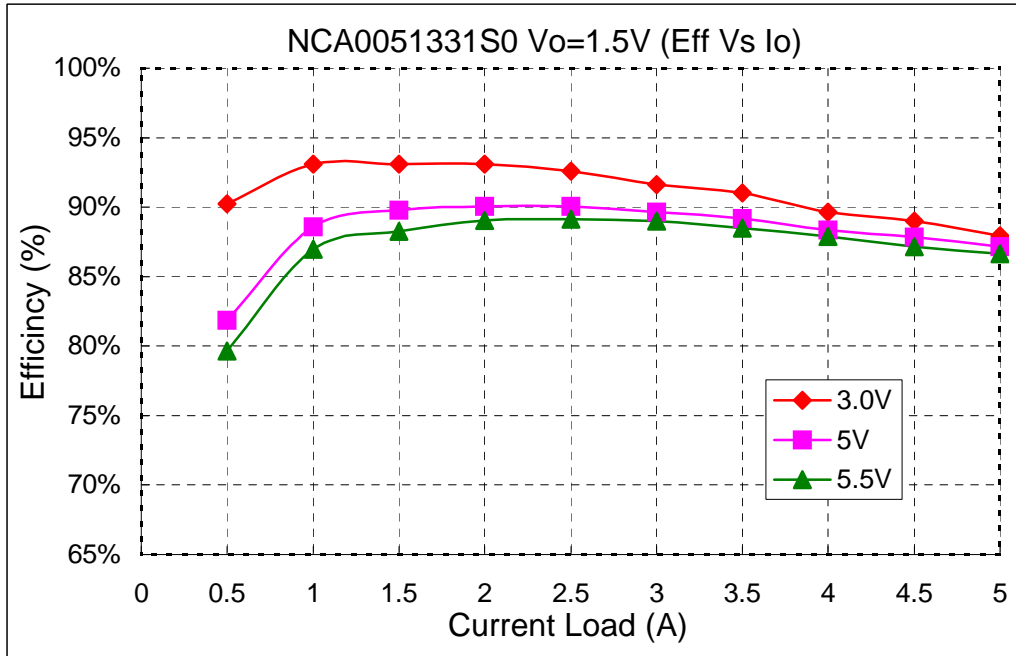

Fig 22. SMT Efficiency Curves for Vout=1.5V (25C)

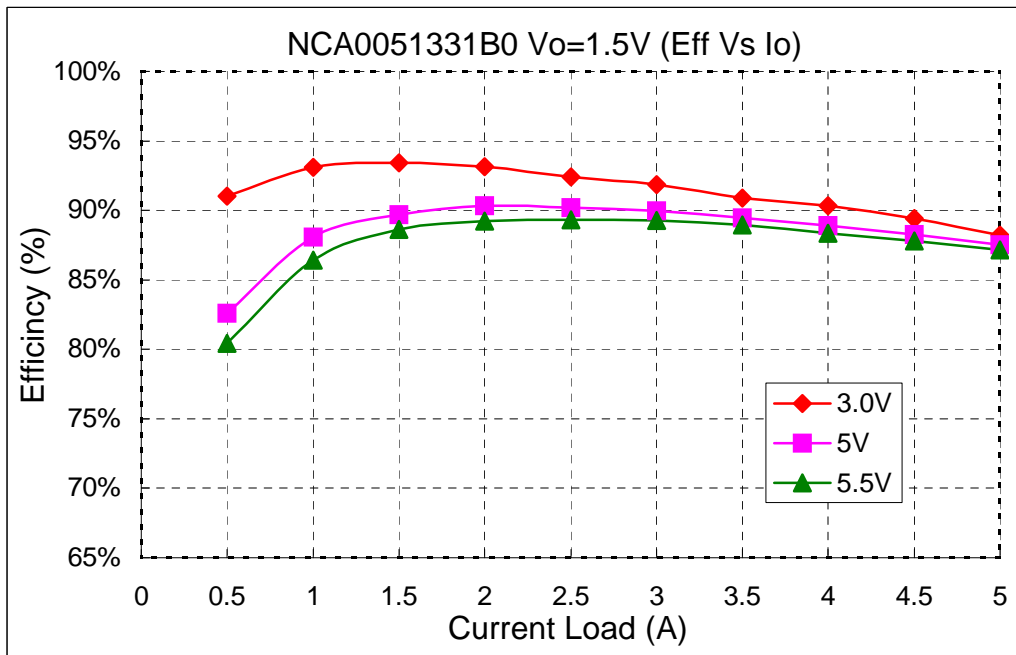

Fig 23. SIP Efficiency Curves for Vout=1.5V (25C)

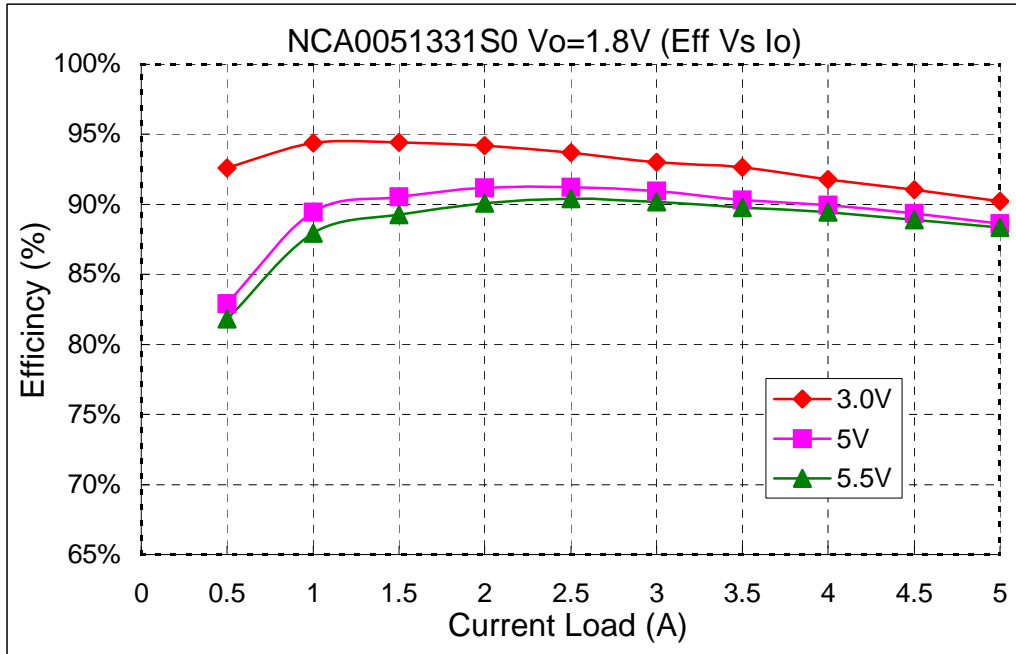

Fig 24. SMT Efficiency Curves for Vout=1.8V (25C)

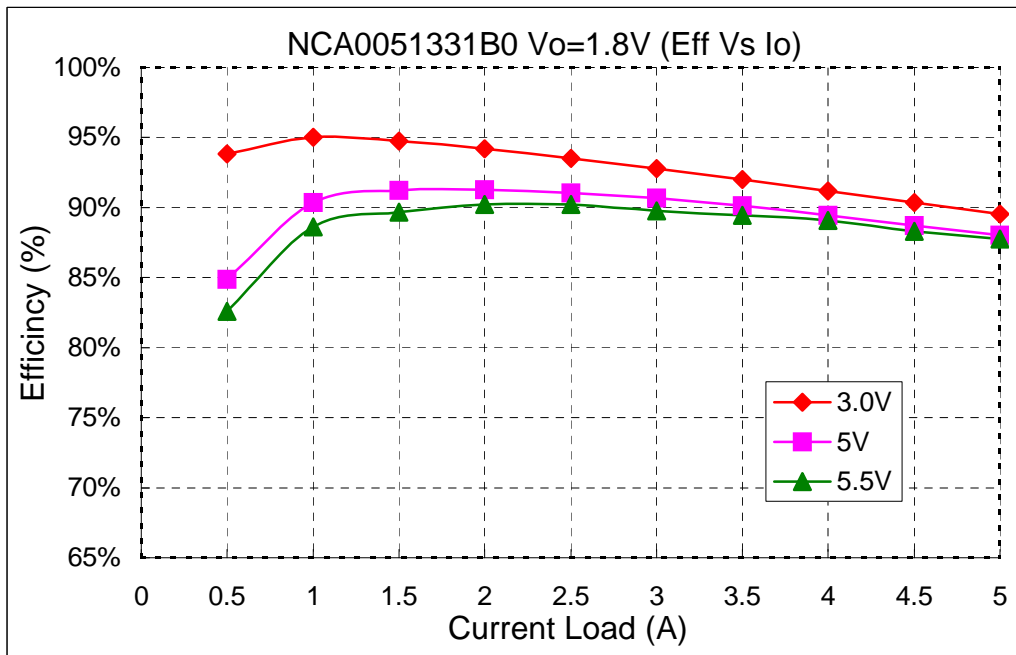

Fig 25. SIP Efficiency Curves for Vout=1.8V (25C)

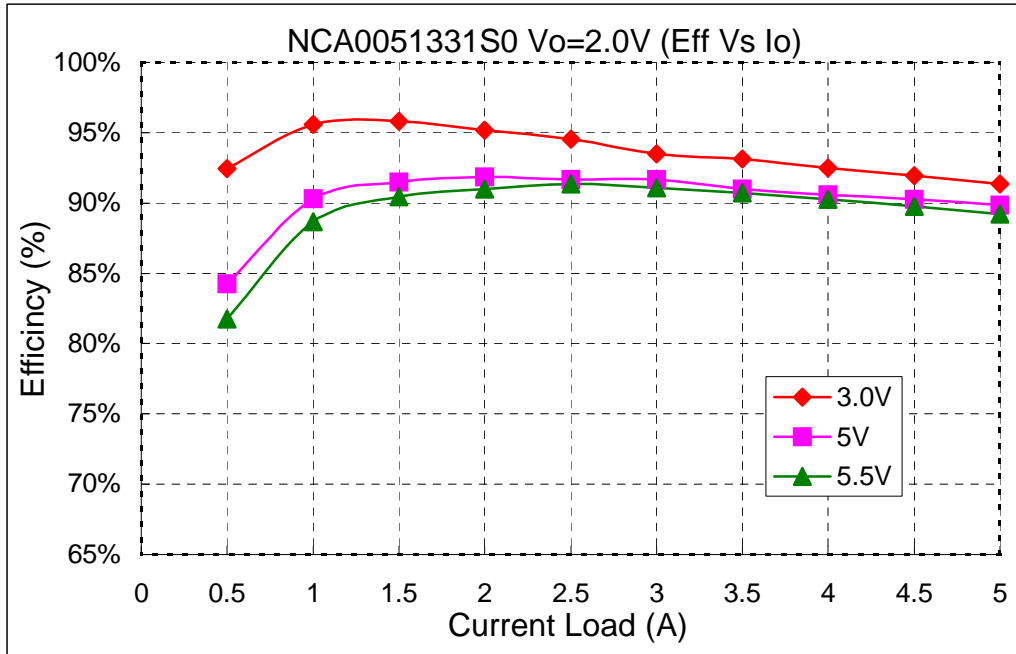

Fig 26. SMT Efficiency Curves for $V_{out}=2.0V$ (25C)

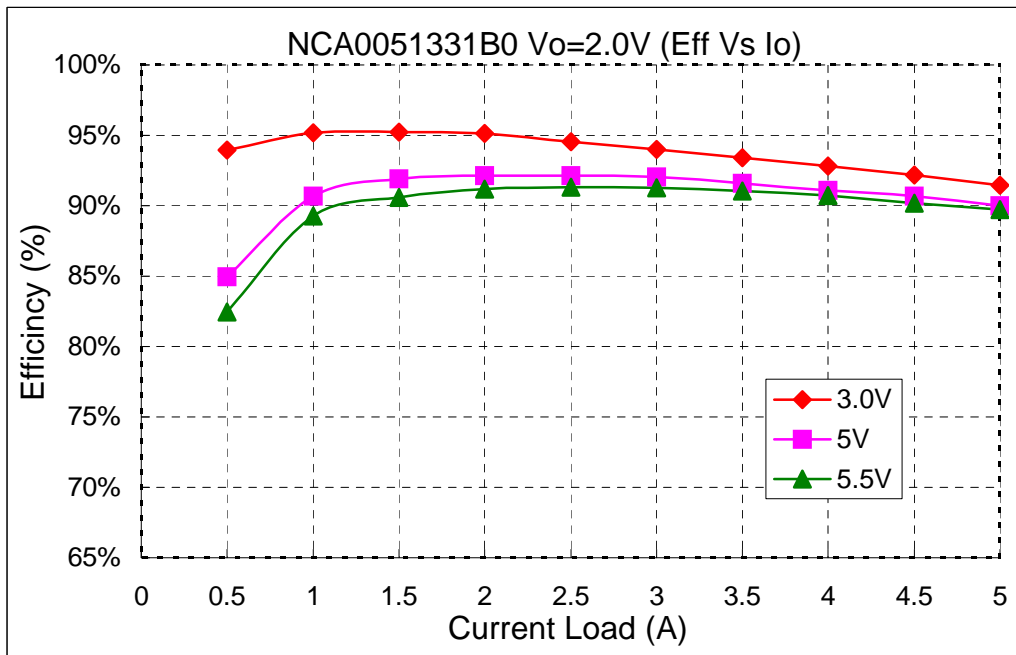

Fig 27. SIP Efficiency Curves for $V_{out}=2.0V$ (25C)

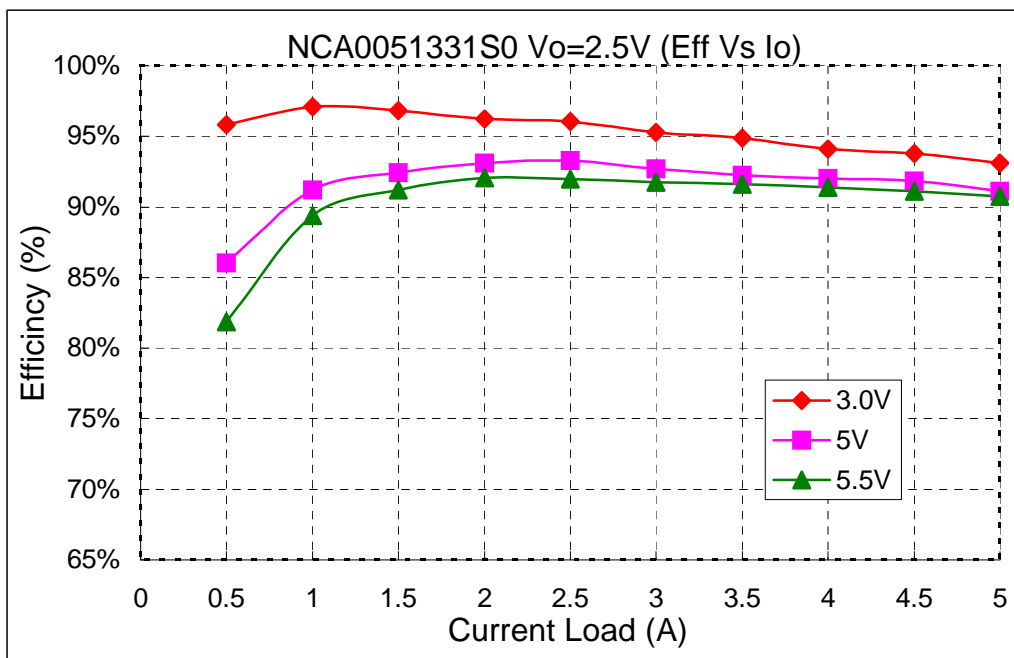

Fig 28. SMT Efficiency Curves for Vout=2.5V (25C)

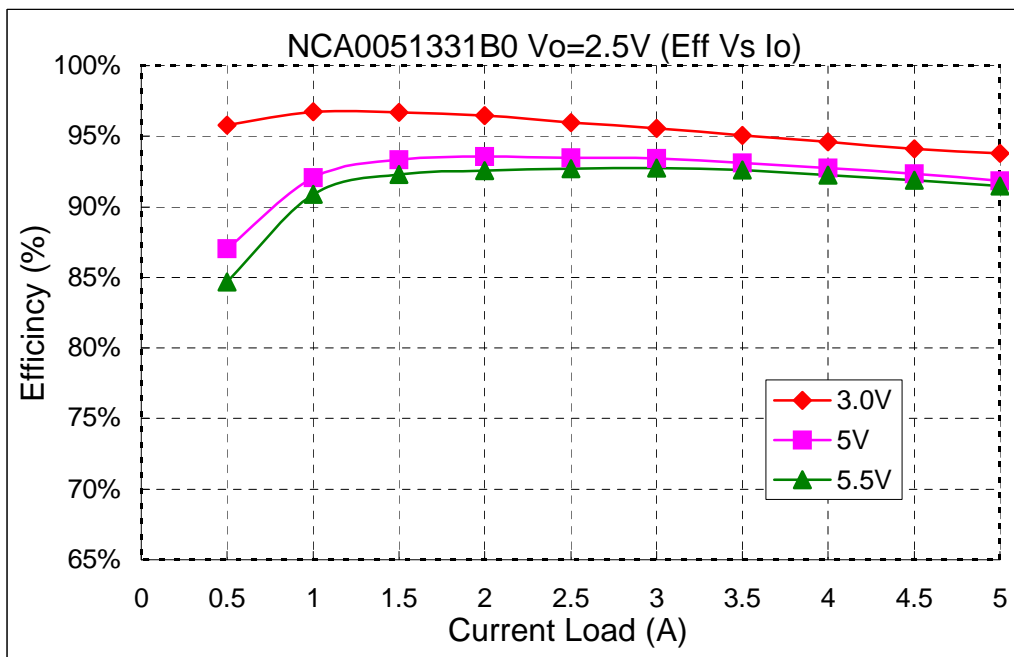

Fig 29. SIP Efficiency Curves for Vout=2.5V (25C)

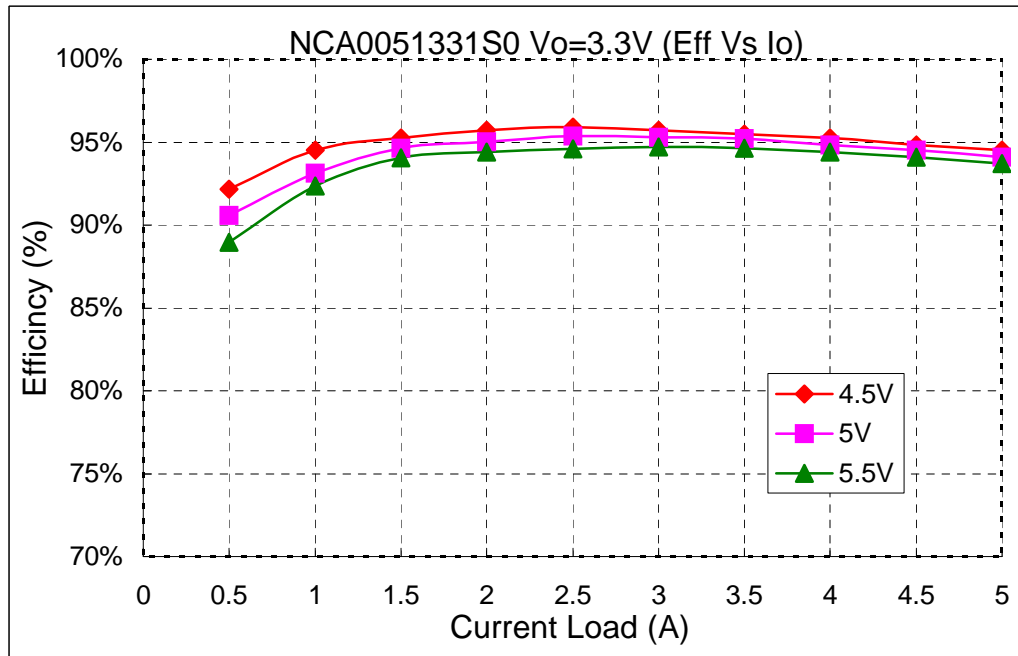

Fig 30. SMT Efficiency Curves for Vout=3.3V (25C)

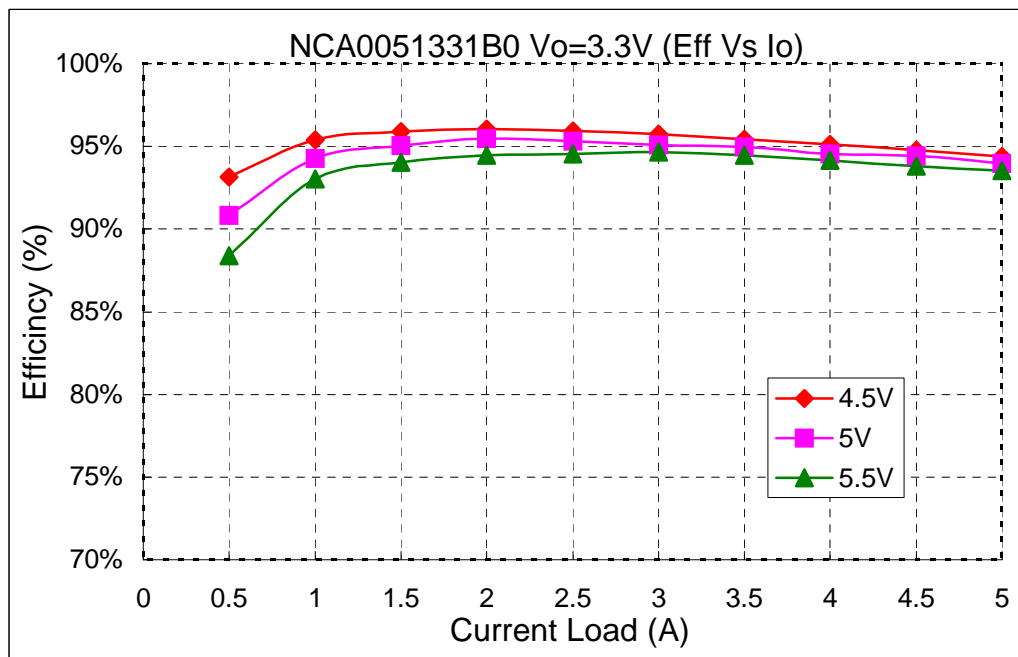
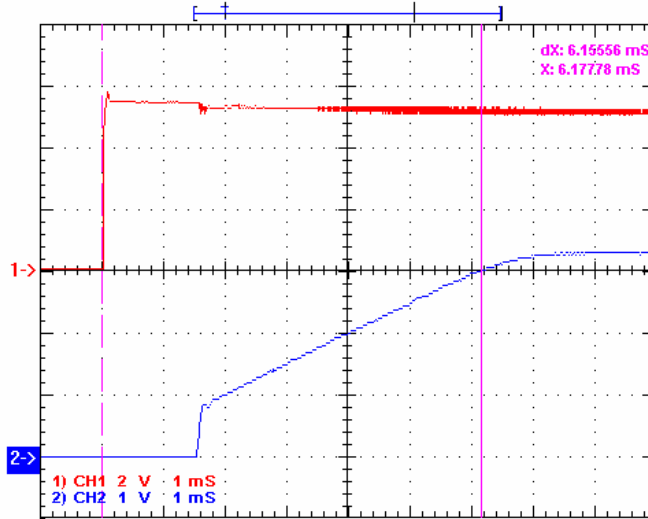
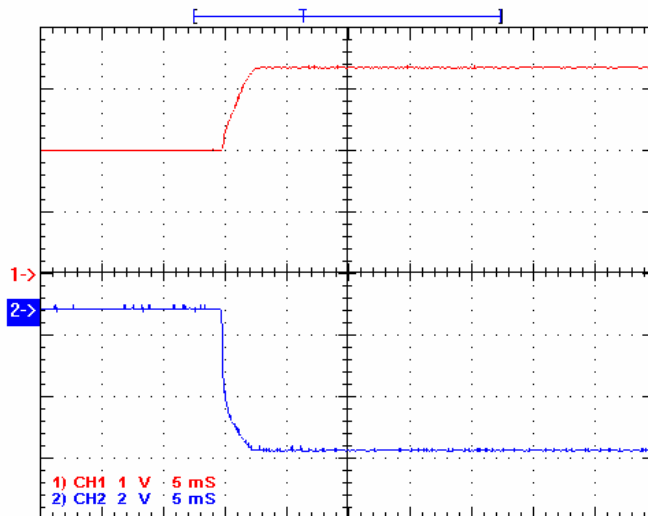

Fig 31. SIP Efficiency Curves for Vout=3.3V (25C)

Typical Start Up
 Ch1. Vin=5.0Vdc
 Ch2. Vout=3.3V, Full load.



Typical Start Up with pre-bias
 Vin=5Vdc
 Ch1 : Vout=3.3V
 Ch2 : Output current at Full Load



Typical Output Noise and Ripple

Vin = 5Vdc , Vo=3.3V/5A
 Output with 1uF ceramic and 10uF tantalum capacitor

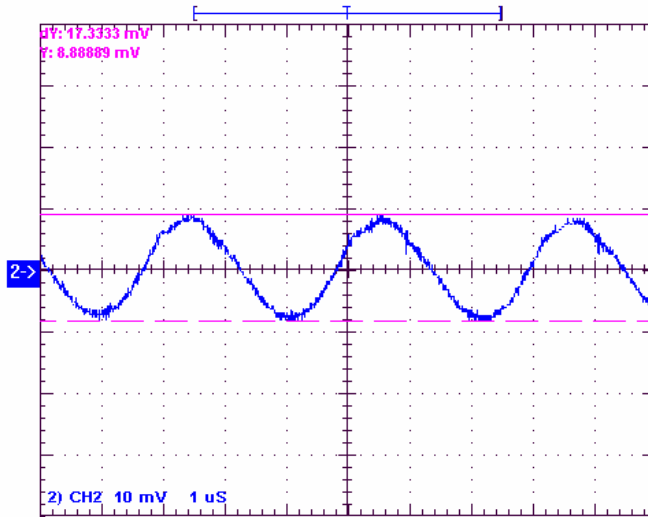

Typical Output Transient Response

Vin = 5Vdc , Vo=3.3V , 50% - 100% - 50% Load change , @0.1A/uS

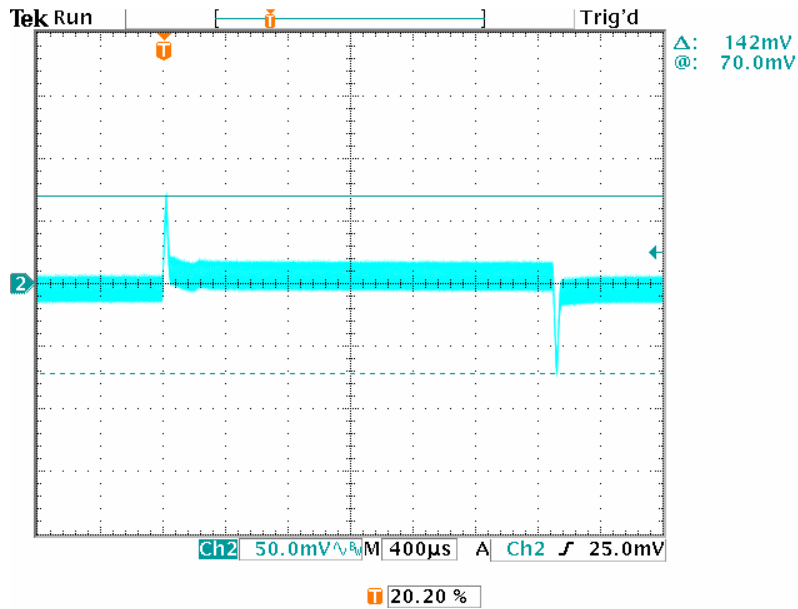

Output Voltage Set point adjustment.

The following relationship establish the calculation of external resistors:

$$R_{adj} = \frac{21070}{V_o - 0.7525} - 5110$$

For Vout setting an external resistor is connected between the TRIM and Ground Pin.

Resistor values for different output voltages are calculated as given in the table:

Vo, set (Volts)	RAdj (KΩ)
3.3	3.160
2.5	6.947
2.0	11.780
1.8	15.004
1.5	23.077
1.2	41.973
1.0	80.02
0.9	137.74
0.75	Open

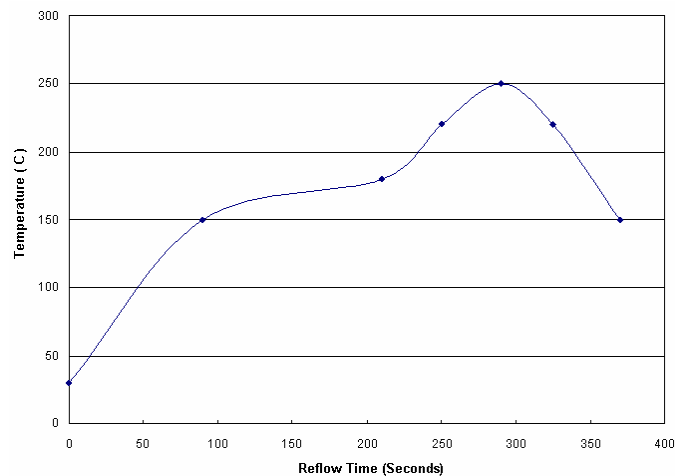
SMT Lead free Reflow profile

1. Ramp up rate during preheat : 1.33 °C/Sec (From 30°C to 150°C)
2. Soaking temperature : 0.29 °C/Sec (From 150°C to 180°C)
3. Ramp up rate during reflow : 0.8 °C/Sec (From 220°C to 250°C)
4. Peak temperature : 250°C, above 220°C 40 to 70 Seconds
5. Ramp up rate during cooling : -1.56 °C/Sec (From 220°C to 150°C)

Mechanical and pinning Information.

Given below is the outline drawing showing physical dimensions of the SIP & SMT package.

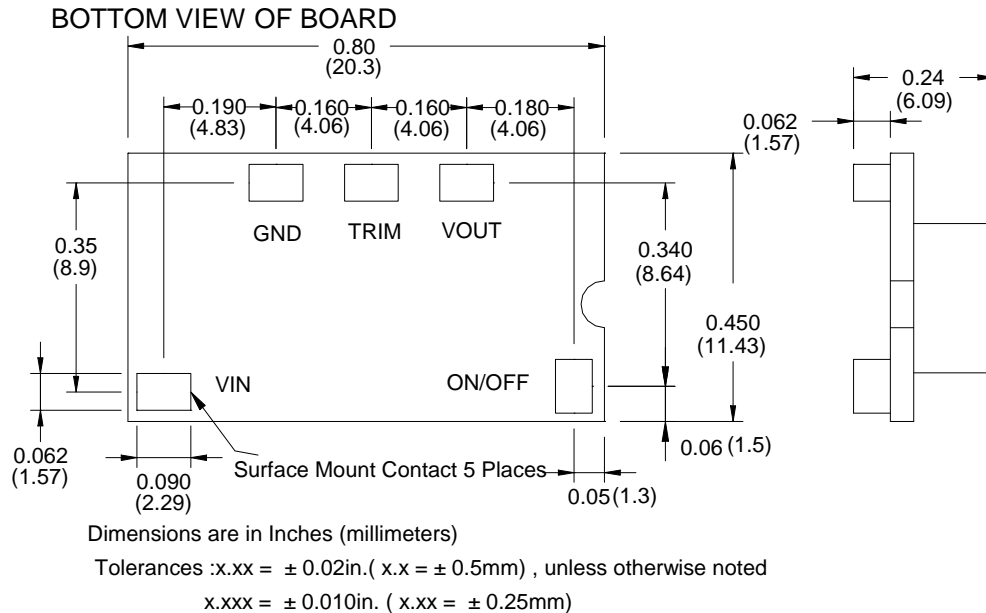

The external dimensions for SMT package are 20.3mm x 11.43mm x 6.09mm.

Recommended Pad Layout

Dimensions are in Inches (millimetres)

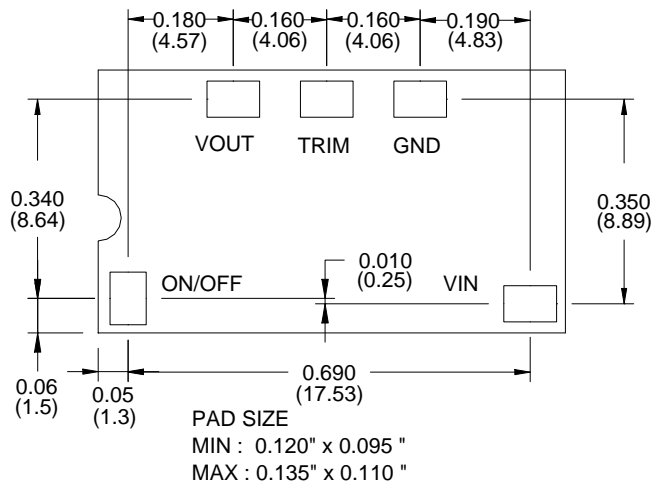

Whereas, the external dimensions of the SIP version are 22.9mm x 10.16mm x 5.6mm.

SIZE SIP05

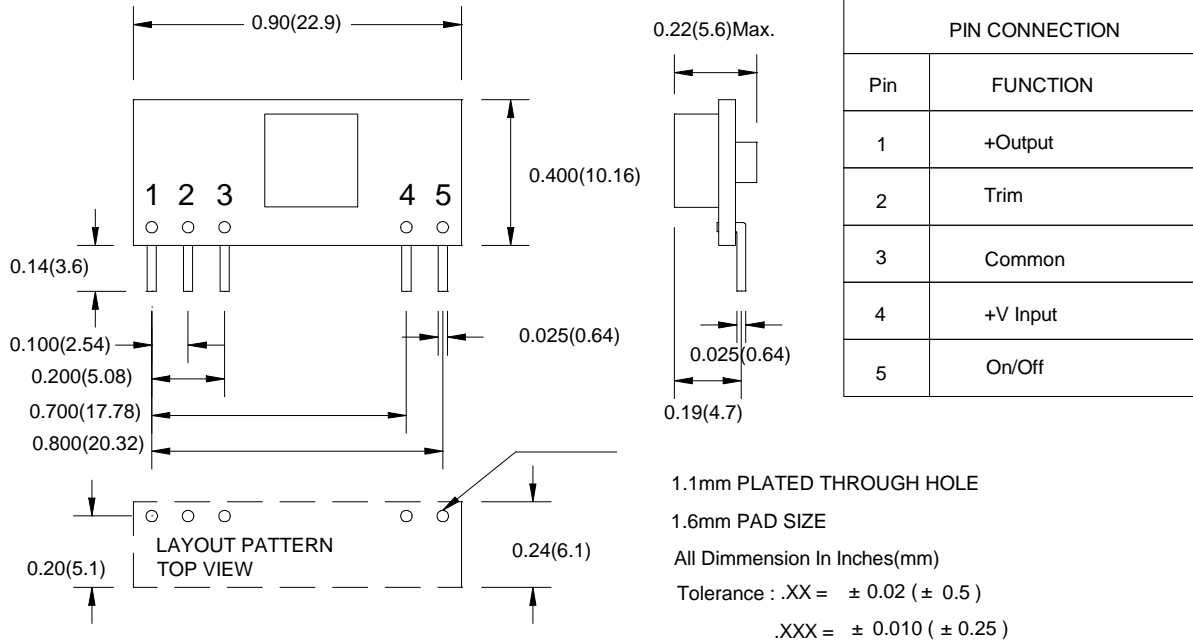

Safety Considerations

The NCA series of converters are certified to IEC/EN/CSA/UL 60950. If this product is built into information technology equipment, the installation must comply with the above standard.
An external input fuse of less than 50 Amps (5A to 30A recommended), must be used to meet the above requirements.
The output of the converter [Vo(+)/Vo(-)] is considered to remain within SELV limits when the input to the converter meets SELV or TNV-2 requirements.
The converters and materials meet UL 94V-0 flammability ratings.

Ordering Information

Part Number	Vin	Vout	Iout	Enable Logic	Pin Length
NCA0051330B0C	3.0V - 5.5V	0.75V - 3.6V	5A	Negative	0.139"
NCA0051330S0C	3.0V - 5.5V	0.75V - 3.6V	5A	Negative	SMT
NCA0051331B0C	3.0V - 5.5V	0.75V - 3.6V	5A	Positive	0.139"
NCA0051331S0C	3.0V - 5.5V	0.75V - 3.6V	5A	Positive	SMT





Label Information

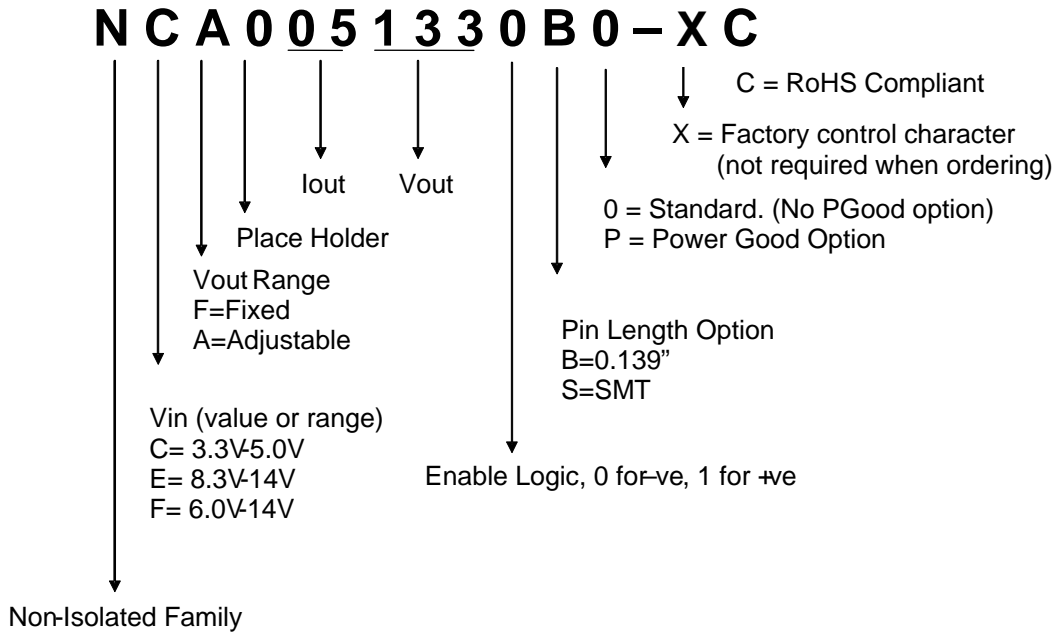

RoHS Compliant

The NCA005 series of converters is in compliance with the European Union Directive 2002/95/EC (RoHS) with respect to the following substances: lead (Pb), mercury (Hg), cadmium (Cd), hexavalent chromium, polybrominated biphenyls (PBB) or polybrominated diphenyl ethers (PBDE).



Murata Power Solutions, Inc.
11 Cabot Boulevard, Mansfield, MA 02048-1151 U.S.A.
Tel: (508) 339-3000 (800) 233-2765 Fax: (508) 339-6356
www.murata-ps.com email: sales@murata-ps.com ISO 9001 REGISTERED

Murata Power Solutions, Inc. makes no representation that the use of its products in the circuits described herein, or the use of other technical information contained herein, will not infringe upon existing or future patent rights. The descriptions contained herein do not imply the granting of licenses to make, use, or sell equipment constructed in accordance therewith. Specifications are subject to change without notice.

© 2008 Murata Power Solutions, Inc.

USA: Mansfield (MA), Tel: (508) 339-3000, email: sales@murata-ps.com
Canada: Toronto, Tel: (866) 740-1232, email: toronto@murata-ps.com
UK: Milton Keynes, Tel: +44 (0)1908 615232, email: mk@murata-ps.com
France: Montigny Le Bretonneux, Tel: +33 (0)1 34 60 01 01, email: france@murata-ps.com
Germany: München, Tel: +49 (0)89-544334-0, email: munich@murata-ps.com
Japan: Tokyo, Tel: 3-3779-1031, email: sales_tokyo@murata-ps.com
Osaka, Tel: 6-6354-2025, email: sales_osaka@murata-ps.com
Website: www.murata-ps.jp
China: Shanghai, Tel: +86 215 027 3678, email: shanghai@murata-ps.com
Guangzhou, Tel: +86 208 221 8066, email: guangzhou@murata-ps.com