

PART NUMBER: AMT203**DESCRIPTION: 12 BIT ABSOLUTE ENCODER**

THE AMT203 is a high performance absolute encoder based on capacitive sensing technology. The AMT203 utilizes a custom ASIC to create absolute position over a single turn. This encoder is 12 bit and communicates via an SPI serial bus for working as a slave to an external microprocessor. Incremental A,B signals with a single index pulse per 360 deg are provided for higher speed operation.

FEATURES

- 12 bit (4096 positions)
- SPI communication
- Small Size 37mm
- Incremental Line count up to 1024
- Single pulse index
- Capacitive ASIC technology
- Modular locking hub design for ease of installation
- SPI adjustable settings
- 'One Touch' zero position

**ELECTRONIC SPECIFICATIONS**

parameter	conditions/description	min	nom	max	units
power supply		4.5	5	5.5	V
current consumption			8	10	mA
output resolution			4,096		incr.
quadrature resolution	96, 192, 200, 250, 400, 500, 512, 1024				
incremental output signals	Quadrature A, B signals and Index Z				
incremental output waveform	square wave				
incremental outputs	output voltage - sourcing to +5 V @ -32 mA output voltage - sinking to ground @ -32 mA	3.8		0.55	V V
SPI output	natural binary				
SPI bus	PIC 16F690 (see datasheet)				
SPI resolution				12	bit
accuracy				2	incr.

MECHANICAL SPECIFICATIONS

parameter	conditions/description	min	nom	max	units
SPI speed				8,000	RPM
mounting options	A) 2 each M1.6 on 16 mm (0.63") bolt circle B) 2 each #4 on 19.05 mm (0.75") bolt circle C) 2 each M1.6 or M2 on 20 mm (0.787") bolt circle D) 3 each M1.6 or M2 on 20.9 mm (0.823") bolt circle with washers in option B holes E) 3 each M1.6 or M2 on 22 mm (0.866") bolt circle F) 4 each M1.6 or M2 on 25.4 mm (1") bolt circle				









ENVIRONMENTAL SPECIFICATIONS

parameter	conditions/description	min	nom	max	units
operating temperature		-40		125	°C
humidity				85	%RH
vibration	1.5mm, 3 directions, 2 hours	10		55	Hz

PART NUMBER: AMT203
DESCRIPTION: 12 BIT ABSOLUTE ENCODER

AMT203-V KIT

In order to provide maximum flexibility for our customers, the AMT203 series is provided in kit form standard. This allows the user to implement the encoder into a range of applications using one sku#, reducing engineering and inventory costs.

SLEEVES								
								
8mm	1/4 inch (6.35mm)	6mm	5mm	3/16 inch (4.76mm)	4mm	1/8 inch (3.175mm)	3mm	2mm
Blue	Snow	Red1	Green1	Yellow1	Gray60	Purple1	Orange	Light Sky Blue

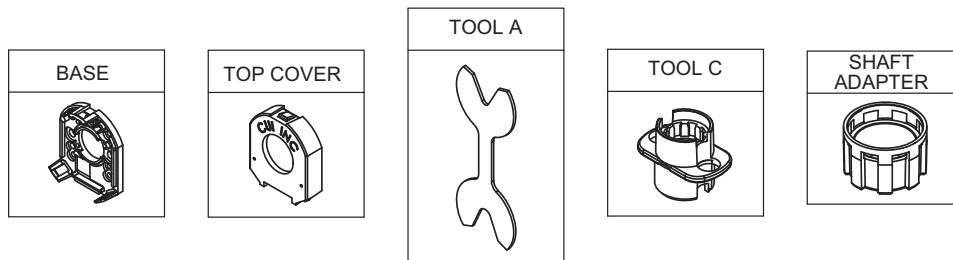

CUSTOM CONFIG KEY

The AMT203 is designed for 12 bit binary (4.096) operation. For customers who may use the optional quadrature output, one of the resolutions below may be selected as the default quadrature output.

AMT203 - XXXX - XXXX

Resolution (ppr):

0096
0192
0200
0250
0400
0500
0512
1024

Sleeve Bore Diameter:

2000 = 2 mm
3000 = 3 mm
3175 = 3.175 mm (1/8")
4000 = 4 mm
4760 = 4.76 mm (3/16")
5000 = 5 mm
6000 = 6 mm
6350 = 6.35 mm (1/4")
8000 = 8 mm

PART NUMBER: AMT203
DESCRIPTION: 12 BIT ABSOLUTE ENCODER
ENCODER INTERFACE

PINOUT CONNECTOR 1	
#	FUNCTION
14	T_Bit
13	N/A
12	X
11	N/A
10	A
9	N/A
8	B
7	MOSI
6	5 V+
5	SCK
4	GND
3	MISO
2	CSB
1	N/A

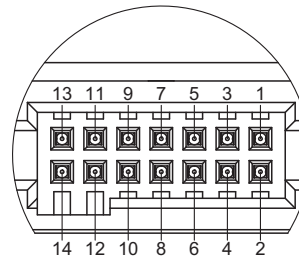
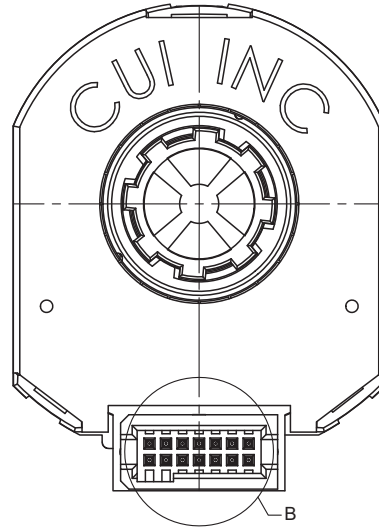
 DETAIL B
SCALE 4 : 1

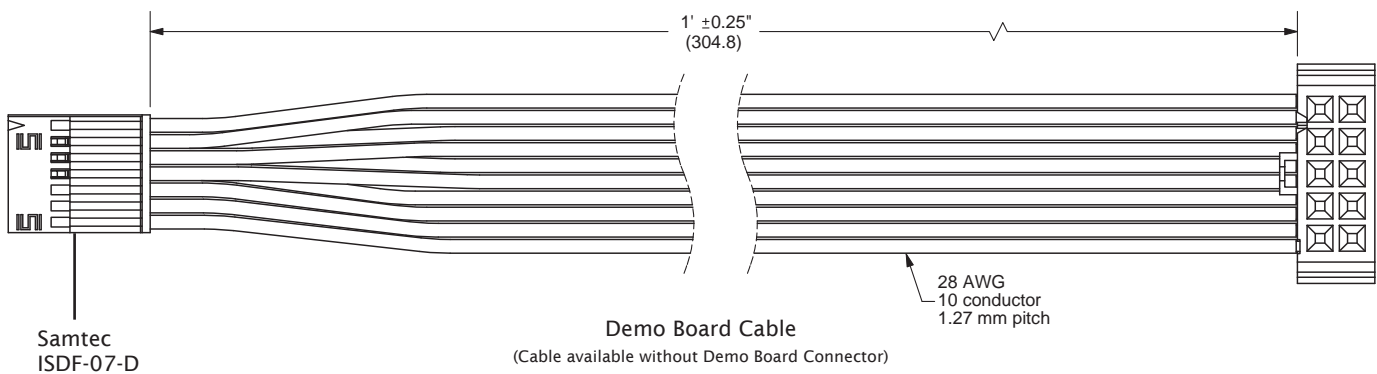
Encoder Side
Demo Board Side

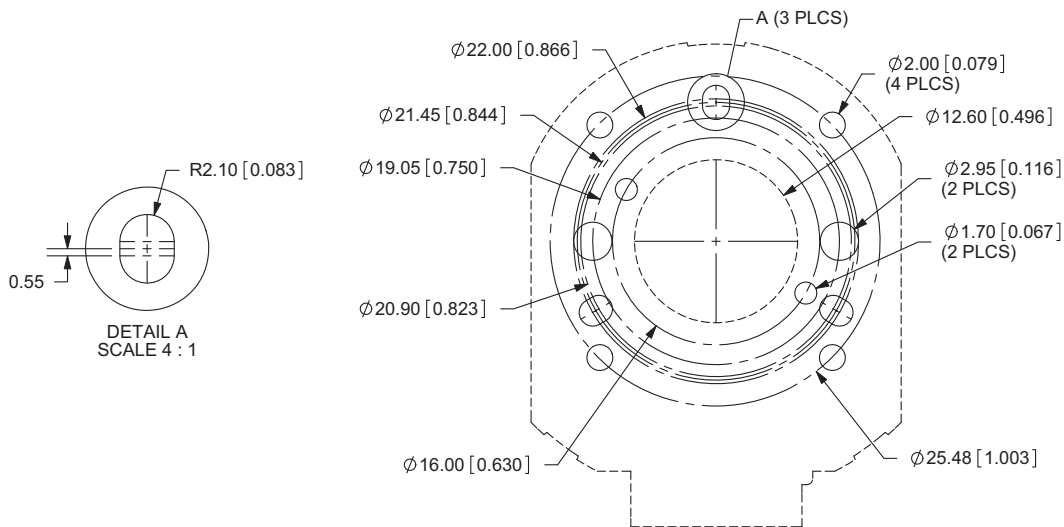
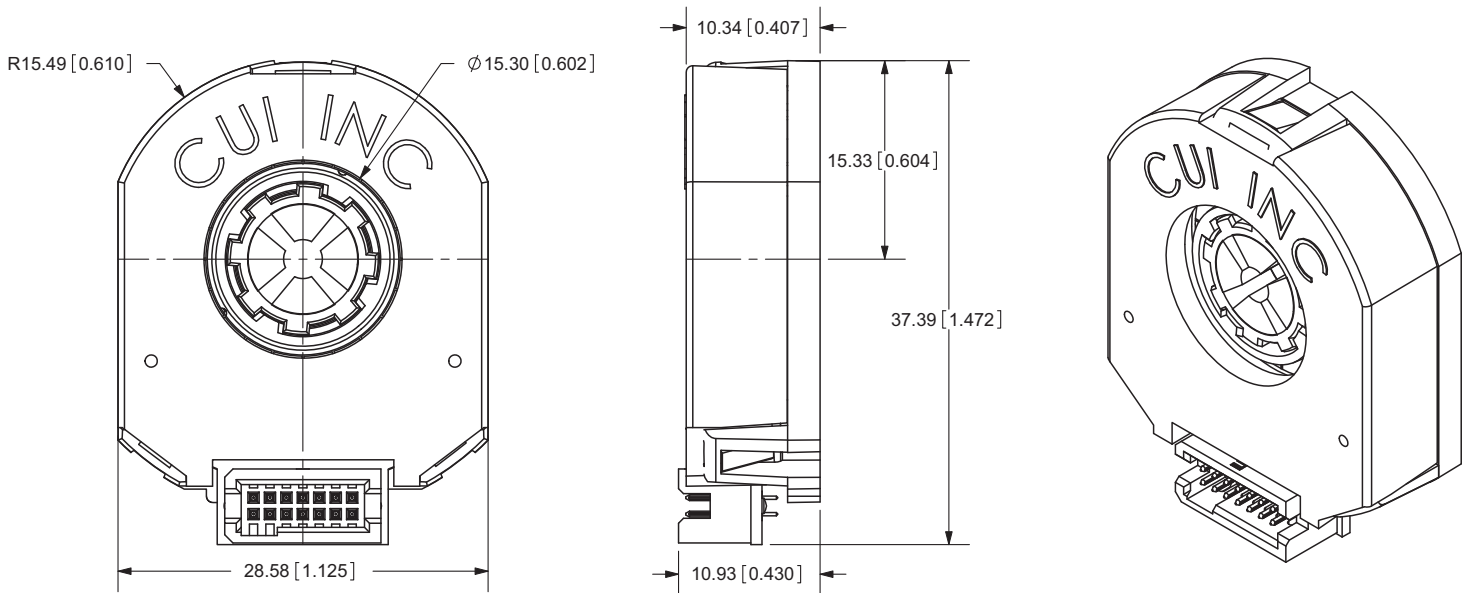
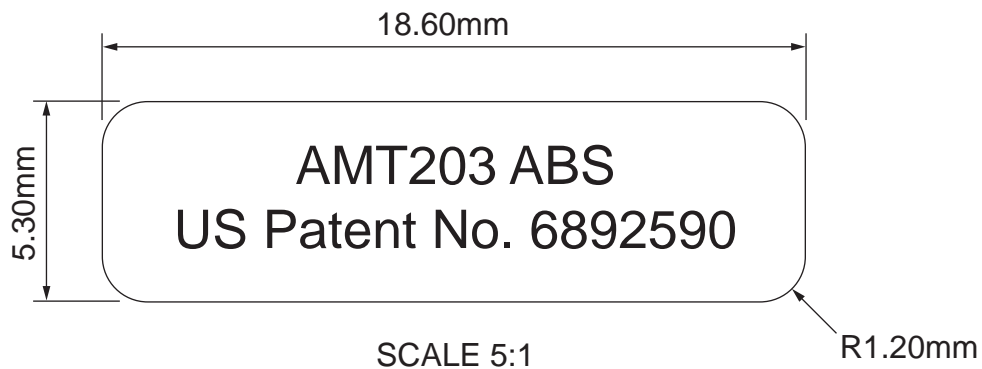
PART NUMBER: AMT203
DESCRIPTION: 12 BIT ABSOLUTE ENCODER

 TOLERANCE:
 $\pm 0.05\text{mm}$ UNLESS OTHERWISE
 SPECIFIED

PART NUMBER: AMT203
DESCRIPTION: 12 BIT ABSOLUTE ENCODER

APPLICATION NOTES

Encoder operational mode

- **Initialization mode:** At power up the encoder goes through an initiation and stabilization procedure. This includes microprocessor stabilization and the program for combining Coarse and Fine channel of the encoder for getting the absolute start position. This takes less than 0.1 seconds.
- **Tracking mode:** Only the Fine channel is active and the MCU internal position register is updated with data from Fine:
 - MCU 12 bit position register is updated from Fine every 48 μ s.
 - For accurate position update without above time delay, outputs for incremental A quad B or Count and Up/Dwn from the Fine channel are provided. These outputs are operational up to 8000 RPM and there is no speed error. There is an acceleration error dependent on an internal filter constant of about 100 μ s.
 - When using the incremental output there also is an Index output available, with one index pulse per turn.

Serial Peripheral Interface Commands

The SPI or Serial Peripheral Interface Bus is a standard interface promoted by Motorola and Microchip among others. It consists of 4 signals:

MOSI: Master Out Slave In
 MISO: Master In Slave Out
 SCK: Serial Clock
 CSB: Chip Select (active low)

SPI BUS

The SPI bus runs full duplex and transfers multiples of 8 bits in a frame. The SPI type is the most common (CPOL=0, CPHA=0), also known as Microwire. Data is captured on the rising edge of SCK and the output data is changed after the falling edge of SCK.

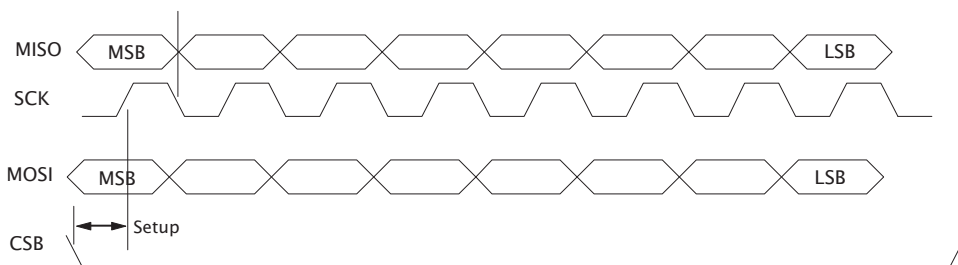

Terminology

MSB = most significant byte
 LSB = least significant byte
 msb = most significant bit
 lsb = least significant bit

Serial Peripheral Interface Bus (SPI) on AMT203

Figure 7: SPI BUS Timing Diagram

The msb data out on MISO is valid soon after CSB goes low. The MOSI data is valid soon after the falling edge of SCK. The Encoder drives data out on MISO as long as CSB is low.

Normally, CSB goes low, then after 8 clocks the command is interpreted. CSB high resets the clock counter, and terminates any command sequence.

PART NUMBER: AMT203**DESCRIPTION: 12 BIT ABSOLUTE ENCODER**

SPI Commands:

The commands are all 8 bits long, the msb is shifted in first, and is the leftmost bit shown in Figure 7.

Encoder Protocol Considerations:

The Encoder is designed to operate with a high speed SPI link, in full duplex mode. This implies the host can issue commands and read data as quickly as necessary but there has to be an acknowledgement from the slave just before the data is transferred.

Essentially the host issues a command, receives zero or more wait sequences (0xA5 or 1010,0101) then the echo of the command followed by an optional payload.

So, for example to read the position, the host issues rd_pos (0x10 or 0001,0000), receiving a series of wait sequences (0xA5) then a reflected rd_pos (0x10), then the MSB data followed by the LSB data.

It is recommended that the host leave a 20 us gap between reads to avoid extending the read time by forcing wait sequences.

Command 0x00: nop_a5

This command is ignored by the Encoder and simply causes the next data to be read. The encoder responds with 0xA5 if there is nothing else to send.

Command 0x10: rd_pos

This command causes a read of the current position.

The sequence is as follows:

- 1) issue read command, receive idle character
- 2) issue NOP, receive idle character 0xA5 or 0x10
- 3) repeat step 2 if it is 0xA5
- 4) issue NOP and receive MSB position (4 bits valid data)
- 5) issue NOP and receive LSB position (8 bits valid data)

Note that it is possible to overlap commands, so instead of NOP is several steps above the user could start another operation. The read and write FIFOs for the PCI streams are 16 bytes long and it is up to the user to avoid overflow.

Command 0x70: set_zero_point

This command sets the current position to zero and saves this setting in the EEPROM. The host should send nop_a5 repeatedly after sending this command, the response will be 0xA5 while update is proceeding and 0x80 is the response when update is finished.