 毫欧电阻 毫欧制造	HoLR2512封体合金系列规格书	系列号	HoLR
		修订日期	2020-05-25
		版本号	Ho-A0



规格书 Specification

制造商:深圳市毫欧电子有限公司

HoLR2512

适用:本规格书适用于深圳市毫欧电子有限公司封体合金电阻 HoLR2512系列产品选型。

■ 产品特点 Features

- 合金芯片, 封体工艺, 焊接性能良好
- 高可靠性, 高过载能力, 产品精度高。
- 使用温度范围较宽无感型设计
- 电阻温度系数 $TCR \times 10^{-6}/^{\circ}C \pm 50ppm \pm 75ppm$
- 符合 ROHS 要求和无卤要求

■ 产品名称 Product Name

封体合金电阻

■ 产品型号 Product number

Ho	LR	2512	2W	100mR	1%
↓	↓	↓	↓	↓	↓
制造商	产品类别	封装	额定功率	阻值	精度
毫欧电子	封体合金	2512	1W/1.5W 2W/3W	1mR~100mR	D=±0.5% F=±1% J=±5%
			1W/1.5W/2W	100mR~500mR	

具体参数请查看下页详情



地址: 深圳市龙华新区观澜大布头路南通邦高新产业园 A 栋 8 楼



毫欧电阻 毫欧制造

HoLR2512封体合金系列规格书

系列号	HoLR
修订日期	2020-05-25
版本号	Ho-A0

■ 产品结构及尺寸 Product structure and size (Unit:mm)

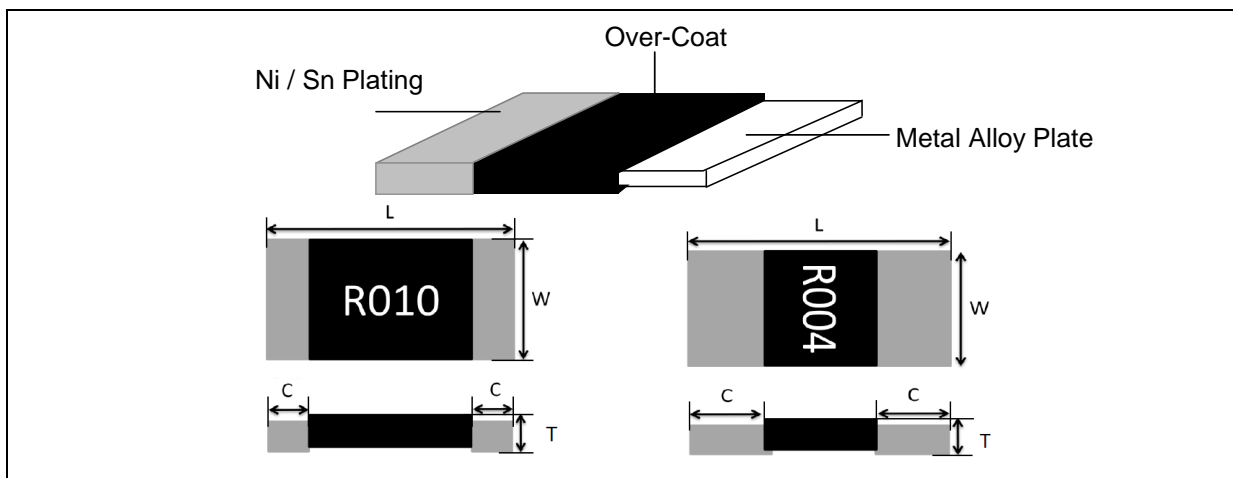

封装	阻值	L	W	C	T
2512	1mR~4mR	6.4±0.2	3.2±0.2	2.0±0.2	0.7±0.2
	5mR~500mR	6.4±0.2	3.2±0.2	0.9±0.2	0.7±0.2

■ 电气参数 Electrical parameter

额定功率 Rated power	1mΩ ≦ R ≦ 100mΩ (1W、1.5W、2W、3W) 100mΩ < R ≦ 500mΩ (1W、1.5W、2W)
阻值范围 Resistance range	1mR~500mR
最大额定电流 Max.Rated Current	1.41A~54.77A
准确度等级 Accuracy Class	0.5%、1%、5%
电阻温度系数 T.C.R (ppm / °C)	±50、±75
工作温度范围 Operating Temperature Range	-50°C~+170°C

■ 功率曲线 Power curve

操作温度范围 -50 ~ +170 °C 电阻温度达到 70°C 时降功率示意图

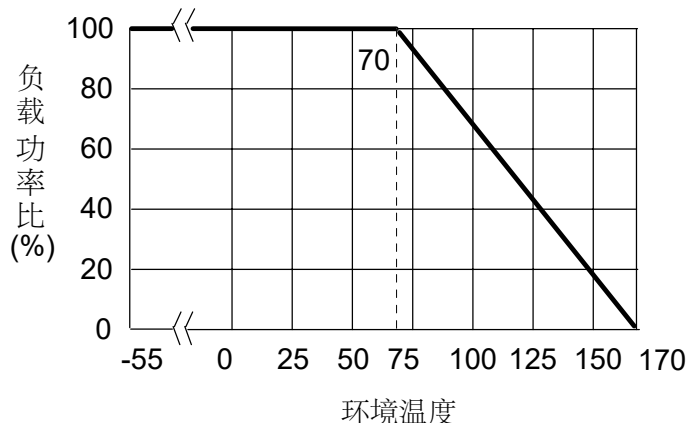

地址：深圳市龙华新区观澜大布头路南通邦高新产业园 A 栋 8 楼

系列号	HoLR
修订日期	2020-05-25
版本号	Ho-A0

■ 额定电流计算公式 The rated current is calculated by the following Formu

$$I = \sqrt{P/R}$$

I :Rated Current (A)

P:Rated Power (W)

R:Resistance Value (Ω)

■ 建议焊盘尺寸 Recommended Solder Pad Dimension (Unit:mm)

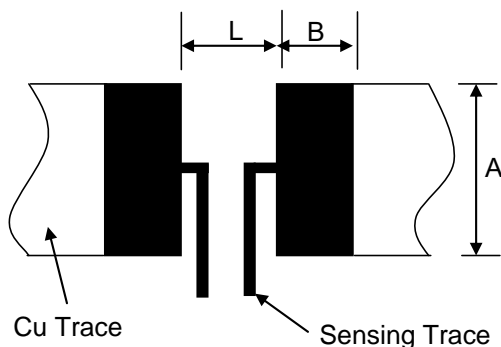

封装	阻值mR	A	L	B
2512	1~4	4.0	1.3	3.1
	5~500	4.0	4.1	2.1

■ 建议焊接参数 / Recommended Customer Soldering Parameters

预热: 150 to 180 C, 90 ± 30秒, 焊接区: 230 C 或更高, 30 ± 10 秒 峰值: 260 ± 5 C, 5秒.

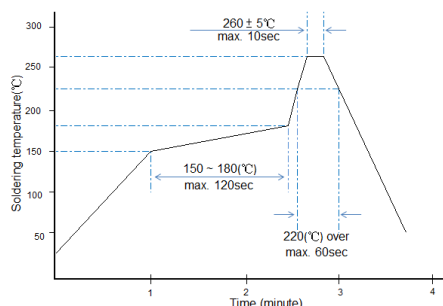

回流焊曲线图

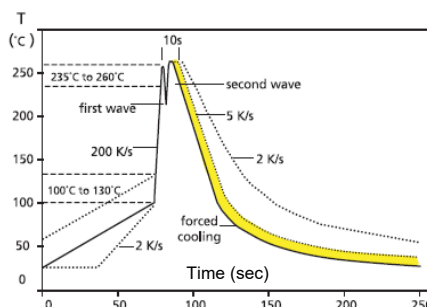

波峰焊曲线图

■ 彩带尺寸 Ribbon size(Unit:mm)

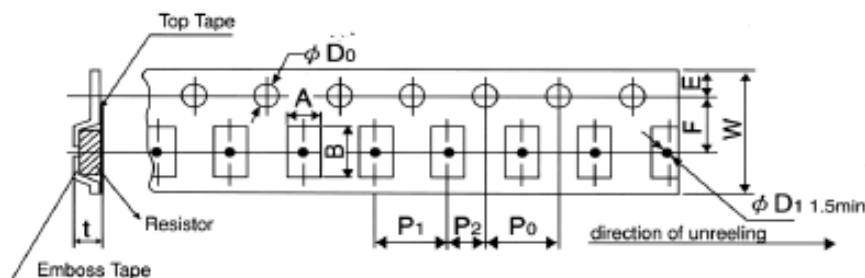

A	B	W	F	E	P1	P2	P0	D0	T
3.6±0.2	6.9±0.2	12±0.2	5.5±0.05	1.75±0.1	4.0±0.1	2±0.05	4±0.05	Φ 1.5±0.1	0.85±0.15

地址: 深圳市龙华新区观澜大布头路南通邦高新产业园 A 栋 8 楼



HoLR2512 封体合金系列规格书

系列号	HoLR
修订日期	2019-04-13
版本号	Ho-A0

■ 卷轴规格 Reel Specification

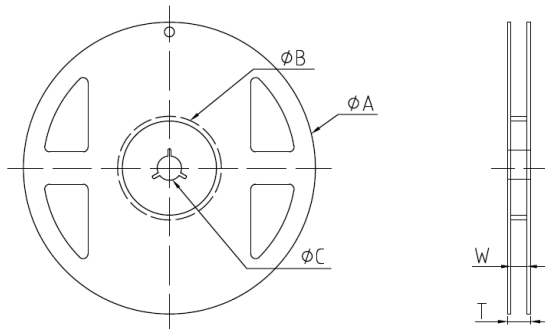

Φ A	Φ B	Φ C	W	T	Packaging Quantity
180+0/-3	60±1	13±1	13±1	15.4±2	4000PCS

■ 可靠性测试 Reliability Tests

Test Items	Reference standard	Condition of Test	Test Limits
Temperature Coefficient of Resistance	IEC60115-1-4.8 JIS-C5201-4.8	+25°C ~ +125°C	Refer 4.0
Load Life	IEC60115-1-4.25.1 JIS-C5201-4.25.1	1000hours at rated power, 70°C, 1.5hours "ON", 0.5hour "OFF"	< ±1%
Short Time Overload	IEC60115-1-4.13 JIS-C5201-4.13	5 X rated power for 5s	< ±1%
Moisture no Load	IEC60115-1- 4.24.2.1a) JIS-C5201- 4.24.2.1a)	85°C, 85%RH, 1000hrs	< ±1%
Temperature cycle	IEC60115-1-4.19 JIS-C5201-4.19	-55°C & +155°C, 100cycle, 15min per extreme condition	< ±1%
Resistance to Soldering Heat	IEC60115-1-4.18 JIS-C5201-4.18	260±5°C for 10±1 sec	< ±0.5%
Solderability	IEC60115-1-4.17 JIS-C5201-4.17	245±5°C, 2±0.5sec	At least 95% of surface area of electrode shall be covered with new solder
High Temperature Exposure	IEC60115-1- 4.23.2 JIS-C5201-4.23.2	155°C, 1000hrs	< ±1%
Low Temperature Storage	IEC60115-1- 4.23.4 JIS-C5201-4.23.4	-55°C, 1000hrs	<±1%
Substrate Bending	IEC60115-1-4.33 JIS-C5201-4.33	Bending width 2mm	< ±0.5%
Insulation Resistance	IEC60115-1-4.6 JIS-C5201-4.6	100V DC for 1 minute	>100 MΩ

地址：深圳市龙华新区观澜大布头路南通邦高新产业园 A 栋 8 楼