

PLEASE CHECK WWW.MOLEX.COM FOR LATEST PART INFORMATION

Part Number: [0399000503](#)
Status: **Active**
Description: 3.81mm (.150") Pitch Beau™ Eurostyle™ Vertical PCB Header, 3 Circuits
Replacement Part Number: 39511-1003

Documents:

[3D Model](#) [RoHS Certificate of Compliance \(PDF\)](#)
[Drawing \(PDF\)](#)

Agency Certification

UL E48521

General

Product Family Terminal Blocks
 Series [39900](#)
 Application Wire-to-Board
 Comments Gold plating and green housing available
 Component Type PCB Header
 Product Name Eurostyle™ Pluggable
 Replacement Part Number [39511-1003](#)
 Type Euro Block

Physical

Circuits (Loaded) 3
 Color - Resin Black
 Entry Angle N/A
 Flammability 94V-0
 Lock to Mating Part None
 Material - Plating Mating Gold
 Material - Plating Termination Gold
 Material - Resin Polyester
 Number of Rows 1
 Orientation Vertical
 PC Tail Length (in) 0.134 In
 PC Tail Length (mm) 3.40 mm
 PCB Retention N/A
 PCB Thickness Recommended (in) 0.093 In
 PCB Thickness Recommended (mm) 2.40 mm
 Panel Mount No
 Pitch - Mating Interface (in) 0.150 In
 Pitch - Mating Interface (mm) 3.81 mm
 Plating min: Mating (µin) 30
 Plating min: Mating (µm) 1.18
 Plating min: Termination (µin) 30
 Plating min: Termination (µm) 1.18
 Polarized to Mating Part Yes
 Shrouded Fully
 Stackable No
 Temperature Range - Operating 130°C
 Wire Size AWG N/A

Electrical

Current - Maximum per Contact 12A
 Voltage - Maximum 300V

Material Info

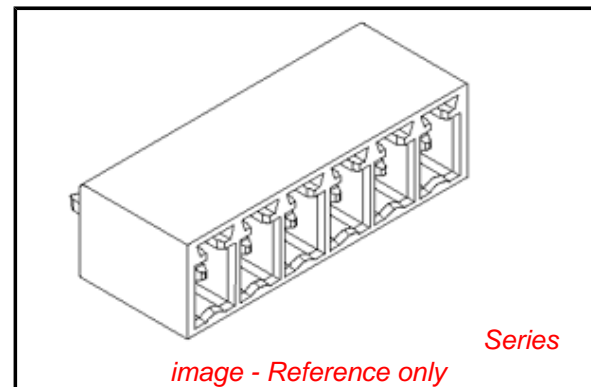

EU RoHS

ELV and RoHS Compliant
REACH SVHC
 Not Reviewed
Halogen-Free Status
Not Reviewed

China RoHS



Need more information on product environmental compliance?

Email productcompliance@molex.com
 For a multiple part number RoHS Certificate of Compliance, [click here](#)

Please visit the [Contact Us](#) section for any non-product compliance questions.

Search Parts in this Series

[39900Series](#)

Mates With

[39900-0303](#) Vertical Plug, Front Wire Entry,
[39900-0203](#) Vertical Plug, Rear Wire Entry,
[39905-0103](#) Horizontal Plug

Old Part Number

901603

Reference - Drawing Numbers

Sales Drawing

SD-39900-001

This document was generated on 04/27/2010

PLEASE CHECK WWW.MOLEX.COM FOR LATEST PART INFORMATION

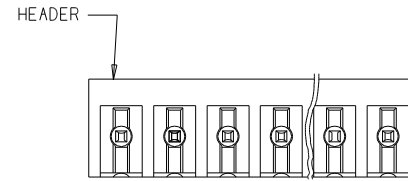
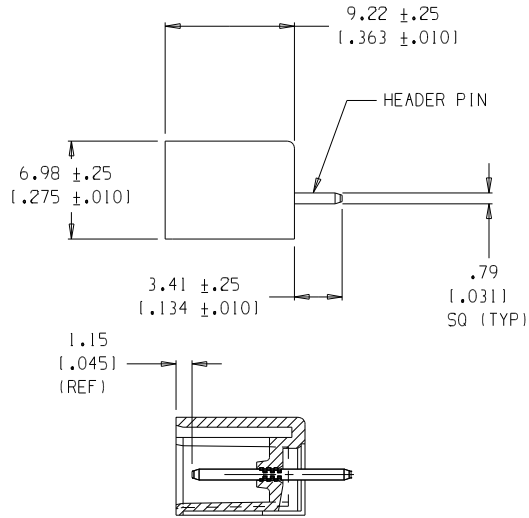
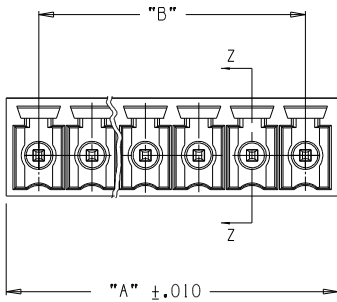
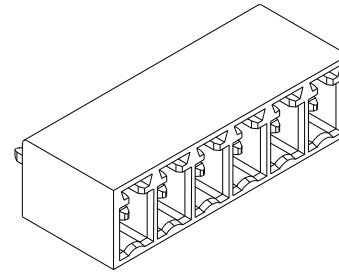
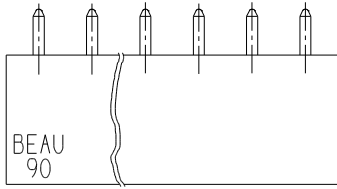

SECT. "Z-Z"

NOTES:

1. MATERIAL: SEE TABLE
2. FINISHES: SEE TABLE
3. PRODUCT SPECIFICATION: NOT REQUIRED
4. PACKAGING: NOT REQUIRED
5. MATES WITH: 90 SERIES PLUG
6. "XX" REFERS TO THE NUMBER OF CIRCUITS.
7. SEE DWG SD-38120-003 FOR PRINTING OPTIONS.

ITEM	QTY.	DESCRIPTION	MATERIAL	FINISH
2	XX	HEADER PIN	BRASS	TIN PLATE
1	1	HEADER	PBT	SEE TABLE

EC NO. 4105 DRWN: GHR 5-2-05 CHK: K APPR: C REV	QUALITY SYMBOLS MAJOR CRITICAL SPC	GENERAL TOLERANCES: (UNLESS SPECIFIED)		SCALE 3:1	DESIGN UNITS <input type="checkbox"/> mm <input checked="" type="checkbox"/> INCH	THIRD ANGLE PROJECTION	PROJECT NO. - DIMENSIONS: <input checked="" type="checkbox"/> mm <input type="checkbox"/> INCH <input type="checkbox"/> mm <input type="checkbox"/> ONLY	SHT REV
		4 PLACES ±.0015 3 PLACES ±.038 ±.005 2 PLACES ±.13 ±.01 1 PLACE ±.3	DRAWN BY & DATE W. HOWARD 10-9-03	TITLE: HEADER, VERTICAL 3.81 (.150)				
		ANGULAR: ±2°	CHECKED BY & DATE L.ROTHAUS 10-9-03	APPROVED BY & DATE L.ROTHAUS 10-9-03				
		DRAFT WHERE APPLICABLE MUST REMAIN WITHIN DIMENSIONS	CAD FILENAME 9016XX	MATERIAL NO. SEE TABLE	DRAWING NO. SD-39900-001	SHEET NO. 1 OF 2		
THIS DRAWING CONTAINS INFORMATION THAT IS PROPRIETARY TO MOLEX INCORPORATED AND SHOULD NOT BE USED WITHOUT WRITTEN PERMISSION.							MOLEX INCORPORATED	SIZE B

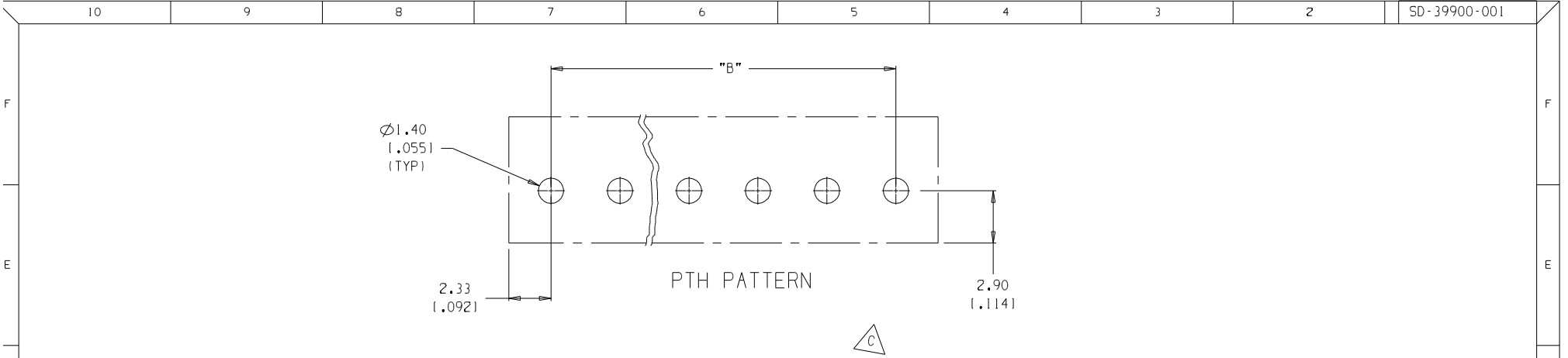

F
E
D
C
B
A

F
E
D
C
B
A

10 9 8 7 6 5 4 3 2 1

NUMBER OF CIRCUITS "XX"	DIM. "A"	DIM. "B"	MATERIAL NO. (G30, BLACK)	MATERIAL NO. (GREEN)	MATERIAL NO. (10AV, BLACK)	MATERIAL NO. (BLACK)
02	8.5 [1.33]	3.81 [1.150]	39901-0502	39900-3502		39900-0502
03	12.3 [1.48]	7.62 [1.300]	39901-0503	39900-3503	39902-0503	39900-0503
04	16.1 [1.63]	11.43 [1.450]	39901-0504	39900-3504		39900-0504
05	19.9 [1.78]	15.24 [1.600]	39901-0505	39900-3505		39900-0505
06	23.7 [1.93]	19.05 [1.750]	39901-0506	39900-3506		39900-0506
07	27.5 [1.08]	22.86 [1.900]	39901-0507	39900-3507		39900-0507
08	31.3 [1.23]	26.67 [1.050]	39901-0508	39900-3508		39900-0508
09	35.1 [1.38]	30.48 [1.200]	39901-0509	39900-3509		39900-0509
10	39.0 [1.53]	34.29 [1.350]	39901-0510	39900-3510		39900-0510
11	42.8 [1.68]	38.10 [1.500]	39901-0511	39900-3511		39900-0511
12	46.6 [1.83]	41.91 [1.650]	39901-0512	39900-3512		39900-0512
13	50.4 [1.98]	45.72 [1.800]	39901-0513	39900-3513		39900-0513
14	54.2 [2.13]	49.53 [1.950]	39901-0514	39900-3514		39900-0514
15	58.0 [2.28]	53.34 [2.100]	39901-0515	39900-3515		39900-0515
16	61.8 [2.43]	57.15 [2.250]	39901-0516	39900-3516	39902-0516	39900-0516
17	65.6 [2.58]	60.96 [2.400]	39901-0517	39900-3517		39900-0517
18	69.4 [2.73]	64.77 [2.550]	39901-0518	39900-3518		39900-0518
19	73.2 [2.88]	68.58 [2.700]	39901-0519	39900-3519		39900-0519
20	77.1 [3.03]	72.39 [2.850]	39901-0520	39900-3520		39900-0520
21	80.9 [3.18]	76.20 [3.000]	39901-0521	39900-3521		39900-0521

EC NO. SEE SHEET 1 DRAWN: CH'K: APPR:	QUALITY SYMBOLS MAJOR CRITICAL SPC	GENERAL TOLERANCES: (UNLESS SPECIFIED)	SCALE 3:1	DESIGN UNITS <input type="checkbox"/> mm <input checked="" type="checkbox"/> INCH	THIRD ANGLE PROJECTION	PROJECT NO. -	-	-
			4 PLACES ±.0015	3 PLACES ±.038 ±.005	2 PLACES ±.13 ±.01	1 PLACE ±.3	ANGULAR: ±2°	DRAFT WHERE APPLICABLE MUST REMAIN WITHIN DIMENSIONS
DESCRIPTION REV			DRAWN BY & DATE W. HOWARD 10-9-03	CHECKED BY & DATE L. ROTHHAUS 10-9-03	APPROVED BY & DATE L. ROTHHAUS 10-9-03	TITLE: HEADER, VERTICAL 3.81 [1.150]		
			CAD FILENAME 9016XX	MATERIAL NO. SEE TABLE	DRAWING NO. SD-39900-001	SHEET NO. 2 OF 2		

A

A