

Features

- Surface Mount Device
- 8 μm I-Region Length Devices
- Two PIN diodes in Flexible Configuration
- No Wire bonds Required
- Rugged Silicon-Glass Construction
- Silicon Nitride Passivation
- Polymer Scratch Protection
- Low Parasitic Capacitance and Inductance

Description

The MADP-000208-13180W is a pair of silicon glass PIN diodes incorporated onto one chip and is fabricated using M/A-COM Technology Solutions patented HMIC™ process. The device features three silicon pedestals embedded in low loss, low dispersion glass ($k=4.1$, $\text{Tan}\delta=0.002$). The diodes are formed on the top of pedestals and connections to the backside of the device are made via electrically conductive sidewalls. Selective backside metallization is applied to produce a surface mount device. This vertical topology provides for exceptional heat transfer and also allows the topside to be fully encapsulated with silicon nitride. An additional polymer layer is also added to provide scratch and impact protection. These protective coatings prevent damage to the junction and the anode air-bridge during handling and assembly.

Applications

The MADP-000208-13180W packageless devices are suitable for usage in high incident power, 44.8 dBm C.W at 2 GHz., series, shunt, or series-shunt switches. The low parasitic inductance, < 0.12 nH, and excellent RC constant, make these devices an attractive alternative for high frequency switch elements when compared to their plastic device counterparts.

Ordering Information

Part Number	Package
MADP-000208-13180W	200 pieces per tray

Outline Drawing

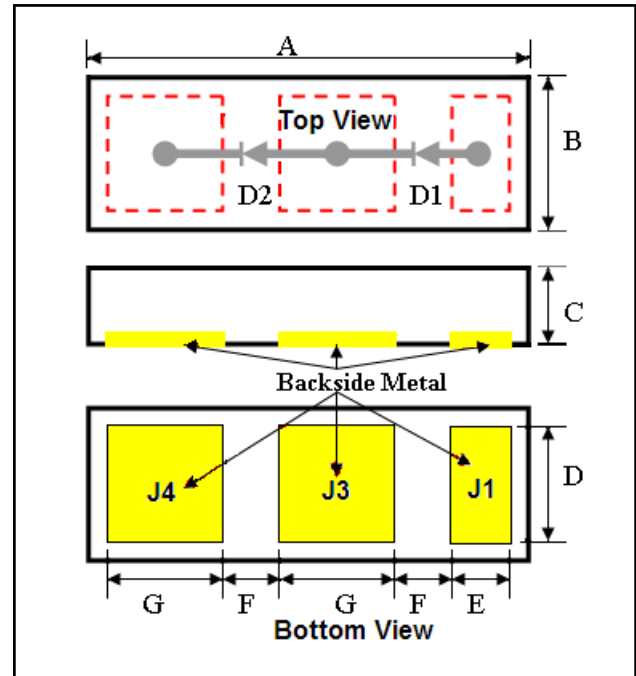

Bottom Side Contacts (Circuit Side)

Dim.	Inches		Millimeter	
	min	max	min	max
A	0.0440	0.0460	1.118	1.168
B	0.0140	0.0160	0.355	0.406
C	0.0045	0.0055	0.114	0.140
D	0.0115	0.0125	0.292	0.318
E	0.0055	0.0065	0.140	0.165
F	0.0055	0.0065	0.140	0.165
G	0.0115	0.0125	0.292	0.318

MADP-000208-13180W

SURMOUNT™ 8μm PIN Diode Pair
RoHS Compliant

M/A-COM Products
Rev. V2

Electrical Specifications^{1,2,3}: T_A = +25°C

D1 - J1 to J3 & D2 - J3 to J4

Parameter	Test Conditions	Units	Min.	Typ.	Max.
Capacitance (C _T) ⁴	-10 V, 1 MHz	pF	—	0.81	0.90
Resistance (R _S)	+10 mA, 1 GHz +100 mA, 1 GHz	Ω	— —	0.40 0.30	0.62 0.52
Forward Voltage (V _F) ⁴	+5 mA +100 mA	V	— —	0.78 1.00	0.90 1.1
Reverse Leakage Current (I _R) ⁴	-90V	μA	—	—	10
C.W. Thermal Resistance (R _{θJL})		°C/W	—	58	—
Lifetime (T _L)	+10 mA / -6 mA (50% - 90% V)	μS	—	0.5	—

1. Total capacitance (C_T), is equivalent to the sum of Junction Capacitance (C_J) and Parasitic Capacitance (C_{PAR})
2. Series resistance (R_S) is equivalent to the total diode resistance: R_S = R_J (Junction Resistance) + R_C (Ohmic Resistance)
3. R_S is measured on an HP4291A Impedance Analyzer with die mounted in an ODS-186 package using Sn60/Pb40 solder.
4. On wafer measurement.

Absolute Maximum Ratings

Parameter	Absolute Maximum
Forward Current	500 mA
Reverse Voltage	- 90 V
Operating Temperature	-55 °C to +125°C
Storage Temperature	-55 °C to +150°C
Junction Temperature	+175°C
C.W. Incident Power	44.8 dBm @ 2 GHz
Mounting Temperature for RoHS Solders	+260 °C for 10 seconds

Application Schematic

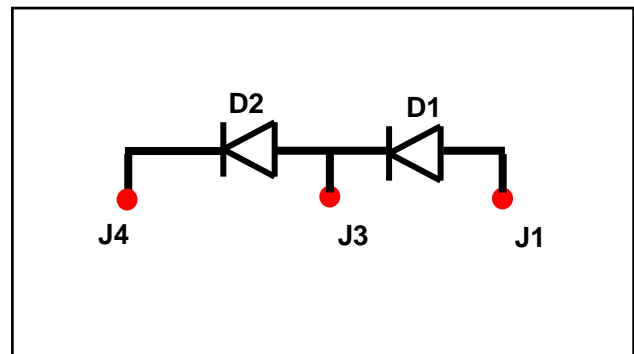

Typical Performance Curves @ 25°C

Resistance vs. Frequency @ 5, 10 & 20 mA

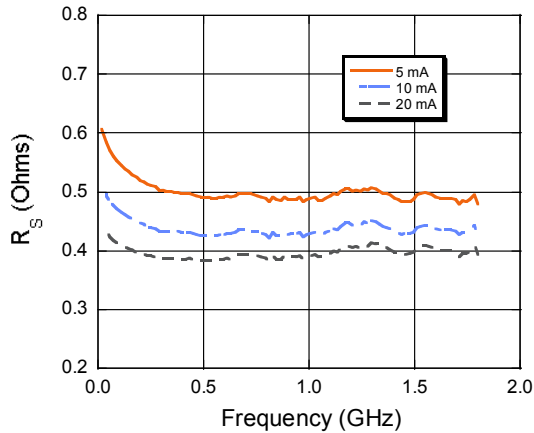

Resistance vs. Forward Current @ 30, 500, 1000 MHz

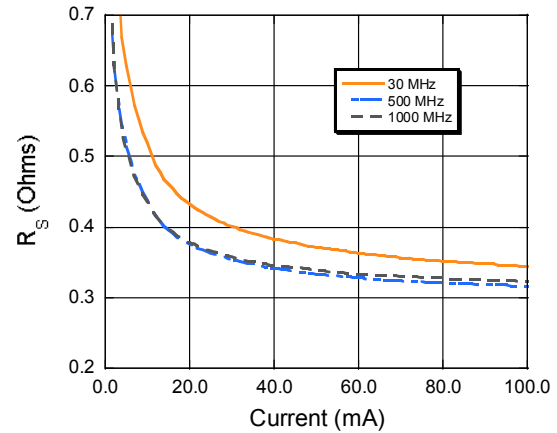

Capacitance vs. Frequency @ 10 & 40 V

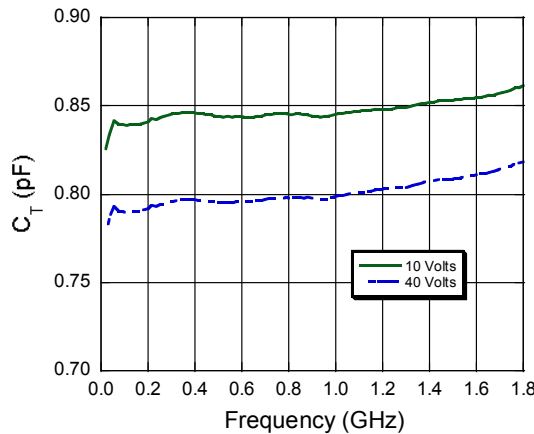

Capacitance vs. Voltage @ 30, 500, 1000 MHz

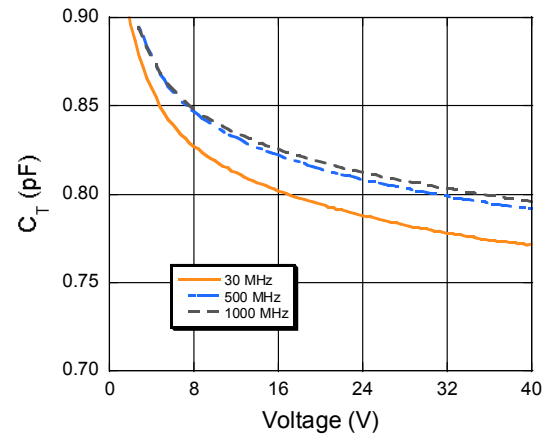

Series Inductance vs. Frequency @ 5, 10 & 20 mA

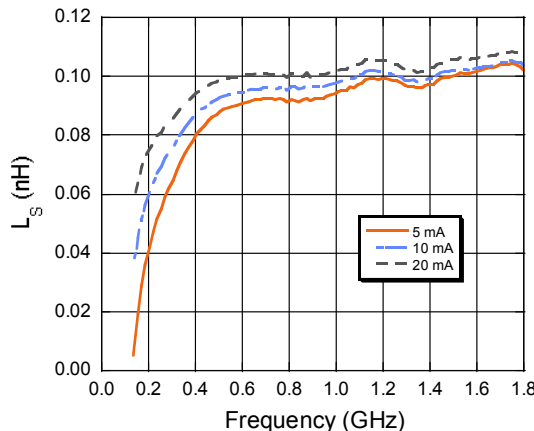

Series Inductance vs. Forward Current @ 500 & 1000 MHz

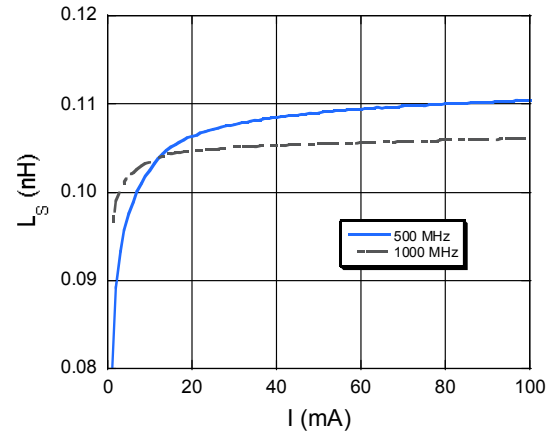

ADVANCED: Data Sheets contain information regarding a product M/A-COM Technology Solutions is considering for development. Performance is based on target specifications, simulated results, and/or prototype measurements. Commitment to develop is not guaranteed.
PRELIMINARY: Data Sheets contain information regarding a product M/A-COM Technology Solutions has under development. Performance is based on engineering tests. Specifications are typical. Mechanical outline has been fixed. Engineering samples and/or test data may be available. Commitment to produce in volume is not guaranteed.

• **North America** Tel: 800.366.2266 • **Europe** Tel: +353.21.244.6400
 • **India** Tel: +91.80.43537383 • **China** Tel: +86.21.2407.1588
 Visit www.macontech.com for additional data sheets and product information.

M/A-COM Technology Solutions Inc. and its affiliates reserve the right to make changes to the product(s) or information contained herein without notice.

Die Handling and Mounting Information

Handling: All semiconductor chips should be handled with care to avoid damage or contamination from perspiration, salts, and skin oils. The use of plastic tipped tweezers or vacuum pickups is strongly recommended for individual components. Bulk handling should ensure that abrasion and mechanical shock are minimized.

Electro-Static Sensitivity: The MADP-000208-13108W Diode Pair are ESD, Class 1A sensitive (HBM). Proper ESD precautions should be taken.

Die Attach Surface: Die can be mounted with an 80Au/Sn20, eutectic solder preform, RoHS compliant solders or electrically conductive silver epoxy. The metal RF and D.C. ground plane mounting surface must be free of contamination and should have a surface flatness of $< \pm 0.002''$.

Eutectic Die Attachment Using Hot Gas Die Bonder: A work surface temperature of 255°C is recommended. When hot forming gas is applied, the temperature should be approximately 290°C. The chip should not be exposed to temperatures greater than 320°C for more than 10 seconds.

Eutectic Die Attachment Using Reflow Oven: Please visit the www.macomtech.com and see [Application Note M538](#), "Surface Mounting Instructions" for the recommended time-temperature profile.

Electrically Conductive Epoxy Die Attachment: A controlled amount of electrically conductive, silver epoxy, approximately 1–2 mils in thickness, should be used to minimize ohmic and thermal resistance. A thin epoxy fillet should be visible around the perimeter of the bond pad after placement to ensure full area coverage. Cure conductive epoxy per manufacturer's schedule. Typically 150°C for 1 hour.