

Specification

- Part No. : **SGGP.25.4.A.02**
- Description : GPS/GLONASS/GALILEO SMT Patch Antenna
- Features : 25mm*25mm*4mm
Single Feed SMT Mount GPS/GALILEO: 1575MHz
GLONASS: 1602MHz
Patent pending
RoHS Compliant



1. Introduction

This ceramic 25*25*4mm GPS/GLONASS/GALILEO patch antenna is mounted via SMT process and has been pre-tuned for a 50*50mm ground plane. Custom part no's tuned for different ground-plane or layout positions and taking into account the specific conditions in your device can be created and supplied by Taoglas.

2. Specification

Patch Specification tested on 50*50mm ground plane

Parameter	Specification
Operating Bands	GPS/GALILEO: 1575.42 MHz \pm 1.023 MHz GLONASS: 1602 \pm 5 MHz
VSWR	<2.5
Return Loss in Band	<-10 dB
Efficiency	GPS/GALILEO (1575.42 MHz): 83% GLONASS (1602 MHz): 84%
Polarization	RHCP
Impedance	50 Ω
Frequency Temperature Coefficient (-40°C to +85°C)	0 \pm 20ppm / °C
Operating Temperature	-40°C to +85°C

**Changes in user groundplane and environment will offset centre frequenc

3. Electrical Specifications

3.1. Return Loss

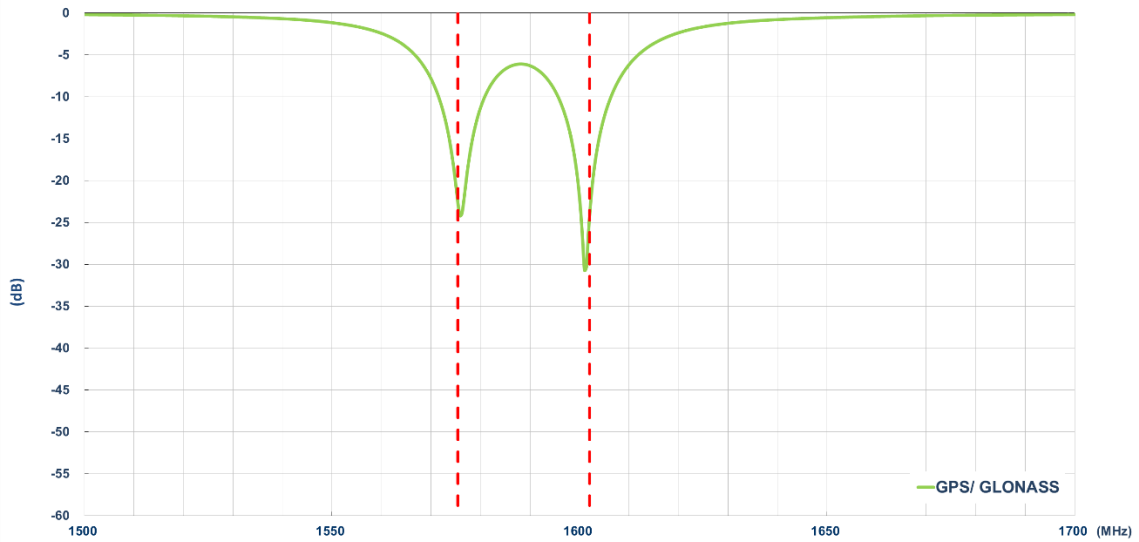

3.2. Efficiency

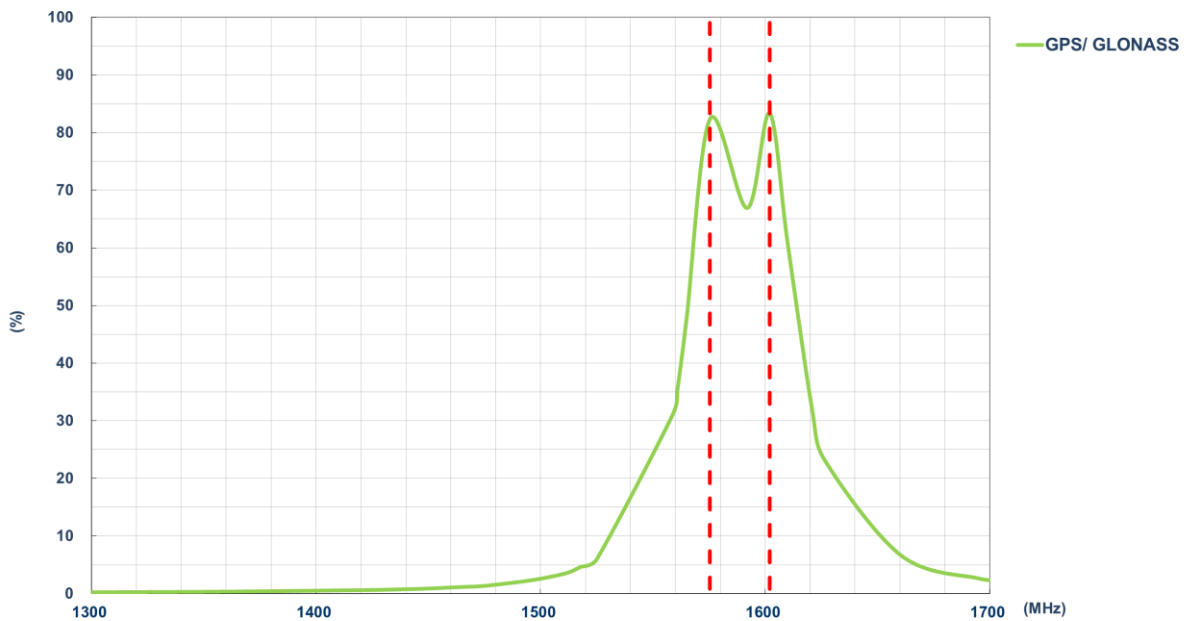

3.3. Average Gain

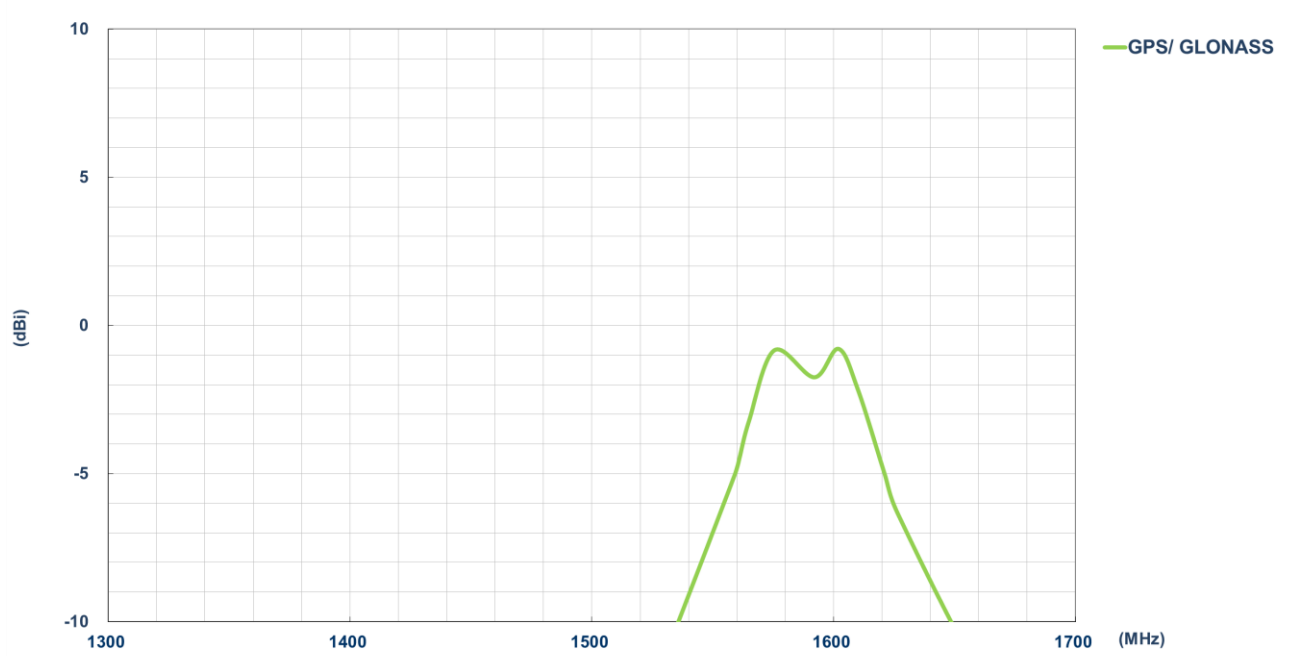

3.4. Peak Gain

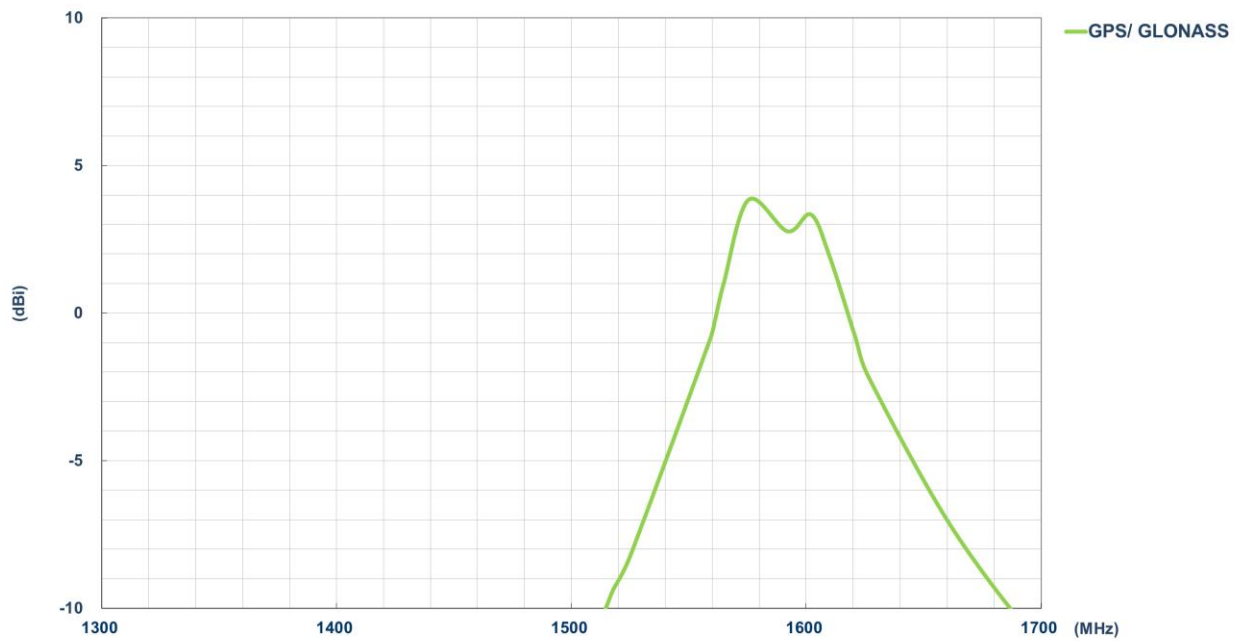

4. Radiation Patterns

4.1. Chamber Test Setup

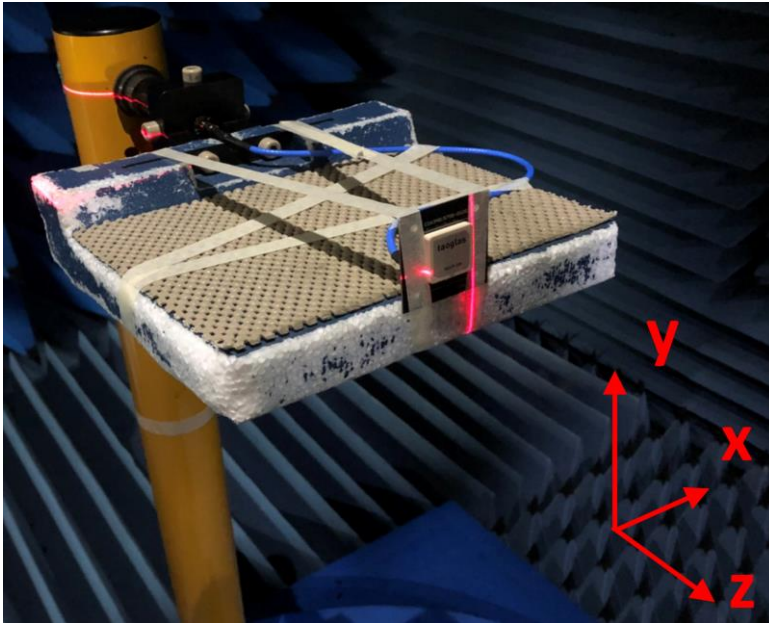

4.2. 2D Radiation Patterns

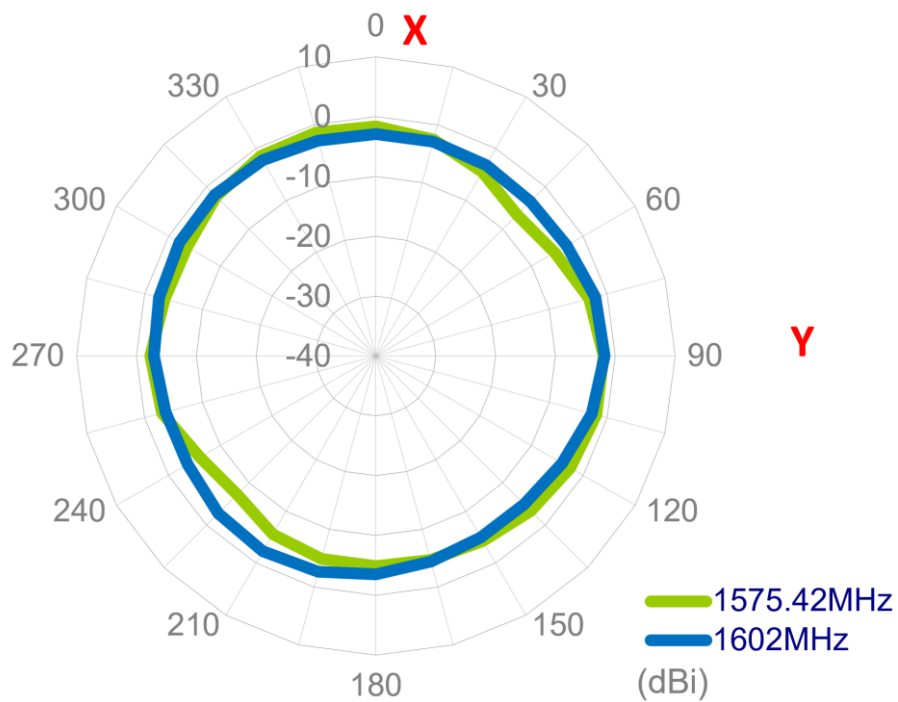

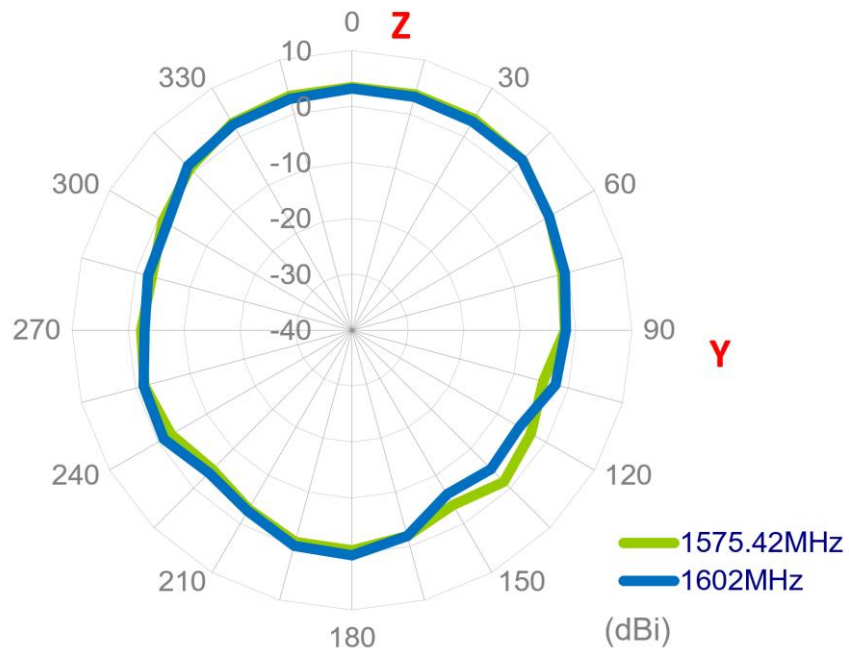
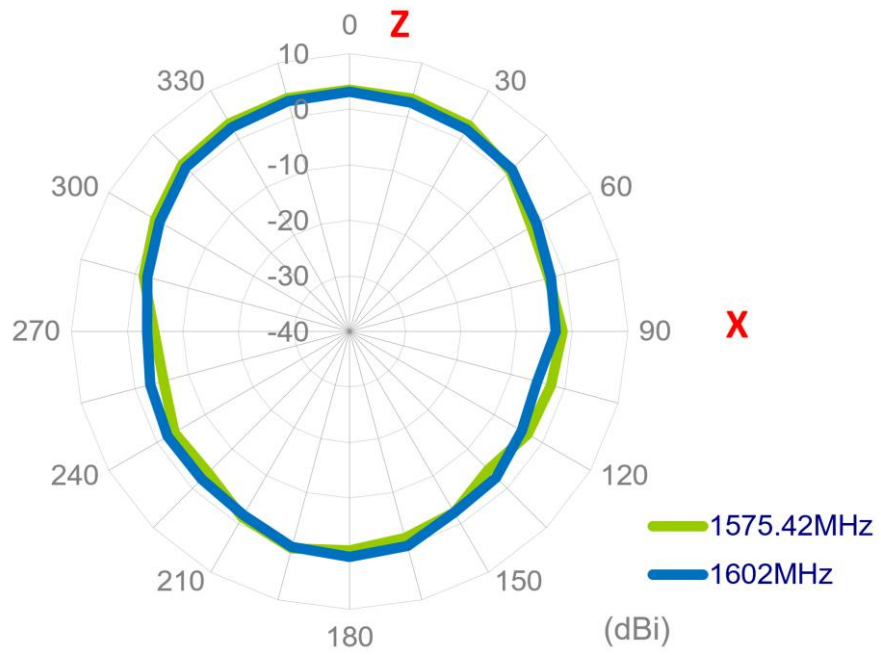

4.2. 3D Radiation Patterns

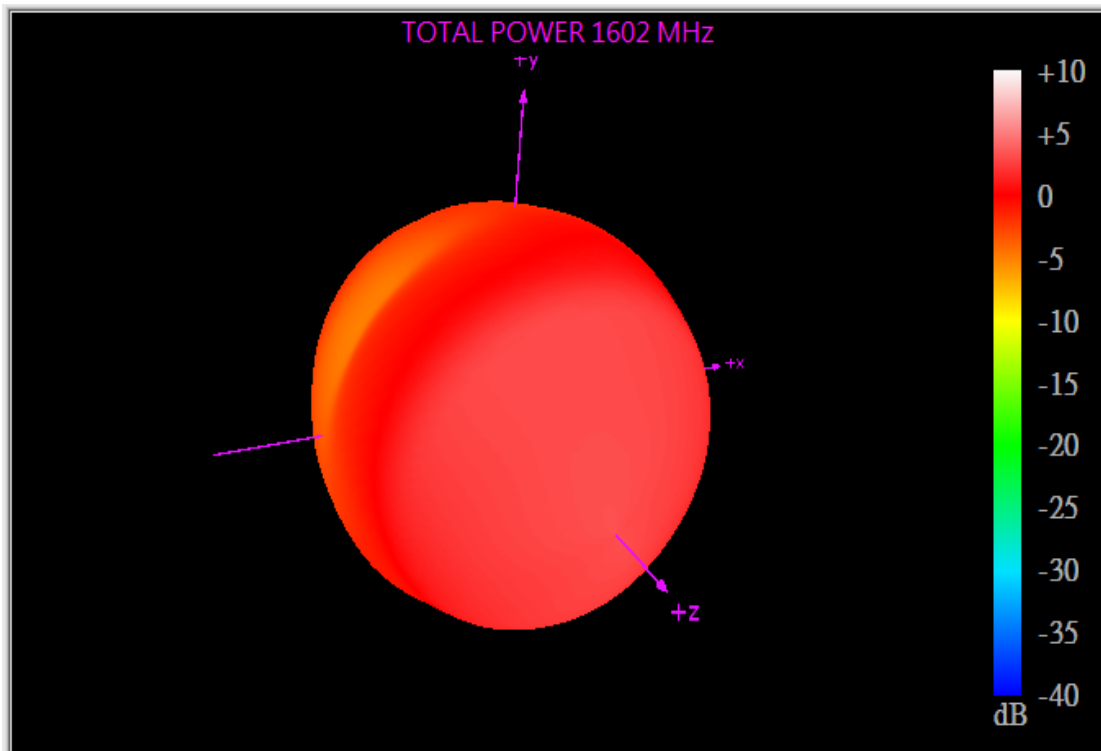
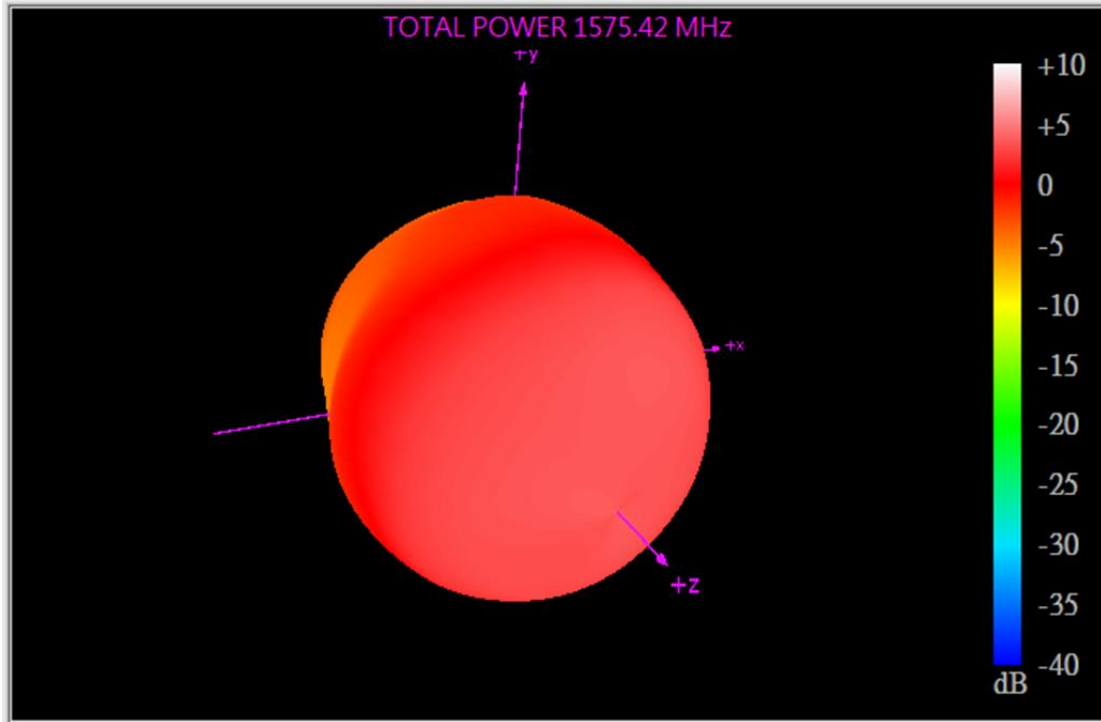

5. Mechanical Specifications



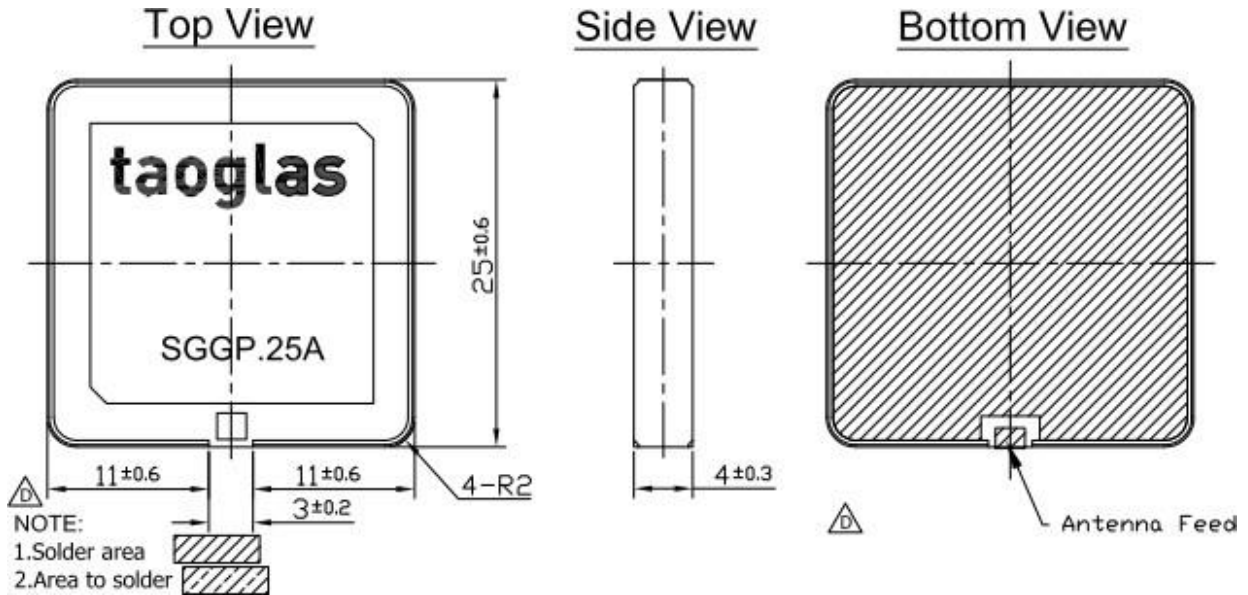

5.1. Antenna Dimensions and Drawing (Unit: mm)

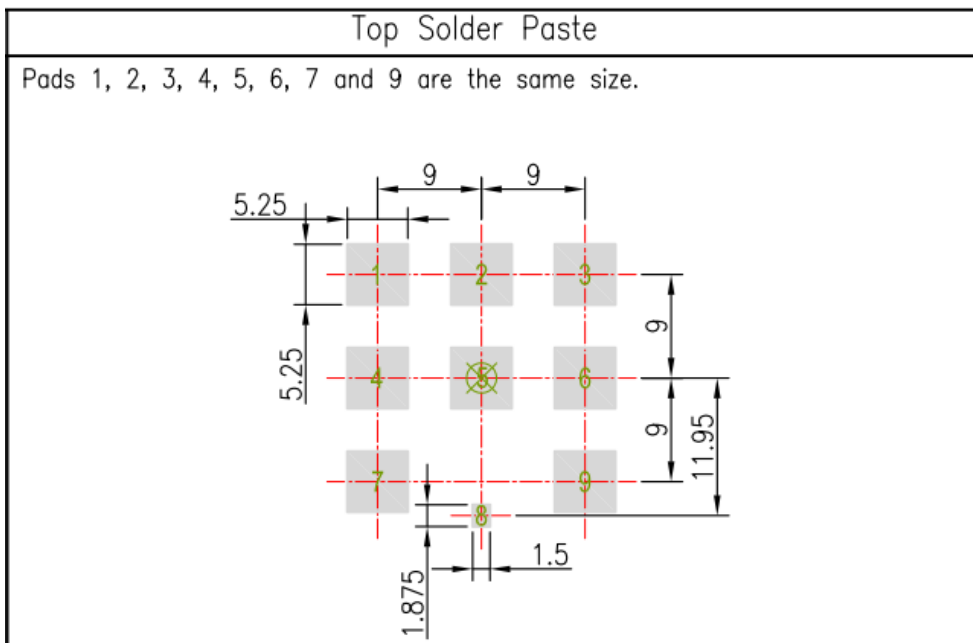
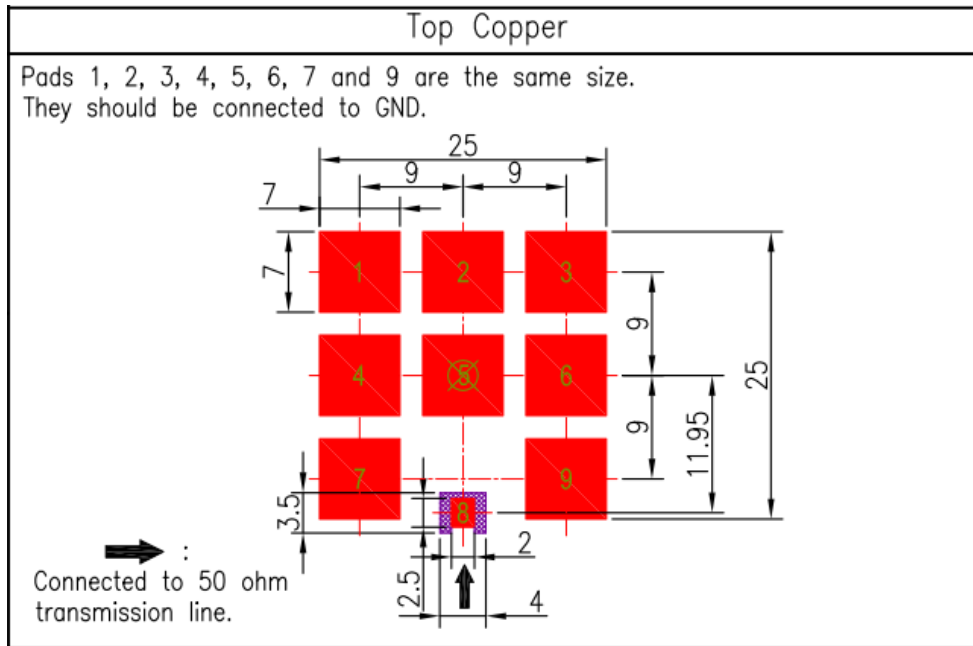

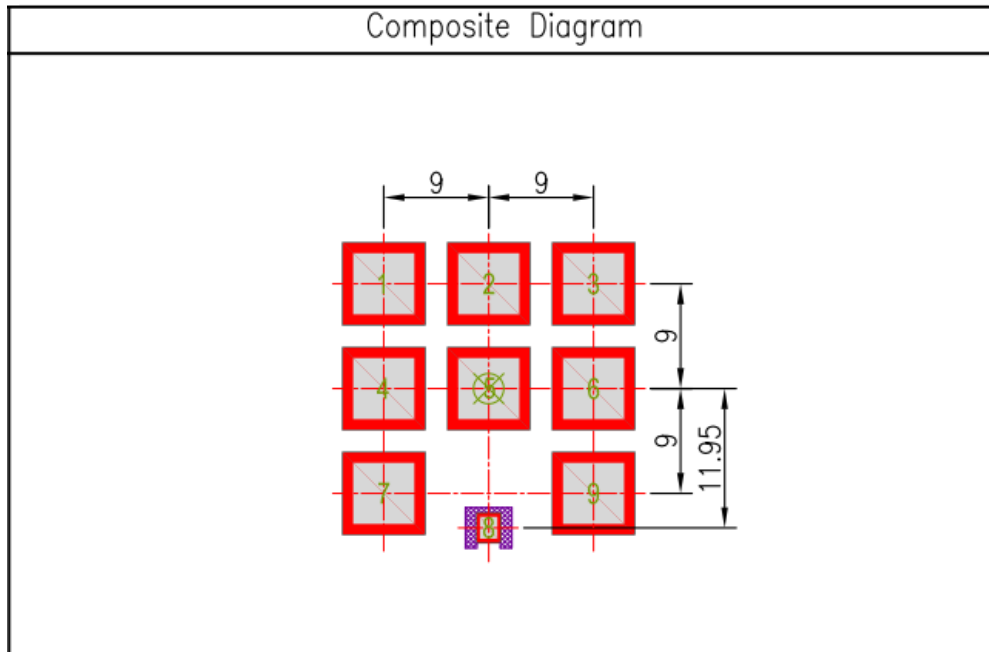
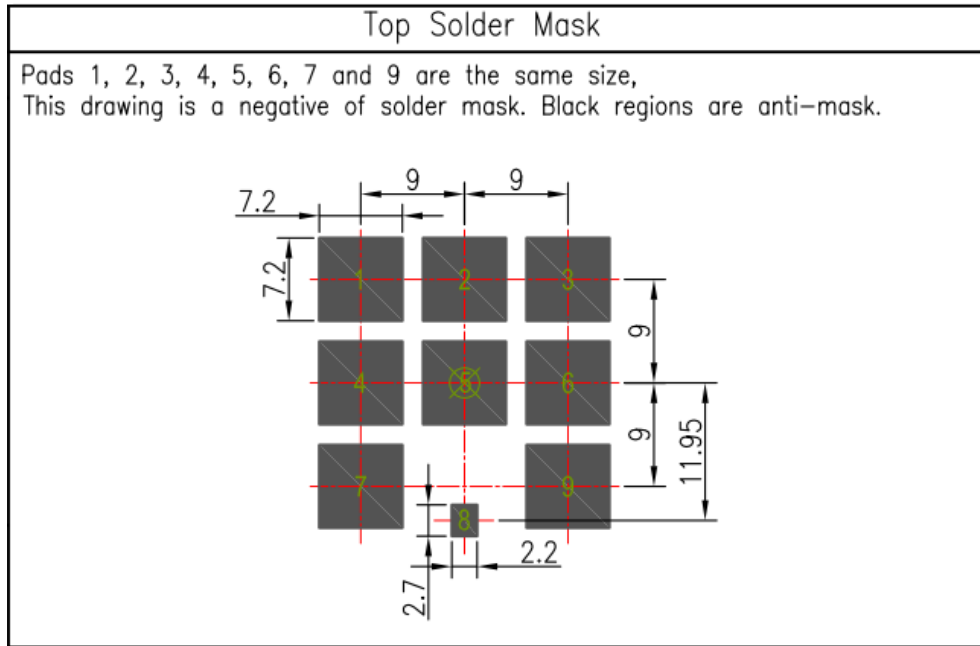
5.2. PCB Footprint Recommendation (Unit: mm)





NOTE:		
1. Ag Plated area		6. Copper keepout should extend through all PCB layers.
2. Solder Mask area		7. Any vias in pads should be either filled or tented to prevent solder from wicking away from the pad during reflow.
3. Copper area		8. The dimension tolerances should follow standard PCB manufacturing guidelines
4. Paste area		
5. Copper Keepout Area		

5.3. Test Jig and Dimension SGGPD.25A

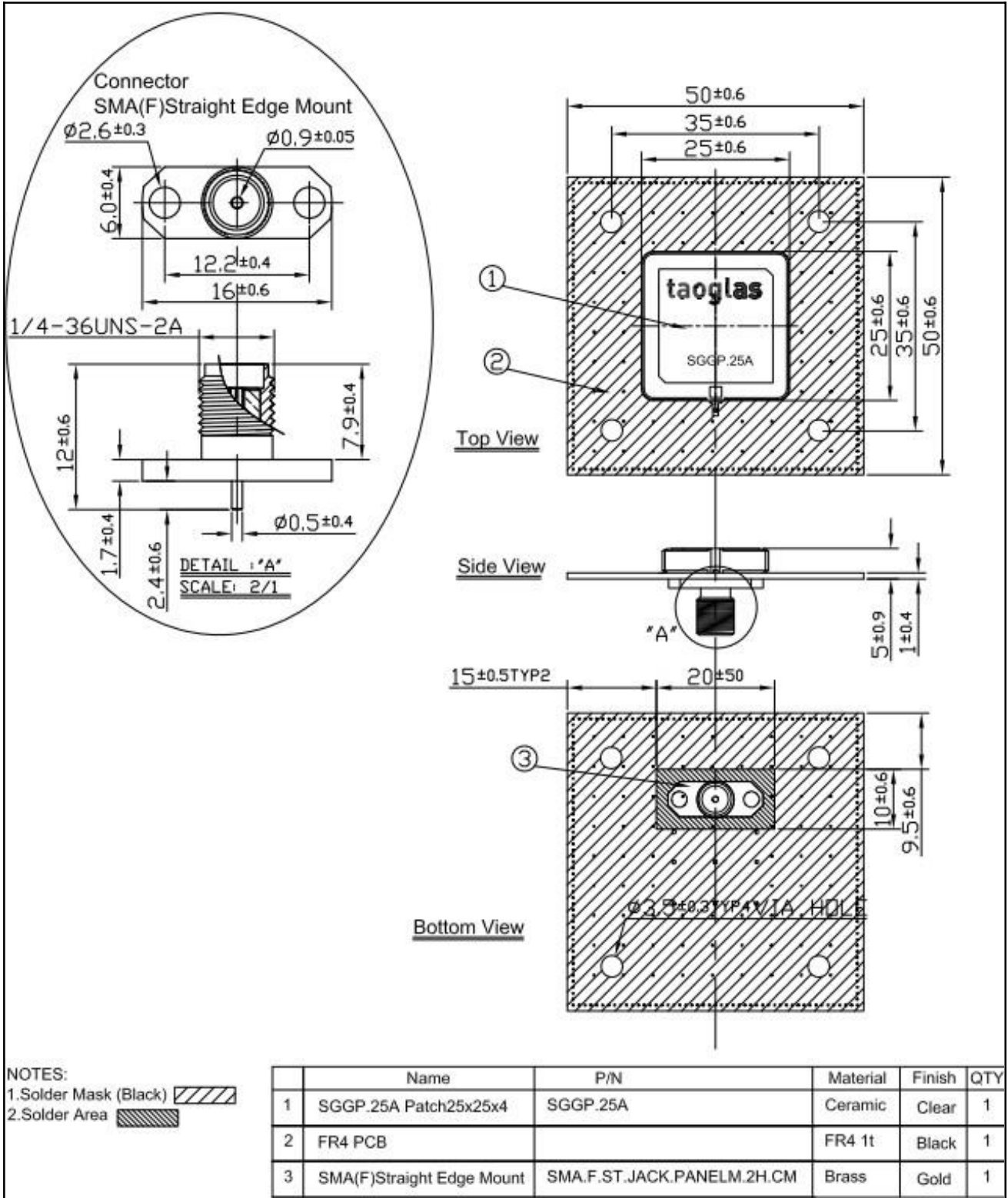

5.4. SGGP.25A On Evaluation Board

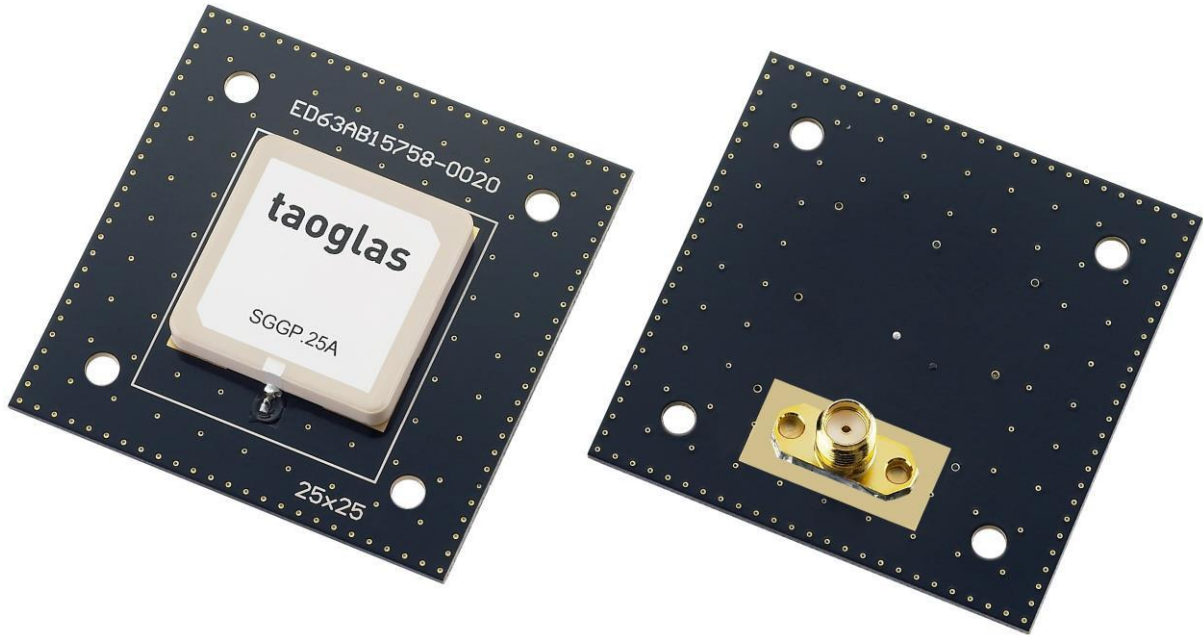

6. Recommended Reflow Soldering Profile

SGGP.25A can be assembled following Pb-free assembly. According to the Standard IPC/JEDEC J-STD-020C, the temperature profile suggested is as follow:

Phase	Profile Features	Pb-Free Assembly (SnAgCu)
PREHEAT	Temperature Min(T_{smin})	150°C
	Temperature Max(T_{smax})	200°C
	Time(t_s) from (T_{smin} to T_{smax})	60-120 seconds
RAMP-UP	Avg. Ramp-up Rate (T_{smax} to T_P)	3°C/second(max)
REFLOW	Temperature(T_L)	217°C
	Total Time above T_L (t_L)	30-100 seconds
PEAK	Temperature(T_P)	260°C
	Time(t_p)	2-5 seconds
RAMP-DOWN	Rate	3°C/second(max)
Time from 25°C to Peak Temperature		8 minutes max.
Composition of solder paste		96.5Sn/3Ag/0.5Cu
Solder Paste Model		SHENMAO PF606-P26

The graphic shows temperature profile for component assembly process in reflow ovens

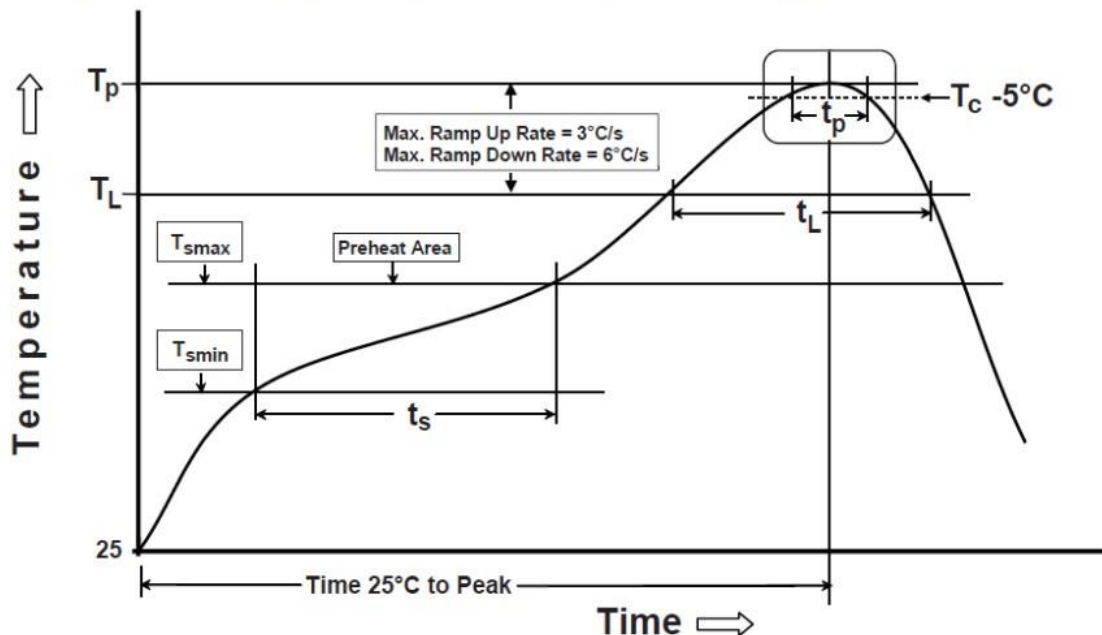

Soldering Iron condition: Soldering iron temperature $270^{\circ}\text{C} \pm 10^{\circ}\text{C}$.

Apply preheating at 120°C for 2-3 minutes. Finish soldering for each terminal within 3 seconds, if soldering iron temperature over $270^{\circ}\text{C} \pm 10^{\circ}\text{C}$ or 3 seconds, it will make cause component surface peeling or damage.

7. Packaging

200 pcs / reel / inner carton
4 reels in an outer carton (800)

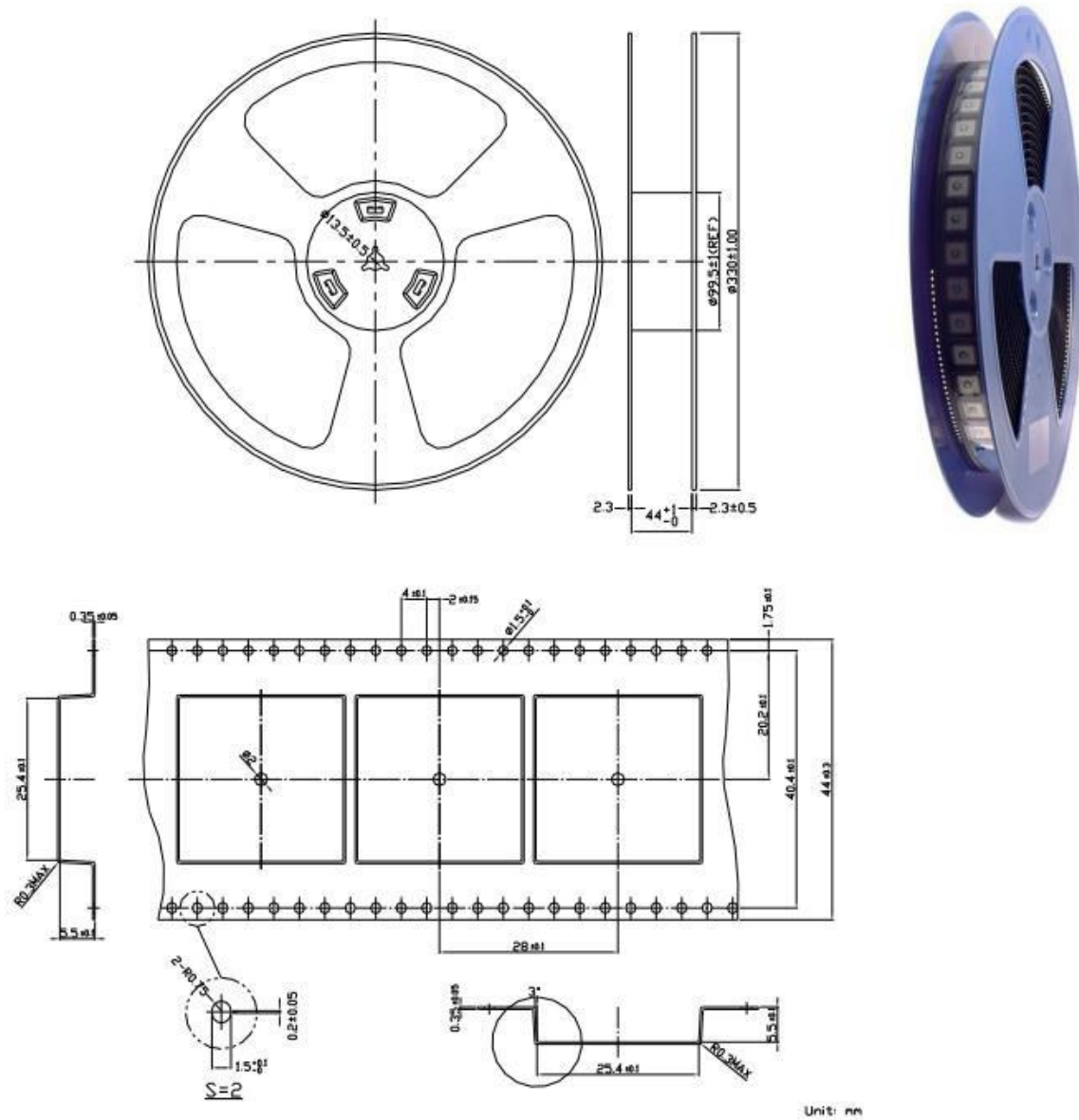

Taoglas makes no warranties based on the accuracy or completeness of the contents of this document and reserves the right to make changes to specifications and product descriptions at any time without notice. Taoglas reserves all rights to this document and the information contained herein.

Reproduction, use or disclosure to third parties without express permission is strictly prohibited.

Copyright © Taoglas Ltd.