

PLEASE CHECK WWW.MOLEX.COM FOR LATEST PART INFORMATION

Part Number: [0930034220](#)
Status: **Active**
Overview: [rast 5 connector system](#)
Description: 5.00mm (.197") Pitch Appli-Mate RAST 5 Header, Right Angle, 7 Circuits, Reference K01 Silver (Ag), Glow Wire Compatible

Documents:

[Drawing \(PDF\)](#) [RoHS Certificate of Compliance \(PDF\)](#)

General

Product Family	PCB Headers
Series	93003
Application	Wire-to-Board
Overview	rast 5 connector system
Product Name	RAST 5

Physical

Breakaway	No
Circuits (Loaded)	7
Circuits (maximum)	7
Color - Resin	Natural
Durability (mating cycles max)	10
First Mate / Last Break	No
Glow-Wire Compliant	Yes
Guide to Mating Part	No
Keying to Mating Part	Yes
Lock to Mating Part	No
Material - Metal	Brass
Material - Plating Mating	Silver
Material - Resin	Nylon
Number of Rows	1
Orientation	Right Angle
PC Tail Length (in)	0.138 In
PC Tail Length (mm)	3.50 mm
PCB Locator	Yes
PCB Retention	None
PCB Thickness Recommended (in)	0.055 In
PCB Thickness Recommended (mm)	1.40 mm
Packaging Type	Bag
Pitch - Mating Interface (in)	0.197 In
Pitch - Mating Interface (mm)	5.00 mm
Plating min: Mating (µin)	80
Plating min: Mating (µm)	2
Polarized to PCB	Yes
Robotic Placement	None
Shrouded	Fully
Stackable	Yes
Surface Mount Compatible (SMC)	No
Temperature Range - Operating	-20°C to +85°C
Termination Interface: Style	Through Hole

Electrical

Current - Maximum per Contact	16A
Voltage - Maximum	250V AC

Material Info

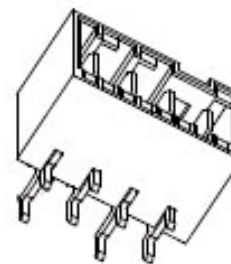

image - Reference only

Series

EU RoHS

**ELV and RoHS
Compliant**
**REACH SVHC
Not Reviewed**
**Halogen-Free
Status
Not Reviewed**

China RoHS



**Need more information on product
environmental compliance?**

Email productcompliance@molex.com
 For a multiple part number RoHS Certificate of Compliance, [click here](#)

Please visit the [Contact Us](#) section for any non-product compliance questions.

Search Parts in this Series
[93003Series](#)

Reference - Drawing Numbers

Packaging Specification
Sales Drawing

PK-90858-001
SD-93003-001

This document was generated on 05/26/2010

PLEASE CHECK WWW.MOLEX.COM FOR LATEST PART INFORMATION

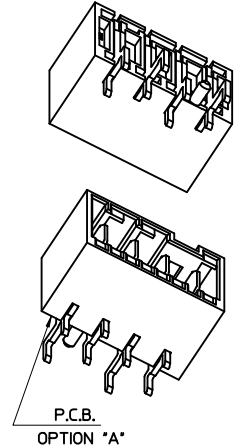
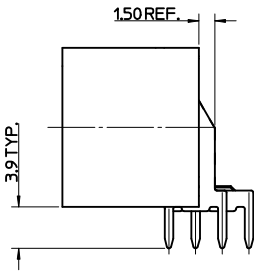
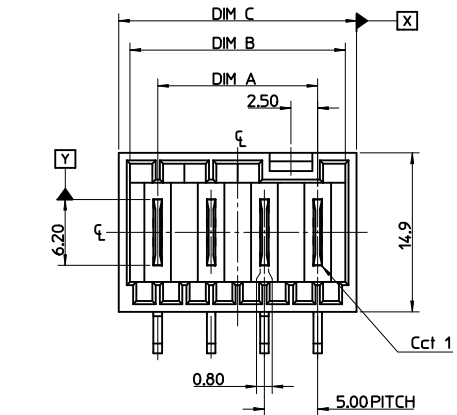
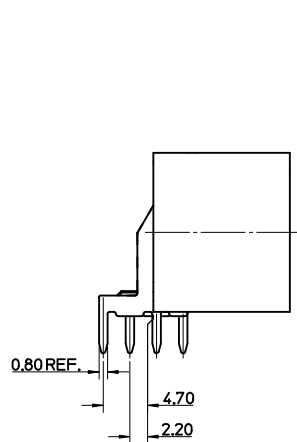

HOLES ON SOME TOOLED VERSIONS

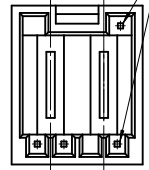

CCT	DIM A	DIM B	DIM C	TOL
2	5.00	10.20	12.30	+/-0.30
3	10.00	15.20	17.30	
4	15.00	20.20	22.30	
5	20.00	25.20	27.30	
6	25.00	30.20	32.30	
7	30.00	35.20	37.30	
8	35.00	40.20	42.30	
9	40.00	45.20	47.30	
10	45.00	50.20	52.30	
11	50.00	55.20	57.30	
12	55.00	60.20	62.30	

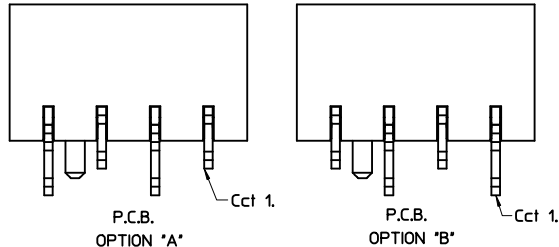
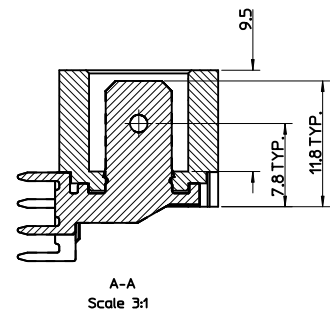
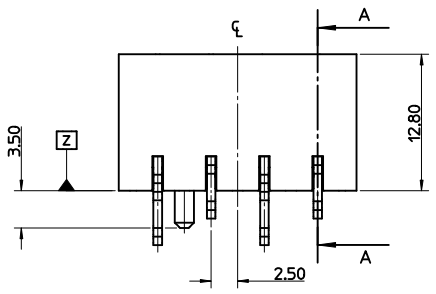

RECOMMENDED PCB LAYOUT

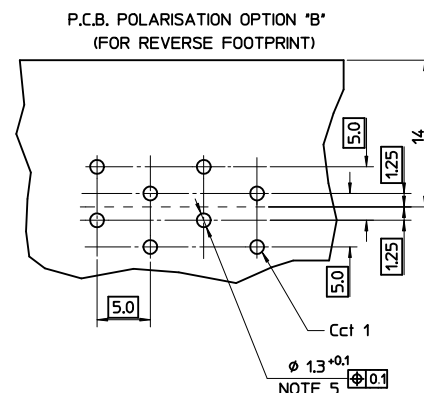
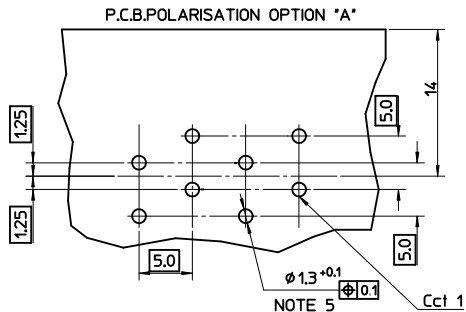

- NOTES:
- MATERIAL:
HOUSING: PA 66, UL94 V-0 750°C GWT NO FLAME
TERMINAL: BRASS 0.80 REF. THICK
PLATING: OPTIONAL (SEE CHARTS SHEETS 2-7)
5µm TIN OVER
2.5µm NICKEL ALLOVER
SELECTIVE SILVER
2µm SILVER OVER
3-5µm TIN OVER
2.5µm NICKEL ALLOVER

- PRODUCT CONFORMS TO SPECIFICATION PS-99020-0037/39
- MATES WITH MOLEX 91338, 90833, 90835, 91777, 91778, 91954, 92000 & 91779
- PARTS PACKAGED LOOSE IN PLASTIC BAGS
- PLATED THRU HOLE
- RECOMMENDED PCB THICKNESS: 1.4±0.1mm.
- PCB VIEW IS FROM SOLDER SIDE

REV	DESCRIPTION	QUALITY SYMBOLS	GENERAL TOLERANCES (UNLESS SPECIFIED)		DIMENSION STYLE		SCALE	DESIGN UNITS	THIRD ANGLE PROJECTION
			mm	INCH	MM ONLY	TITLE			
MOULD TOOLING CHANGE	EC NO: E2010-0370	▽=0	4 PLACES ±---	±---	DRAWN BY	DATE	1:1	METRIC	RAST 5 R.A. HDR PA 66 HOUSING
	DRWN:BRUTTLE 2010/05/17	▽=0	3 PLACES ±---	±---	B. RUTTLE	2006/10/10			
	CHKD:T. TOURISH 2006/10/10		2 PLACES ±0.1	±---	CHECKED BY	DATE			
	APPR:BMAGUIRE 2010/06/08		1 PLACE ±0.2	±---	T. TOURISH	2006/10/10			
			ANGULAR ± 2°		APPROVED BY	DATE			
			DRAFT WHERE APPLICABLE MUST REMAIN WITHIN DIMENSIONS		BMAGUIRE	2010/05/28			
			SEE SHEETS 2 TO 7		MATERIAL NO.	DOCUMENT NO.			
			THIS DRAWING CONTAINS INFORMATION THAT IS PROPRIETARY TO MOLEX INCORPORATED AND SHOULD NOT BE USED WITHOUT WRITTEN PERMISSION		MOLEX MOLEX INCORPORATED				
					SD-93003-001				
					SHEET NO. 1 OF 5				

2 CIRCUIT		SEE CODE DESIGNATION TABLE FOR NUMBERING FORMAT WHEN ADDING NEW PART NUMBERS						P.C.B. POLARISATION OPTION.
PART NO. (TIN)	TERMINAL VOID POSITION	UNBLOCKED POSITION KEYS	UNBLOCKED CODING KEYS	LATCH POSITION	CONFIGURATION (SEE NOTES)	REF	PART NO. (SILVER)	
93003-0003	NONE	1b 2a	01c d20	1/2		K01	93003-0499	A
93003-0046	NONE	1a 2b	01c	1/2		K02	93003-0498	A
93003-0026	NONE	1b 2b	01c	1/2		K09	93003-0488	A
93003-0018	NONE	2a	01c, d20	1/2		K03	93003-0495	A
93003-0021	NONE	1b	01c, d20	1/2		K16	93003-0492	A
93003-0022	NONE	1a 2b	NONE	1/2		K06	93003-0491	A
93003-0019	NONE	1a 2b	d20	1/2		K05	93003-0478	A
93003-0058	NONE	2b	NONE	1/2		K11	93003-0476	A
93003-0029	NONE	1a 1b	d20	1/2		K13	93003-0486	A
93003-0030	NONE	2a 2b	NONE	1/2		K31	93003-0485	A
93003-0059	NONE	2b	d20	1/2		K38	93003-0475	A
93003-0060	NONE	1a 2a	01c d20	1/2		K44	93003-0474	A
93003-0061	NONE	1a 1b	NONE	1/2		K40	93003-0473	A
93003-0020	NONE	1a 1b	01c	1/2		K04	93003-0493	A
93003-0062	NONE	2b	01c d20	1/2		K15	93003-0472	A
93003-0057	NONE	1a	01c d20	1/2		K12	93003-0477	A
93003-0009	NONE	1a 2a	01c	1/2		K10	93003-0496	A
93003-0049	NONE	ALL	d20	1/2		K34	93003-0481	A
93003-0056	NONE	1b 2a 2b	d20	1/2		K07	93003-0479	A
93003-0063	NONE	1b 2a	01c d20	1/2		K01	93003-0471	B
93003-0064	NONE	ALL	ALL	1/2		K00	93003-0470	A

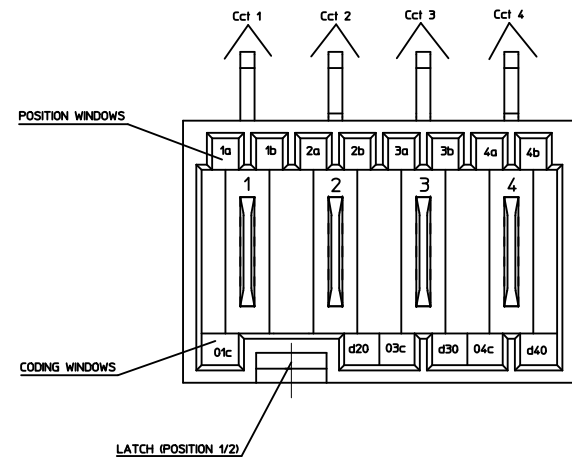

KEYING, CODING & LATCH POSITION
(4CCT EXAMPLE SHOWN)
VIEW INMATING DIRECTION

SEE SHEET 1	QUALITY SYMBOLS	GENERAL TOLERANCES (UNLESS SPECIFIED)	SCALE 1:1	DESIGN UNITS METRIC	THIRD ANGLE PROJECTION	REVISE ON CAD ONLY	
		mm INCH	DIMENSION STYLE MM ONLY		TITLE RAST 5 R.A. HDR PA 66 HOUSING		
		4 PLACES ± --- ± ---	DRAWN BY B.RUTTLE	DATE 2006/10/10	MATERIAL NO. SEE CHART		DOCUMENT NO. SD-93003-001
		3 PLACES ± --- ± ---	CHECKED BY T.TOURISH	DATE 2006/10/10	SHEET NO. 2 OF 5		
	2 PLACES ± 0.1 ± ---	DRAFT WHERE APPLICABLE MUST REMAIN WITHIN DIMENSIONS		THIS DRAWING CONTAINS INFORMATION THAT IS PROPRIETARY TO MOLEX INCORPORATED AND SHOULD NOT BE USED WITHOUT WRITTEN PERMISSION			
	1 PLACE ± 0.2 ± ---	ANGULAR ± 2 °					

3 CIRCUIT							SEE CODE DESIGNATION TABLE FOR NUMBERING FORMAT WHEN ADDING NEW PART NUMBERS		P.C.B. POLARISATION OPTION
PART NO. (TIN)	TERMINAL VOID POSITION	UNBLOCKED POSITION KEYS	UNBLOCKED CODING KEYS	LATCH POSITION	CONFIGURATION (SEE NOTES)	REF	PART NO. (SILVER)		
93003-0502	NONE	1b	01c, d20	1/2		K01	93003-1249	A	
93003-0508	NONE	1a	03c	1/2		K04	93003-1248	A	
93003-0528	NONE	1a 1b	d30	1/2		K05	93003-1247	A	
93003-0512	NONE	1a 3b	01c	1/2		K06	93003-1246	A	
93003-0513	NONE	1b	d20 03c	1/2		K09	93003-1245	A	
93003-0529	NONE	1b 2a 2b	d30	1/2		K33	93003-1244	A	
93003-0530	NONE	2b	d20	1/2		K56	93003-1243	A	
93003-0526	NONE	ALL	d10 d30	2/3		K38	93003-1242	A	
93003-0527	NONE	ALL	d20	1/2		K40	93003-1241	A	
93003-0531	NONE	ALL	ALL	1/2		K00	93003-1240	A	

4 CIRCUIT							SEE CODE DESIGNATION TABLE FOR NUMBERING FORMAT WHEN ADDING NEW PART NUMBERS		P.C.B. POLARISATION OPTION
PART NO. (TIN)	TERMINAL VOID POSITION	UNBLOCKED POSITION KEYS	UNBLOCKED CODING KEYS	LATCH POSITION	CONFIGURATION (SEE NOTES)	REF	PART NO. (SILVER)		
93003-1254	NONE	1b	03c d40	1/2 3/4		K01	93003-1999	A	
93003-1264	NONE	1a 4b	d40	1/2 3/4		K03	93003-1997	A	
93003-1265	NONE	2a 4b	d20	1/2 3/4		K07	93003-1996	A	
93003-1267	NONE	1b 2a 3a 4b	01c d40	1/2 3/4		K37	93003-1994	A	
93003-1278	NONE	1a 2b 4b	01c 03c d40	1/2 3/4		K44	93003-1988	A	
93003-1279	NONE	1a 3a 3b	01c d20 d40	1/2 3/4		K32	93003-1987	A	
93003-1280	NONE	1b 2a 4b	01c d20 03c	1/2 3/4		K61	93003-1986	A	
93003-1281	NONE	1a 3a	d40	1/2 3/4		K06	93003-1985	A	
93003-1282	NONE	1a 2b 3b 4a	01c 03c d40	1/2 3/4		K65	93003-1984	A	
93003-1266	NONE	2a 4b	d20 03c	1/2 3/4		K30	93003-1995	A	
93003-1276	NONE	3b	d30	2/3		K04	93003-1989	A	
93003-1283	NONE	ALL	ALL	1/2 3/4		K00	93003-1983	A	
93003-1284	NONE	1b	03c	1/2 3/4		N/A	93003-1982	A	

SEE SHEET 1 EC NO. DRW:BRUTTLE 2010/05/17 CHKD: T.TOURISH 2006/10/10 APPR: BMAGUIRE 2010/06/08 REV DESCRIPTION	QUALITY SYMBOLS	GENERAL TOLERANCES (UNLESS SPECIFIED)	SCALE 1:1	DESIGN UNITS METRIC	THIRD ANGLE PROJECTION	REVISE ON CAD ONLY
	 	mm INCH	DIMENSION STYLE MM ONLY	TITLE RAST 5 R.A. HDR PA 66 HOUSING		
		4 PLACES ± --- ± --- 3 PLACES ± --- ± --- 2 PLACES ± 0.1 ± --- 1 PLACE ± 0.2 ± ---	DRAWN BY DATE BRUTTLE 2006/10/10 CHECKED BY DATE T.TOURISH 2006/10/10 APPROVED BY DATE BMAGUIRE 2010/05/28	MATERIAL NO. SHEET NO. SEE CHART SD-93003-001 3 OF 5		
	ANGULAR ± 2 ° DRAFT WHERE APPLICABLE MUST REMAIN WITHIN DIMENSIONS		THIS DRAWING CONTAINS INFORMATION THAT IS PROPRIETARY TO MOLEX INCORPORATED AND SHOULD NOT BE USED WITHOUT WRITTEN PERMISSION			

5 CIRCUIT		SEE CODE DESIGNATION TABLE FOR NUMBERING FORMAT WHEN ADDING NEW PART NUMBERS						P.C.B. POLARISATION OPTION
PART NO. (TIN)	TERMINAL VOID POSITION	UNBLOCKED POSITION KEYS	UNBLOCKED CODING KEYS	LATCH POSITION	CONFIGURATION (SEE NOTES)	REF	PART NO. (SILVER)	
93003-2000	NONE	1a 5b	01c d30	1/2 2/3		K01	93003-2749	A
93003-2001	NONE	1a 3a	01c d30	1/2 4/5		K30	93003-2748	A
93003-2002	NONE	1a 5b	01c d20 03c d50	1/2 3/4		K31	93003-2747	A
93003-2003	NONE	1b 2a 3b 5a	01c 03c	1/2 3/4		K35	93003-2746	A
93003-2023	NONE	1a 2a 2b 4b 5b	01c d30 04c d50	1/2 2/3 4/5		K36	93003-2732	A
93003-2024	NONE	2a	01c d50	2/3 4/5		K43	93003-2731	A
93003-2025	NONE	2a 4b	01c d20 d40	1/2 3/4		K44	93003-2730	A
93003-2026	NONE	2b	d20	1/2 4/5		K02	93003-2729	A
93003-2027	NONE	4b 5a	01c d30 04c d50	1/2 4/5		K45	93003-2728	A
93003-2028	NONE	NONE	01c d40	1/2 3/4		K46	93003-2727	A
93003-2029	NONE	1a 4b	d30	1/2 4/5		K04	93003-2726	A
93003-2030	NONE	1a 5b	d20 d40	1/2 3/4		K77	93003-2725	A
93003-2005	NONE	1b 2b 4a	d20 d30 d50	1/2 4/5		K40	93003-2744	A
93003-2016	NONE	3b 4a 5b	01c d30 d50	2/3 4/5		k47	93003-2738	A
93003-2018	NONE	1a 4b	01c	1/2 3/4		K48	93003-2736	A
93003-2020	NONE	1a 5b	d30 04c	2/3		K50	93003-2734	A
93003-2021	NONE	1b 2a 4a	01c 04c d50	1/2 4/5		K51	93003-2733	A
93003-2022	NONE	2b 3b 4a	01c d20 d40	1/2 3/4		K52	93003-2735	A
93003-2031	NONE	ALL	ALL	1/2 3/4		K00	93003-2724	A
93003-2032	3	2b	d30	1/2 4/5		N/A	93003-2723	B

6 CIRCUIT		SEE CODE DESIGNATION TABLE FOR NUMBERING FORMAT WHEN ADDING NEW PART NUMBERS						P.C.B. POLARISATION OPTION
PART NO. (TIN)	TERMINAL VOID POSITION	UNBLOCKED POSITION KEYS	UNBLOCKED CODING KEYS	LATCH POSITION	CONFIGURATION (SEE NOTES)	REF	PART NO. (SILVER)	
93003-2753	NONE	1b	03c d60	1/2 4/5		K01	93003-3499	A
93003-2754	NONE	1a 3b 4b	01c d50 06c	1/2 4/5		K30	93003-3498	A
93003-2755	NONE	1a 1b 2b 3a 3b 4b	d30 04c d50	1/2 2/3 4/5		K37	93003-3497	A
93003-2756	NONE	1a 1b 4a 4b	d10 d50	2/3 4/5		K39	93003-3496	A
93003-2757	NONE	2a 4b 5a 6b	d20 03c 05c	1/2 3/4 5/6		K42	93003-3495	A
93003-2758	NONE	1a 2b 3a 3b 5b 6b	01c d40 d60	1/2 3/4 5/6		K43	93003-3494	A
93003-2759	NONE	1b 2a 3a 4b 5a 5b 6b	01c 03c d60	1/2 3/4 5/6		K44	93003-3493	A
93003-2760	NONE	2b	d20 d60	1/2 5/6		K46	93003-3492	A
93003-2761	NONE	2b 3b 4a	01c d50 06c	1/2 4/5		K36	93003-3491	A
93003-2762	NONE	1b 4b	d20 03c d50 06c	1/2 4/5		K58	93003-3486	A
93003-2764	NONE	1a 2b 3b 4a 6b	01c 03c d40 05c d60	1/2 3/4 5/6		K59	93003-3485	A
93003-2765	NONE	1a 2b 4a 6b	01c d40	1/2 3/4 5/6		K62	93003-3484	A
93003-2763	NONE	1b 2b 3b	01c 05c d60	1/2 3/4 5/6		K51	93003-3490	A
93003-2766	NONE	1b	d20 03c	1/2 4/5		K55	93003-3489	A
93003-2767	NONE	1b 2a 3a 5a 5b	01c d20 03c d40 d60	1/2 3/4 5/6		K56	93003-3488	A
93003-2771	NONE	1a 3a 3b 5b 6a	01c d20 240 05c d60	1/2 3/4 5/6		K60	93003-3487	A
93003-2772	NONE	ALL	ALL	1/2 4/5		K00	93003-3483	A

SEE SHEET 1 EC NO: DRWN: BRUTTLE 2010/05/17 CHKD: T. TOURISH 2006/10/10 APPR: BMAGUIRE 2010/06/08 REV DESCRIPTION	QUALITY SYMBOLS	GENERAL TOLERANCES (UNLESS SPECIFIED)	SCALE 1:1	DESIGN UNITS METRIC	THIRD ANGLE PROJECTION	REVISE ON CAD ONLY
		mm INCH	DIMENSION STYLE		TITLE	
		4 PLACES ± --- ± ---	MM ONLY		RAST 5 R.A. HDR PA 66 HOUSING	
		3 PLACES ± --- ± ---	DRAWN BY DATE		MATERIAL NO. DOCUMENT NO. SHEET NO.	
	2 PLACES ± 0.1 ± ---	B. BRUTTLE 2006/10/10		SEE CHART SD-93003-001 4 OF 5		
	1 PLACE ± 0.2 ± ---	CHECKED BY DATE		MATERIAL NO. DOCUMENT NO. SHEET NO.		
	ANGULAR ± 2 °	T. TOURISH 2006/10/10		MATERIAL NO. DOCUMENT NO. SHEET NO.		
	DRAFT WHERE APPLICABLE	APPROVED BY DATE		MATERIAL NO. DOCUMENT NO. SHEET NO.		
	MUST REMAIN WITHIN DIMENSIONS	BMAGUIRE 2010/05/28		MATERIAL NO. DOCUMENT NO. SHEET NO.		
		THIS DRAWING CONTAINS INFORMATION THAT IS PROPRIETARY TO MOLEX INCORPORATED AND SHOULD NOT BE USED WITHOUT WRITTEN PERMISSION				

7 CIRCUIT		SEE CODE DESIGNATION TABLE FOR NUMBERING FORMAT WHEN ADDING NEW PART NUMBERS						P.C.B. POLARISATION OPTION
PART NO. (TIN)	TERMINAL VOID POSITION	UNBLOCKED POSITION KEYS	UNBLOCKED CODING KEYS	LATCH POSITION	CONFIGURATION (SEE NOTES)	REF	PART NO. (SILVER)	
93003-3500	NONE	NONE	03c d40 07c	1/2 5/6		K01	93003-4220	A
93003-3512	NONE	3a 4a	d30 d70	1/2 5/6		K30	93003-4248	A
93003-3504	NONE	2b	d20 d60	1/2 5/6		K32	93003-4247	A
93003-3513	NONE	1a 1b 3a 4b 5a	01c 07c	1/2 3/4 5/6		K40	93003-4240	A
93003-3514	NONE	2a	01c d50	2/3 4/5		K41	93003-4239	A
93003-3515	NONE	7b	01c d40 d70	1/2 3/4 6/7		K43	93003-4238	A
93003-3516	NONE	1b	03c d60	1/2 4/5		K31	93003-4237	A
93003-3517	NONE	1a 3a 4b 7b	01c d20 03c 06c	1/2 3/4 6/7		K45	93003-4236	A
93003-3518	NONE	1b 7a	02c d50	2/3 6/7		K48	93003-4235	A
93003-3519	NONE	1a 2b 3a 4b 6a	d20 03c d40 d50 d70	1/2 3/4 6/7		K51	93003-4234	A
93003-3520	NONE	1b 6a	d20 03c d50 d70	1/2 3/4 6/7		K69	93003-4233	A
93003-3505	NONE	1b 2a 5a 5b 7b	d20 d50 06c d70	1/2 4/5 6/7		K34	93003-4246	A
93003-3506	NONE	2b	d20 07c	1/2 3/4 5/6		K35	93003-4245	A
93003-3507	NONE	2a 2b 4b 5b 6a	d20 03c d40 d60	1/2 3/4 5/6		K38	93003-4244	A
93003-3510	NONE	2b 4a 4b 5b 6a	01c d20 d40 d60	1/2 3/4 5/6		K42	93003-4241	A
93003-3521	NONE	ALL	ALL	1/2 5/6		K00	93003-4232	A

SEE SHEET 1	EC NO: 2010/05/17 DRWN: BRUTTLE 2010/05/17 CHKD: T. TOURISH 2006/10/10 APPR: BMAGUIRE 2010/06/08	QUALITY SYMBOLS 0 0.0	GENERAL TOLERANCES (UNLESS SPECIFIED)		SCALE 1:1	DESIGN UNITS METRIC	THIRD ANGLE PROJECTION	REVISE ON CAD ONLY																
			<table border="1"> <tr> <th></th> <th>mm</th> <th>INCH</th> </tr> <tr> <td>4 PLACES</td> <td>± ---</td> <td>± ---</td> </tr> <tr> <td>3 PLACES</td> <td>± ---</td> <td>± ---</td> </tr> <tr> <td>2 PLACES</td> <td>± 0.1</td> <td>± ---</td> </tr> <tr> <td>1 PLACE</td> <td>± 0.2</td> <td>± ---</td> </tr> </table>			mm	INCH	4 PLACES	± ---	± ---	3 PLACES	± ---	± ---	2 PLACES	± 0.1	± ---	1 PLACE	± 0.2	± ---	DIMENSION STYLE MM ONLY		TITLE RAST 5 R.A. HDR PA 66 HOUSING		
				mm	INCH																			
			4 PLACES	± ---	± ---																			
3 PLACES	± ---	± ---																						
2 PLACES	± 0.1	± ---																						
1 PLACE	± 0.2	± ---																						
DRAFT WHERE APPLICABLE MUST REMAIN WITHIN DIMENSIONS		APPROVED BY DATE T. TOURISH 2006/10/10		DRAWN BY DATE B. RUTTLE 2006/10/10		MATERIAL NO. DOCUMENT NO. SHEET NO. SEE CHART SD-93003-001 5 OF 5																		
		ANGULAR ± 2 °		CHECKED BY DATE BMAGUIRE 2010/05/28		MOLEX INCORPORATED THIS DRAWING CONTAINS INFORMATION THAT IS PROPRIETARY TO MOLEX INCORPORATED AND SHOULD NOT BE USED WITHOUT WRITTEN PERMISSION																		