

# Data Sheet

## PD185U03-080

### Power Divider/Combiner

#### 2-Way 0° 50Ω 1.65-2.05 GHz



### Features

- Small Size (2x2mm DFN package)
- Passive RF IC, no need external DC power supply
- No need external 100 Ω resistor
- Very Low Loss
- Tight Amplitude Balance
- High Isolation
- Low VSWR
- Good Repeatability
- Tape & Reel
- Operating Temperature -40°C~85°C
- Power handling
  - 2 Watts as a divider
  - 1 Watts as a combiner

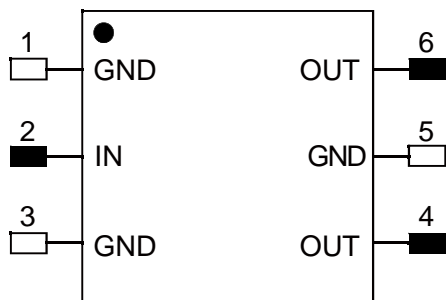
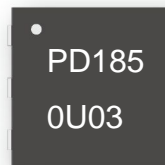
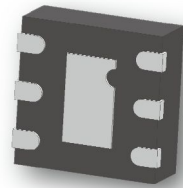

TOP VIEW

### Applications

- Wireless communications
- WLAN / WiMax
- SAT Radio
- ISM band instrument
- Information System for Automotive Safety

#### Notes:

1. This part has passed through 100% RF test.
2. Suggest to add Capacitors of DC Blocker between Pins(with black color) and external circuit to prevent DC signal entry to guarantee parts normal work.
3. Suggest to add a TVS Diode in parallel between Electrode (with black color) and Capacitor of DC Blocker to provide ESD protection for the product. TVS Diode use ON Semiconductor's ESD9101 is recommended.

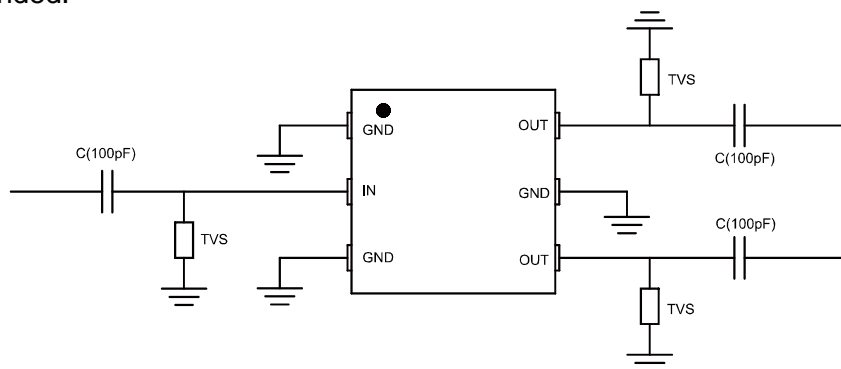

#### ESD Rating

Human Body Model (HBM): ≤ 800V in accordance with ANSI/ESD STM 5.1 - 2001

Machine Model (MM): ≤ 100V in accordance with ANSI/ESD STM 5.2 - 1999

### Yantel Corporation

Add: 3F, Building 3, Southern District 2 of Zhongguan Honghualing Industrial Park, Xili, Nanshan, Shenzhen, China  
 Tel: 86-755-8355-1886 Fax: 86-755-8355-2533

# Data Sheet

## PD1850U03-080

Power Divider/Combiner  
2-Way 0° 50Ω 1.65-2.05 GHz



### Electrical Specifications at 25° C

Parameter	Symbol	Min	Typ	Max	Unit
Frequency Range	F	1650		2050	MHz
Insertion Loss (Above 3dB)	$I_L$		0.25	0.45	dB
Isolation	Isol	16	20		dB
Phase balance	$\varnothing_{bal}$		1	2	deg
Amplitude balance	$A_{bal}$		0.05	0.15	dB
Input VSWR			1.2	1.4	
Output VSWR			1.15	1.25	

### Typical Performance (-40°C, 25°C, 85°C, 125°C: 1650-2050 MHz)

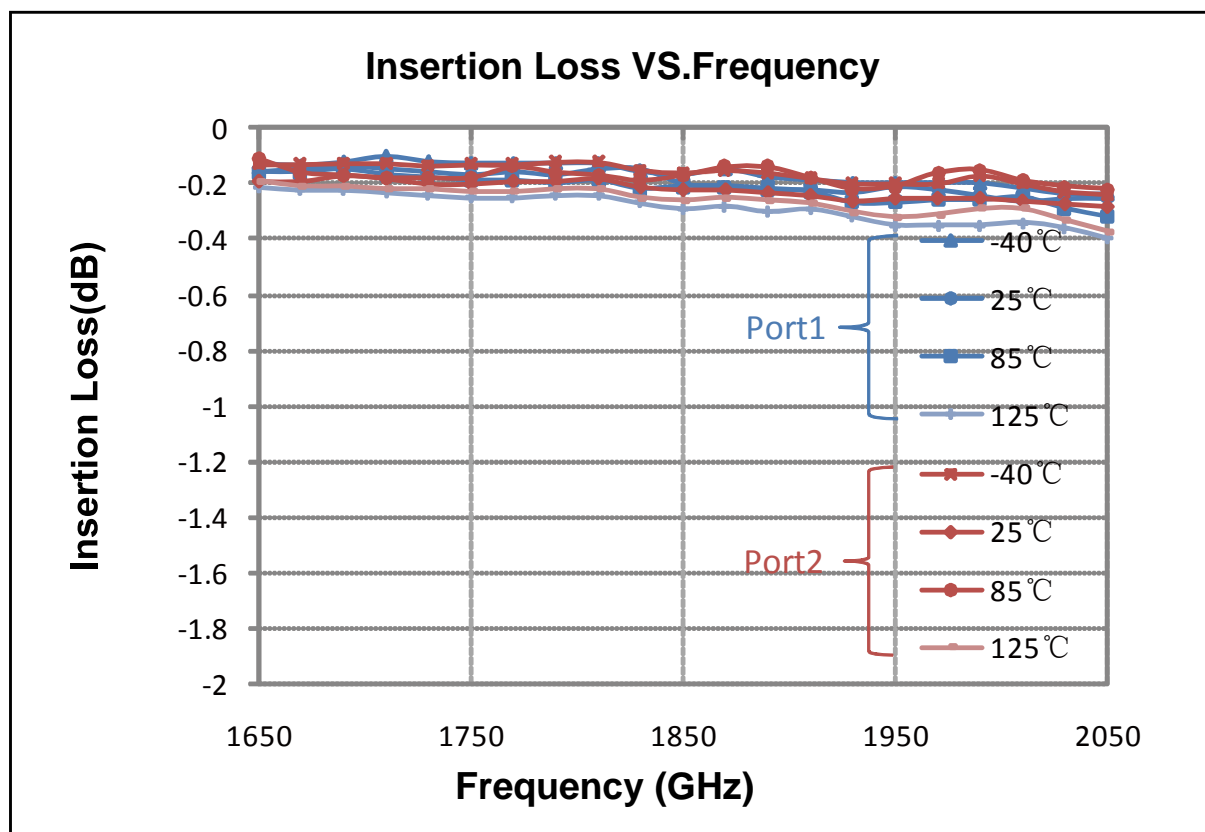

### Yantel Corporation

Add: 3F, Building 3, Southern District 2 of Zhongguan Honghualing Industrial Park, Xili, Nanshan, Shenzhen, China  
Tel: 86-755-8355-1886 Fax: 86-755-8355-2533

# Data Sheet

## PD1850U03-080

Power Divider/Combiner  
2-Way 0° 50Ω 1.65-2.05 GHz

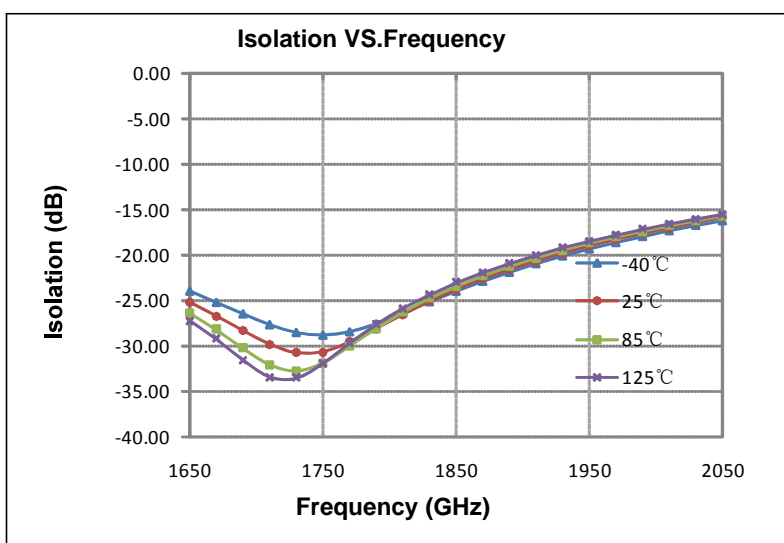
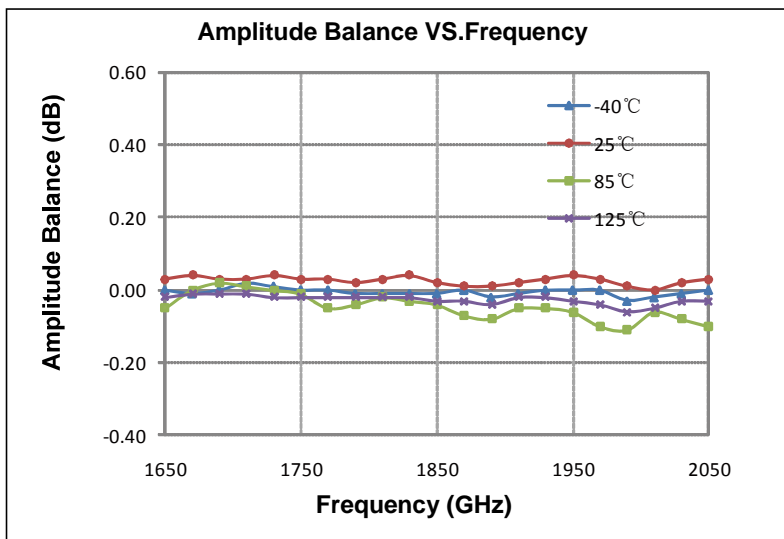
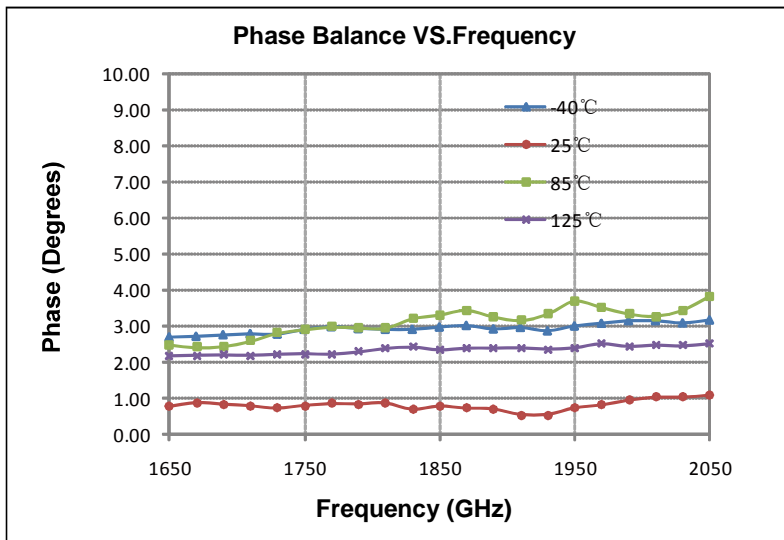

### Yantel Corporation

Add: 3F, Building 3, Southern District 2 of Zhongguan Honghualing Industrial Park, Xili, Nanshan, Shenzhen, China  
Tel: 86-755-8355-1886 Fax: 86-755-8355-2533

# Data Sheet

## PD1850U03-080

Power Divider/Combiner  
2-Way 0° 50Ω 1.65-2.05 GHz

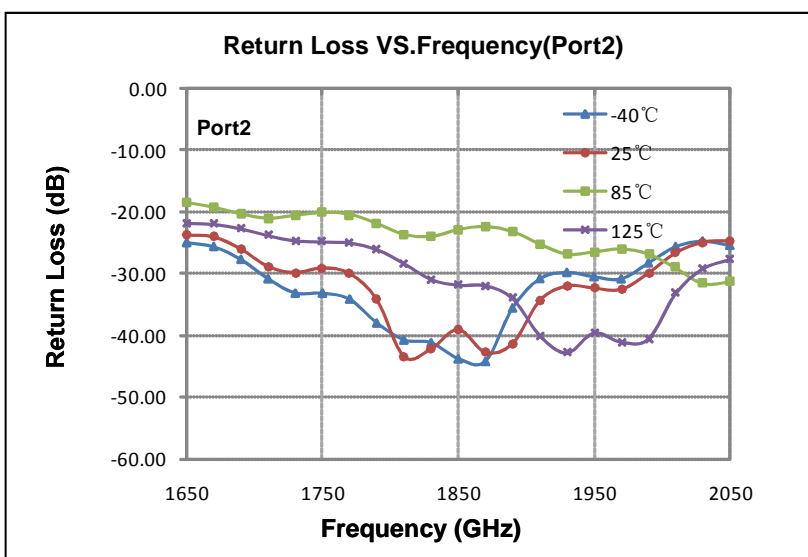
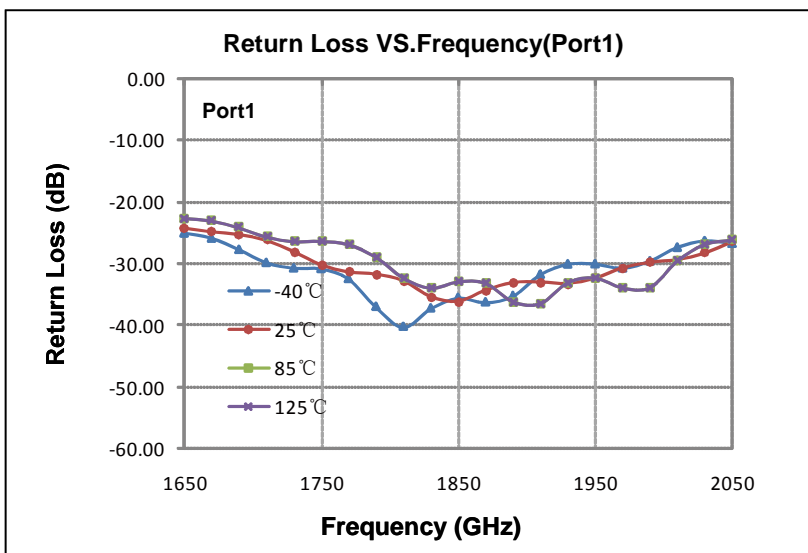
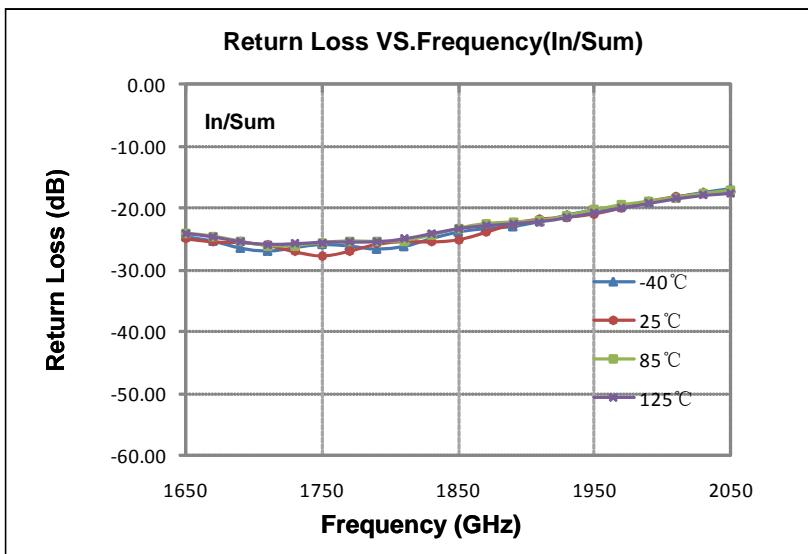

### Yantel Corporation

Add: 3F, Building 3, Southern District 2 of Zhongguan Honghualing Industrial Park, Xili, Nanshan, Shenzhen, China

Tel: 86-755-8355-1886 Fax: 86-755-8355-2533

# Data Sheet

## PD1850U03-080

### Power Divider/Combiner

### 2-Way 0° 50Ω 1.65-2.05 GHz



## Outline Drawing

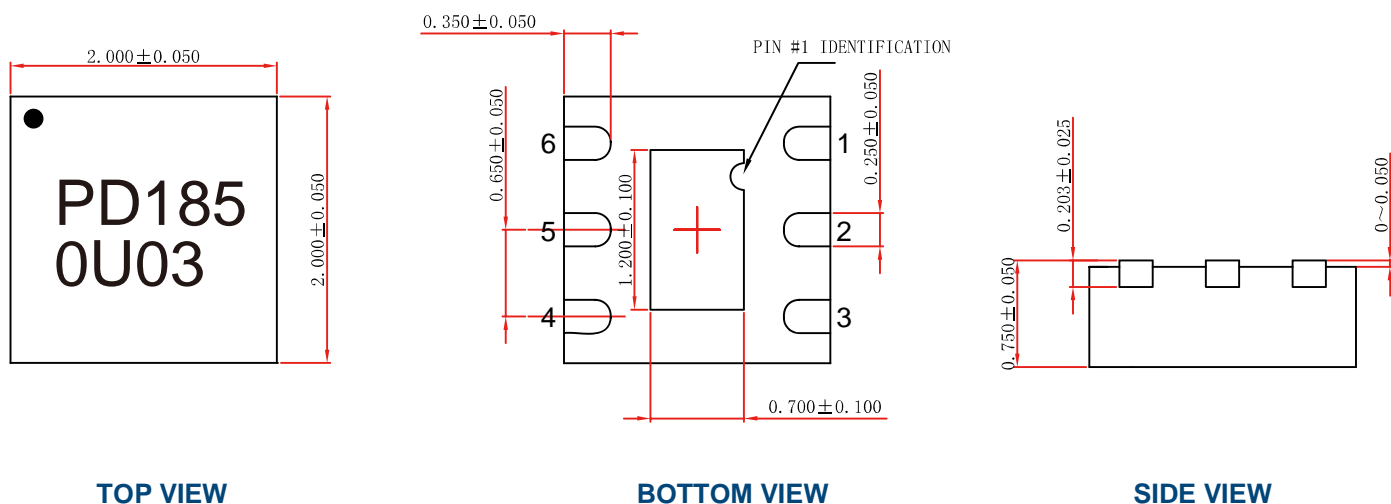

## Land Pattern

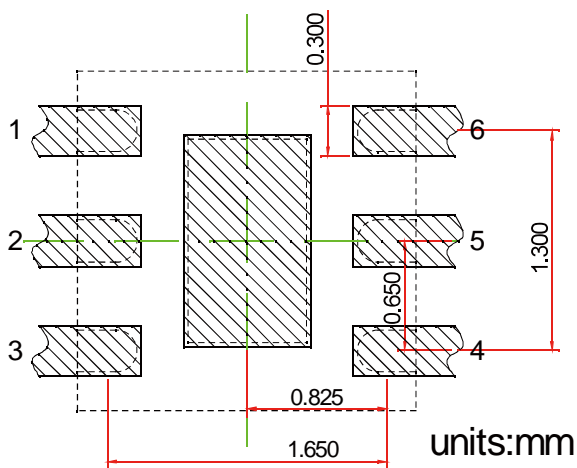

## Recommended Land Pattern Top View

Notes: All dimensions show in millimeters

## Pin Out

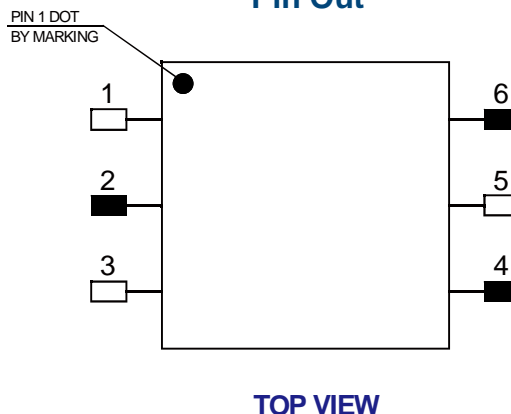

Notes:

1. Require to add Capacitors of DC Blocker between Pins (with black color) and external circuit to prevent DC signal entry to guarantee parts normal work.
2. This part has passed through 100% RF test.

Pin #	Connection
1	GND
2	IN
3	GND
4	OUT
5	GND
6	OUT

## Yantel Corporation

Add: 3F, Building 3, Southern District 2 of Zhongguan Honghualing Industrial Park, Xili, Nanshan, Shenzhen, China

Tel: 86-755-8355-1886 Fax: 86-755-8355-2533

Rev A4

For detailed performance specs & shopping online see Yantel web site : [www.yantel-corp.com](http://www.yantel-corp.com)