

PLEASE CHECK WWW.MOLEX.COM FOR LATEST PART INFORMATION

Part Number: [0712510008](#)
Status: **Active**
Description: 1.27mm (.050") Pitch DIMM Socket, Vertical, Multiple Keys, Plastic Peg, 168 Circuits, 5.0V Standard DRAM

Documents:

[3D Model](#) [Product Specification PS-71243-9999 \(PDF\)](#)
[Drawing \(PDF\)](#) [RoHS Certificate of Compliance \(PDF\)](#)

Agency Certification

CSA LR19980
 UL E29179

General

Product Family Memory Module Sockets
 Series [71251](#)
 Comments Function Key Center, Voltage Key Offset Left
 Component Type Memory Module
 JEDEC Outline MO-161
 Product Name DIMM

Physical

Circuits (Loaded) 168
 Circuits (maximum) 168
 Color - Resin Black, Natural
 Durability (mating cycles max) 25
 Entry Angle Vertical (Top Entry)
 Flammability 94V-0
 Function Key Center
 Keying to Mating Part Yes
 Material - Metal Phosphor Bronze
 Material - Plating Mating Gold
 Material - Plating Termination Tin
 Material - Resin High Temperature Thermoplastic
 PC Tail Length (in) 0.127 In
 PC Tail Length (mm) 3.23 mm
 PCB Locator Yes
 PCB Retention Yes
 PCB Thickness Recommended (in) 0.062 In
 PCB Thickness Recommended (mm) 1.57 mm
 Packaging Type Tray
 Pitch - Mating Interface (in) 0.050 In
 Pitch - Mating Interface (mm) 1.27 mm
 Pitch - Term. Interface (in) 0.050 In
 Pitch - Term. Interface (mm) 1.27 mm
 Plating min: Mating (µin) 2
 Plating min: Mating (µm) 0.05
 Plating min: Termination (µin) 150
 Plating min: Termination (µm) 3.81
 Temperature Range - Operating -40°C to +85°C
 Termination Interface: Style Through Hole

Electrical

Current - Maximum per Contact 1A
 Voltage - Maximum 100V AC (RMS)/DC
 Voltage Key Left

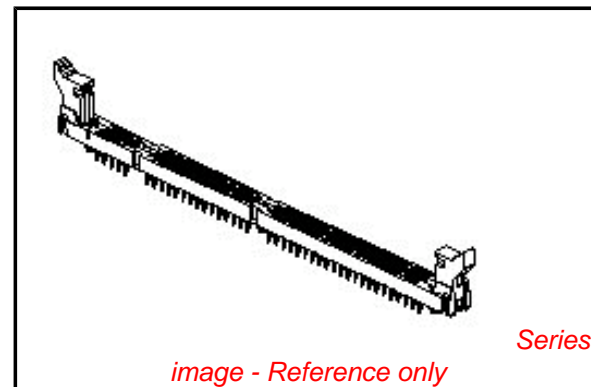

EU RoHS

ELV and RoHS Compliant
REACH SVHC
 Not Reviewed
Halogen-Free Status
 Not Reviewed

China RoHS



Need more information on product environmental compliance?

Email productcompliance@molex.com
 For a multiple part number RoHS Certificate of Compliance, [click here](#)

Please visit the [Contact Us](#) section for any non-product compliance questions.

Search Parts in this Series

[71251Series](#)

Mates With

JEDEC MO-161 modules

Solder Process Data

Lead-free Process Capability

Wave Capable (TH only)

Material Info

Old Part Number

A712510008

Reference - Drawing Numbers

Product Specification

PS-71243-9999

Sales Drawing

SDA-71251-0***

This document was generated on 04/13/2010

PLEASE CHECK WWW.MOLEX.COM FOR LATEST PART INFORMATION

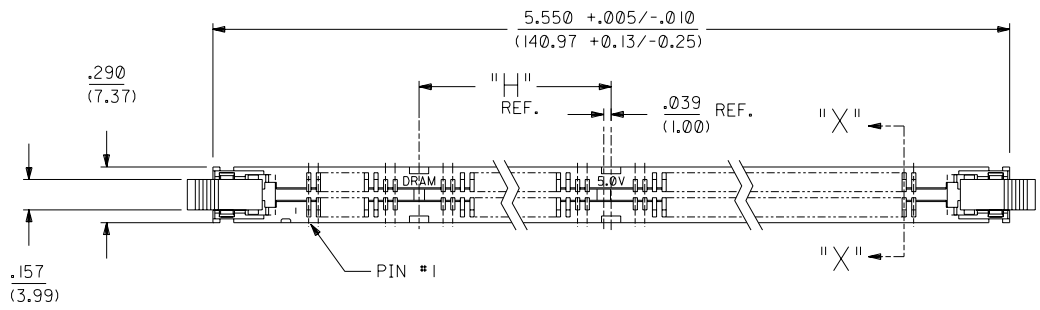

- NOTES:
- CARD SLOT ACCEPTS $.050 \pm .004$ (1.27 ± 0.10) MODULE THICKNESS. (MEASURED OVER P.C. PADS).
 - ALL PEGS ARE INTERFERENCE FITS TO PCB UNLESS NOTED ON THE DWG.
 - REFER TO PRODUCT SPEC PS-71243-9999 FOR PERFORMANCE SPECIFICATIONS.
 - PRODUCT IS PACKAGED IN TRAYS.
 - RECOMMENDED MODULE LAYOUT SHALL BE PER JEDEC MO-161.
 - RECOMMENDED PLATING ON MODULE PADS: 30 MICROINCH/(0.76 MICROMETER) MINIMUM HARD GOLD (Au) OVER 79 MICROINCH/(2.0 MICROMETER) MINIMUM NICKEL (Ni).
 - SEE CHART FOR HOLE SIZE AND PRESENCE AND PLATING OPTION.
 - PRODUCT WILL HAVE DATE CODE STAMPED ON SIDE OF HOUSING.

MATERIALS:
 HOUSING - GLASS FILLED LIQUID CRYSTAL POLYMER (LCP), UL 94V-0, COLOR: BLACK.
 TERMINAL - PHOSPHOR BRONZE
 LATCHES - GLASS FILLED HIGH TEMPERATURE NYLON, UL 94V-0, COLOR: IVORY.

PLATING:
 CONTACT AREA: OPTION A: GOLD (Au) FLASH; THICKNESS=2-10 MICROINCH/(0.05-0.25 (0.05-0.25 MICROMETER), OVER PALLADIUM-NICKEL (Pd-Ni); THICKNESS=30 MICROINCH/(0.76 MICROMETER) MINIMUM.
 OPTION B: GOLD (Au) FLASH; THICKNESS=2-10 MICROINCH/(0.05-0.25 MICROMETER), OVER PALLADIUM-NICKEL (Pd-Ni); THICKNESS=20 MICROINCH/(0.51 MICROMETER) MINIMUM.

SOLDER TAILS: TIN (Sn); THICKNESS=150 MICROINCH/(3.81 MICROMETER) MINIMUM.
 UNDERPLATE: NICKEL (Ni) OVER ENTIRE CONTACT.

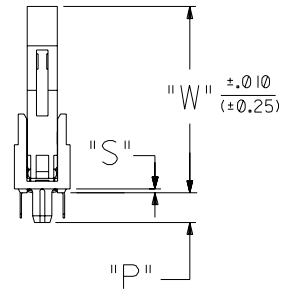

NOTE FOR LEAD FREE CONVERSION:
 THE PRIMARY SHIPPING CARTON WILL BE LABELED "COMPLIANT TO RoHS DIRECTIVE 2002/95/EC AND ELV ANNEX II OF DIRECTIVE 2000/53/EC". CARTONS WITHOUT THIS LABEL MAY CONTAIN PRODUCT WITH LEAD.

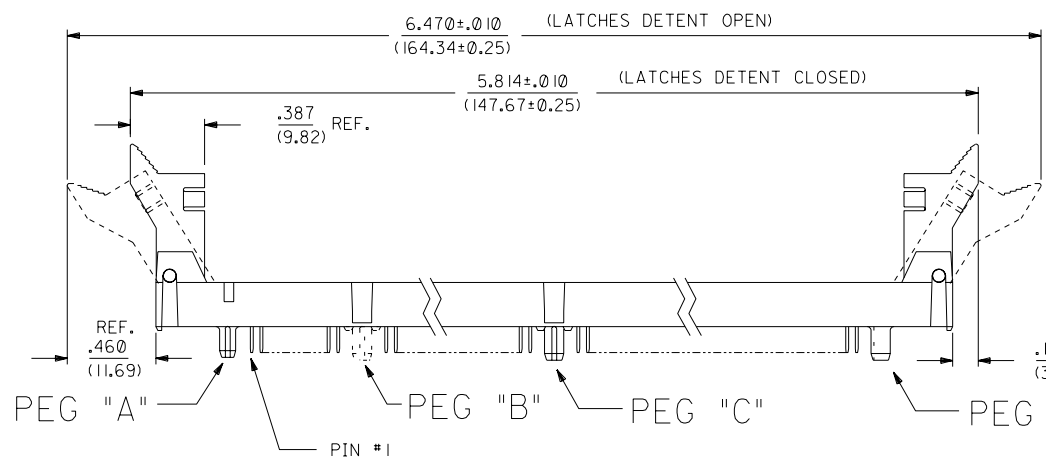

71251-0004 SHOWN

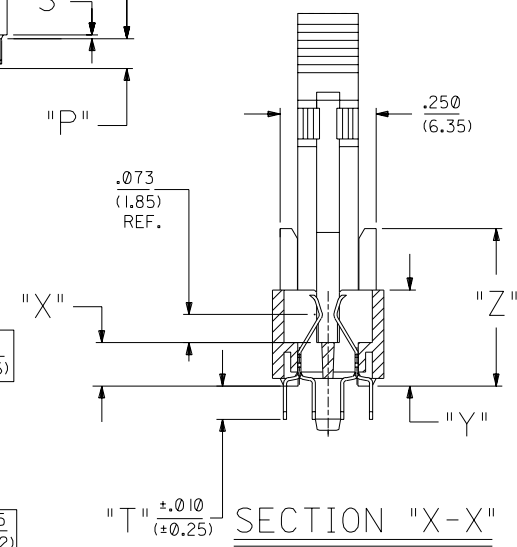
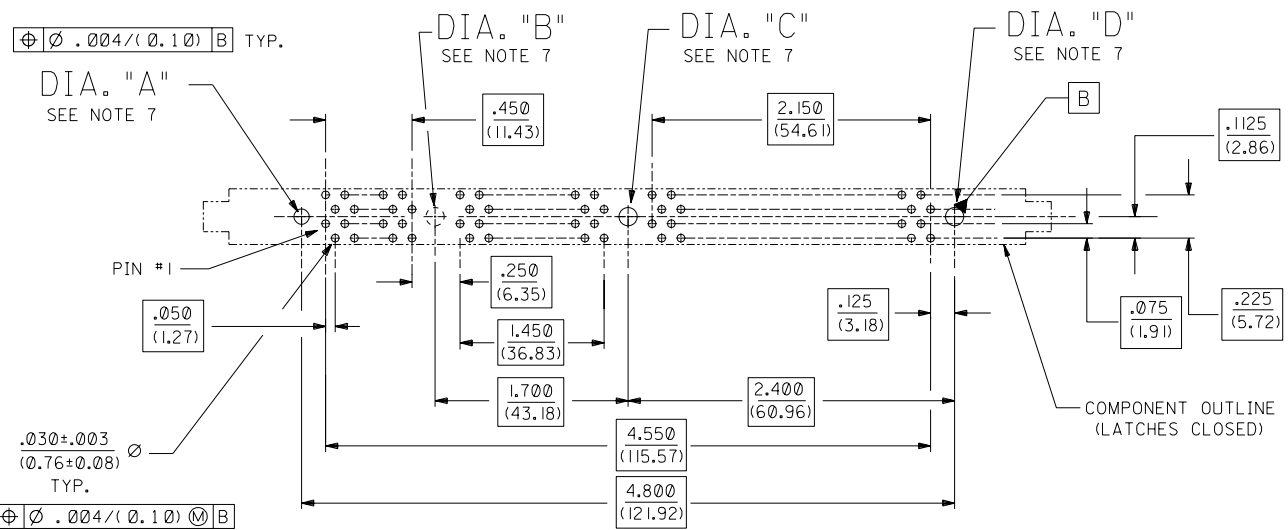

SCALE 4:1

REV.	DATE	BY	CHK'D.	SCALE
3	H			
2	F3			
1	HI			

DIMENSIONS SHOWN (METRIC) INCH UNLESS OTHERWISE SPECIFIED TOLERANCES: ANGULAR $\pm 1/2^\circ$		REVISE ONLY ON CAD SYSTEM	
3 PLAGE $\pm .005$	INCH	TITLE $.050 / (1.27)$ PITCH MULTI-KEY 168 CKT DIMM RAM ASSY 17.8mm LATCH SALES DWG	
2 PLAGE $\pm \dots \pm 0.13$	METRIC	MOLEX INCORPORATED SHEET NO. DATE U.S.A. 1 OF 3 10 / 10 / 94	
1 PLAGE $\dots \pm 0.25$		PART NO. DRWG. NO. SEE CHART SDA-71251-0***	
DRAFT WHERE APPLICABLE MUST REMAIN WITHIN DIMENSIONS		APPROV. BY DCB FILE NAME: ST125101.DGN THIS DRAWING CONTAINS INFORMATION THAT IS PROPRIETARY TO MOLEX INC. AND SHOULD NOT BE USED WITHOUT WRITTEN PERMISSION	

HI	ADD LEAD FREE NOTE ECON# UC2004-1732 DMORGAN 04/03/09
H	RELEASE -0027 ECON# UD2000-1151 DMORGAN 00/05/19
H	RELEASE -0027 ECON# UD2000-1151 DMORGAN 00/05/19
G	CHG Sn-Pb THICKNESS ECON# UD1999-0454 DMORGAN 99/08/09
F3	REVISED PER ECON# U80435 97-8-8 LAURX
F2	REVISED PER ECON# U71162 97-4-15 LAURX
F1	REVISED PER ECON# U70361 96-10-9 LAURX
F	REVISED PER ECON# U61133 96-9-25 LAURX
E1	REVISED PER ECON# U60836 1-19-96 JCL
E	REVISED PER ECON# U60682 12-7-95 JCL
D2	REVISED PER ECON# U60452 10-10-95 JCL
D1	REVISED PER ECON# U60361 9-18-95 JCL
D	REVISED PER ECON# U51288 8-4-95 JCL

PART NUMBER	COLOR	DESCRIPTION	FUNCTION KEY	VOLTAGE KEY	DIA. "A"	DIA. "B"	DIA. "C"	DIA. "D"	DIM. "H"	DIM. "P"	DIM. "S"	DIM. "T"	DIM. "W"	DIM. "X"	DIM. "Y"	DIM. "Z"	CONTACT AREA PLATING
71251-0001	BLACK	3.3 VOLT STD DRAM	CENTER	CENTER	.080±.002 (2.03±0.05)	NONE	.093 +.003/-0.00 (2.36+0.08/-0.00)	.093 +.003/-0.00 (2.36+0.08/-0.00)	1.700 (43.18)	.155 (3.94)	.020 (0.51)	.127 (3.23)	.970 (24.64)	.113 (2.87)	.250 (6.35)	.410 (10.41)	OPTION A
71251-0004	BLACK	5.0 VOLT STD DRAM	CENTER	OFFSET LEFT	.080±.002 (2.03±0.05)	NONE	.093 +.003/-0.00 (2.36+0.08/-0.00)	.093 +.003/-0.00 (2.36+0.08/-0.00)	1.700 (43.18)	.155 (3.94)	.020 (0.51)	.127 (3.23)	.970 (24.64)	.113 (2.87)	.250 (6.35)	.410 (10.41)	OPTION A
71251-0012	BLACK	3.3 VOLT UNBUFFERED	OFFSET RIGHT	CENTER	.080±.002 (2.03±0.05)	NONE	.093 +.003/-0.00 (2.36+0.08/-0.00)	.093 +.003/-0.00 (2.36+0.08/-0.00)	1.661 (42.19)	.155 (3.94)	.020 (0.51)	.127 (3.23)	.970 (24.64)	.113 (2.87)	.250 (6.35)	.410 (10.41)	OPTION A
71251-0013	BLACK	5.0 VOLT UNBUFFERED	OFFSET RIGHT	OFFSET LEFT	.080±.002 (2.03±0.05)	NONE	.093 +.003/-0.00 (2.36+0.08/-0.00)	.093 +.003/-0.00 (2.36+0.08/-0.00)	1.661 (42.19)	.155 (3.94)	.020 (0.51)	.127 (3.23)	.970 (24.64)	.113 (2.87)	.250 (6.35)	.410 (10.41)	OPTION A
71251-0016	BLACK	3.3 VOLT SYNCHRONOUS	OFFSET LEFT	CENTER	.080±.002 (2.03±0.05)	NONE	.093 +.003/-0.00 (2.36+0.08/-0.00)	.093 +.003/-0.00 (2.36+0.08/-0.00)	1.739 (44.17)	.155 (3.94)	.020 (0.51)	.127 (3.23)	.970 (24.64)	.113 (2.87)	.250 (6.35)	.410 (10.41)	OPTION A
71251-0017	BLACK	5.0 VOLT SYNCHRONOUS	OFFSET LEFT	OFFSET LEFT	.080±.002 (2.03±0.05)	NONE	.093 +.003/-0.00 (2.36+0.08/-0.00)	.093 +.003/-0.00 (2.36+0.08/-0.00)	1.739 (44.17)	.155 (3.94)	.020 (0.51)	.127 (3.23)	.970 (24.64)	.113 (2.87)	.250 (6.35)	.410 (10.41)	OPTION A

NOTES:

1. STRAIGHTNESS OF MODULE APPLIES TO THE AREA FROM THE BOTTOM OF THE CARD UP .157/(4.00).
2. IF TIE BARS ARE ATTACHED TO PADS, THE TIE BAR SHOULD BE ON AN INTERNAL LAYER, SO THAT THE REMNANT CANNOT CAUSE DAMAGE TO THE CONTACTS.

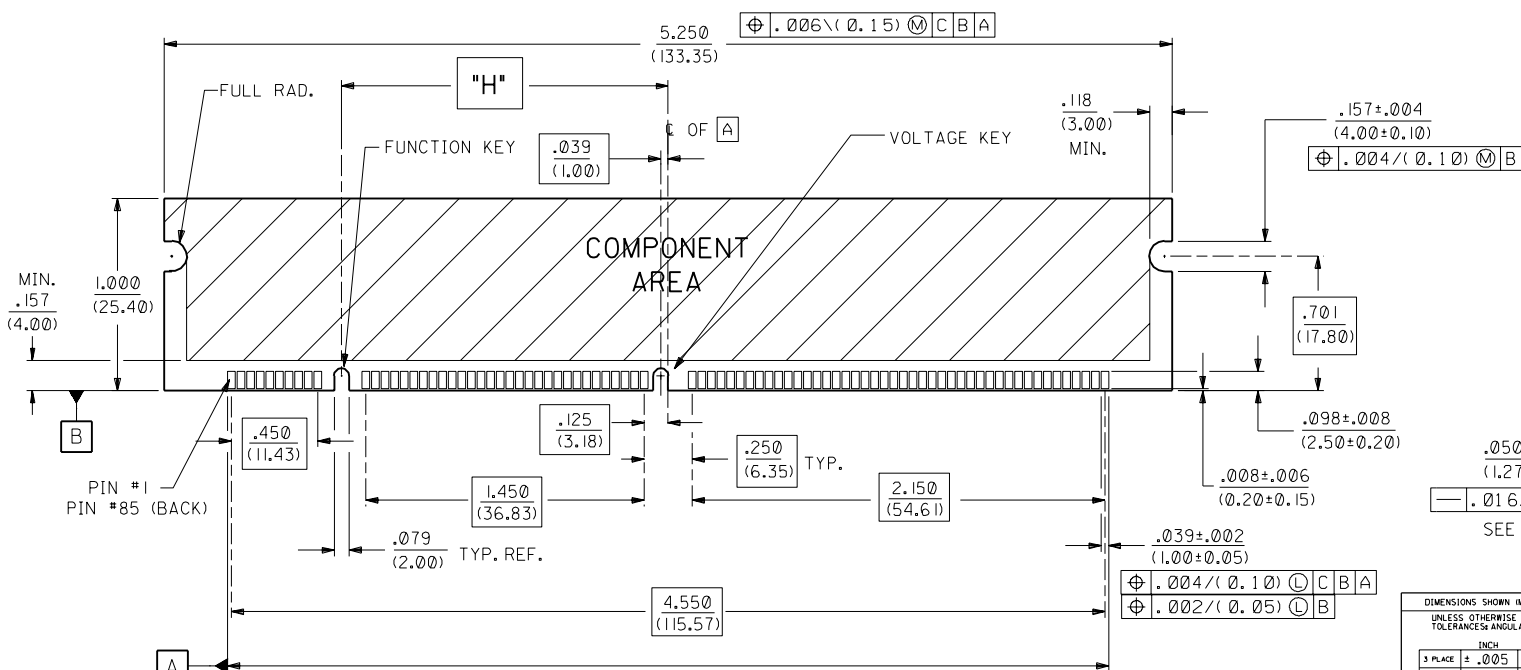
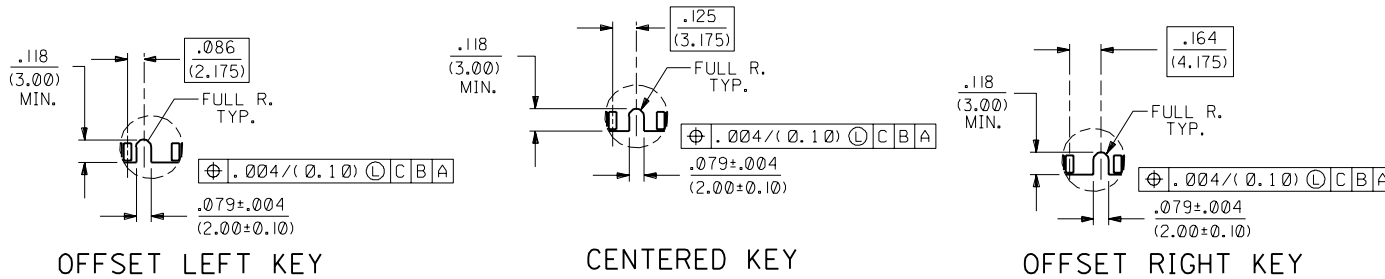

F3	SEE SHEET I
F2	SEE SHEET I
F1	SEE SHEET I
F	SEE SHEET I
E1	SEE SHEET I
E	SEE SHEET I
D2	SEE SHEET I
D1	SEE SHEET I
D	SEE SHEET I
C	SEE SHEET I
B1	SEE SHEET I
B	SEE SHEET I
A	SEE SHEET I

DIMENSIONS SHOWN (METRIC) INCH UNLESS OTHERWISE SPECIFIED TOLERANCES ANGULAR ± 1/2°		TITLE .050/(1.27) PITCH MULTI-KEY 168 CKT DIMM RAM ASSY 17.8mm LATCH SALES DWG.	
3 PLACE ± .005	INCH	---	METRIC
2 PLACE ± .01	---	± 0.13	---
1 PLACE ---	---	± 0.25	---
DRAFT WHERE APPLICABLE MUST REMAIN WITHIN DIMENSIONS		MFG. SH. REV. LTR. REVISIONS	
DRAWING NO. 71251-0001		PART NO. 71251-0001	
DRWG. BY: DCB		DRWG. NO. 71251-0001	
CHK'D BY: DCB		DATE: 10/10/94	
APP'D BY: DCB		SCALE: 2:1	
FILE NAME: ST 25102		DIV. CP	
SEE CHART		THIS DRAWING CONTAINS INFORMATION THAT IS PROPRIETARY TO MOLEX INC. AND SHOULD NOT BE USED WITHOUT WRITTEN PERMISSION.	

13		12		11		10		9		8		7		6		71251		4		3		2		1	
PART NUMBER	COLOR	DESCRIPTION	FUNCTION KEY	VOLTAGE KEY	DIA. "A"	DIA. "B"	DIA. "C"	DIA. "D"	DIM. "H"	DIM. "P"	DIM. "S"	DIM. "T"	DIM. "W"	DIM. "X"	DIM. "Y"	DIM. "Z"	CONTACT AREA PLATING								
71251-0001	BLACK	3.3 VOLT STD DRAM	SEE SHEET 2																						OPTION A
71251-0002	BLACK	3.3 VOLT STD DRAM	CENTER	CENTER	NONE	$\frac{.093 + .003}{(2.36 + 0.08)}$ / $\frac{-0.000}{(-0.00)}$	$\frac{.093 + .003}{(2.36 + 0.08)}$ / $\frac{-0.000}{(-0.00)}$	NONE	1.700 (43.18)	.155 (3.94)	.020 (0.51)	.127 (3.23)	.970 (24.64)	.113 (2.87)	.250 (6.35)	.410 (10.41)									OPTION A
71251-0003	BLACK	5.0 VOLT STD DRAM	CENTER	OFFSET LEFT	NONE	$\frac{.093 + .003}{(2.36 + 0.08)}$ / $\frac{-0.000}{(-0.00)}$	$\frac{.093 + .003}{(2.36 + 0.08)}$ / $\frac{-0.000}{(-0.00)}$	NONE	1.700 (43.18)	.155 (3.94)	.020 (0.51)	.127 (3.23)	.970 (24.64)	.113 (2.87)	.250 (6.35)	.410 (10.41)									OPTION A
71251-0004	BLACK	5.0 VOLT STD DRAM	SEE SHEET 2																						OPTION A
71251-0005	BLACK	5.0 VOLT UNBUFFERED	OFFSET RIGHT	OFFSET LEFT	$\frac{.080 \pm .002}{(2.03 \pm 0.05)}$	NONE	NONE	$\frac{.080 \pm .002}{(2.03 \pm 0.05)}$	1.661 (42.19)	.125 (3.18)	.035 (0.89)	.102 (2.59)	.985 (25.02)	.128 (3.25)	.265 (6.73)	.425 (10.79)									OPTION A
71251-0006	BLACK	5.0 VOLT STD DRAM	CENTER	OFFSET LEFT	$\frac{.080 \pm .002}{(2.03 \pm 0.05)}$	NONE	$\frac{.093 + .003}{(2.36 + 0.08)}$ / $\frac{-0.000}{(-0.00)}$	$\frac{.080 \pm .002}{(2.03 \pm 0.05)}$	1.700 (43.18)	.155 (3.94)	.020 (0.51)	.127 (3.23)	.970 (24.64)	.113 (2.87)	.250 (6.35)	.410 (10.41)									OPTION A
71251-0007	BLACK	3.3 VOLT STD DRAM	CENTER	CENTER	$\frac{.080 \pm .002}{(2.03 \pm 0.05)}$	NONE	$\frac{.080 \pm .002}{(2.03 \pm 0.05)}$	$\frac{.080 \pm .002}{(2.03 \pm 0.05)}$	1.700 (43.18)	.140 (3.56)	.020 (0.51)	.127 (3.23)	.970 (24.64)	.113 (2.87)	.250 (6.35)	.410 (10.41)									OPTION A
71251-0008	BLACK	5.0 VOLT STD DRAM	CENTER	OFFSET LEFT	NONE	$\frac{.093 + .003}{(2.36 + 0.08)}$ / $\frac{-0.000}{(-0.00)}$	$\frac{.093 + .003}{(2.36 + 0.08)}$ / $\frac{-0.000}{(-0.00)}$	$\frac{.093 + .003}{(2.36 + 0.08)}$ / $\frac{-0.000}{(-0.00)}$	1.700 (43.18)	.155 (3.94)	.020 (0.51)	.127 (3.23)	.970 (24.64)	.113 (2.87)	.250 (6.35)	.410 (10.41)									OPTION A
71251-0009	BLACK	5.0 VOLT STD DRAM	CENTER	OFFSET LEFT	$\frac{.080 \pm .002}{(2.03 \pm 0.05)}$	NONE	NONE	$\frac{.080 \pm .002}{(2.03 \pm 0.05)}$	1.700 (43.18)	.125 (3.18)	.035 (0.89)	.102 (2.59)	.985 (25.02)	.128 (3.25)	.265 (6.73)	.425 (10.79)									OPTION A
71251-0010	BEIGE	3.3 VOLT STD DRAM	CENTER	CENTER	$\frac{.080 \pm .002}{(2.03 \pm 0.05)}$	NONE	NONE	$\frac{.080 \pm .002}{(2.03 \pm 0.05)}$	1.700 (43.18)	.125 (3.18)	.035 (0.89)	.112 (2.84)	.985 (25.02)	.128 (3.25)	.265 (6.73)	.425 (10.79)									OPTION A
71251-0011	BLACK	3.3 VOLT STD DRAM	CENTER	CENTER	$\frac{.093 + .003}{(2.36 + 0.08)}$ / $\frac{-0.000}{(-0.00)}$	NONE	$\frac{.093 + .003}{(2.36 + 0.08)}$ / $\frac{-0.000}{(-0.00)}$	$\frac{.093 + .003}{(2.36 + 0.08)}$ / $\frac{-0.000}{(-0.00)}$	1.700 (43.18)	.155 (3.94)	.020 (0.51)	.127 (3.23)	.970 (24.64)	.113 (2.87)	.250 (6.35)	.410 (10.41)									OPTION A
71251-0012	BLACK	3.3 VOLT UNBUFFERED	SEE SHEET 2																						OPTION A
71251-0013	BLACK	5.0 VOLT UNBUFFERED	SEE SHEET 2																						OPTION A
71251-0014	BLACK	3.3 VOLT UNBUFFERED	OFFSET RIGHT	CENTER	$\frac{.080 \pm .002}{(2.03 \pm 0.05)}$	NONE	NONE	$\frac{.080 \pm .002}{(2.03 \pm 0.05)}$	1.661 (42.19)	.125 (3.18)	.035 (0.89)	.112 (2.84)	.985 (25.02)	.128 (3.25)	.265 (6.73)	.425 (10.79)									OPTION A
71251-0015	BLACK	3.3 VOLT STD DRAM	CENTER	CENTER	$\frac{.080 \pm .002}{(2.03 \pm 0.05)}$	NONE	$\frac{.093 + .003}{(2.36 + 0.08)}$ / $\frac{-0.000}{(-0.00)}$	$\frac{.093 + .003}{(2.36 + 0.08)}$ / $\frac{-0.000}{(-0.00)}$	1.700 (43.18)	.155 (3.94)	.020 (0.51)	.117 (2.97)	.970 (24.64)	.113 (2.87)	.250 (6.35)	.410 (10.41)									OPTION A
71251-0016	BLACK	3.3 VOLT SYNCHRONOUS	SEE SHEET 2																						OPTION A
71251-0017	BLACK	5.0 VOLT SYNCHRONOUS	SEE SHEET 2																						OPTION A
71251-0018	BLACK	3.3 VOLT UNBUFFERED	OFFSET RIGHT	CENTER	$\frac{.093 + .003}{(2.36 + 0.08)}$ / $\frac{-0.000}{(-0.00)}$	NONE	$\frac{.093 + .003}{(2.36 + 0.08)}$ / $\frac{-0.000}{(-0.00)}$	$\frac{.093 + .003}{(2.36 + 0.08)}$ / $\frac{-0.000}{(-0.00)}$	1.661 (42.19)	.140 (3.56)	.035 (0.89)	.102 (2.59)	.985 (25.02)	.128 (3.25)	.265 (6.73)	.425 (10.79)									OPTION A
71251-0019	BLACK	5.0 VOLT STD DRAM	CENTER	OFFSET LEFT	NONE	$\frac{.093 + .003}{(2.36 + 0.08)}$ / $\frac{-0.000}{(-0.00)}$	$\frac{.093 + .003}{(2.36 + 0.08)}$ / $\frac{-0.000}{(-0.00)}$	NONE	1.700 (43.18)	.155 (3.94)	.020 (0.51)	.127 (3.23)	.970 (24.64)	.113 (2.87)	.250 (6.35)	.410 (10.41)									OPTION B
71251-0020	BLACK	3.3 VOLT STD DRAM	CENTER	CENTER	$\frac{.080 \pm .002}{(2.03 \pm 0.05)}$	NONE	$\frac{.080 \pm .002}{(2.03 \pm 0.05)}$	$\frac{.080 \pm .002}{(2.03 \pm 0.05)}$	1.700 (43.18)	.140 (3.56)	.020 (0.51)	.127 (3.23)	.970 (24.64)	.113 (2.87)	.250 (6.35)	.410 (10.41)									OPTION B
71251-0021	BLACK	3.3 VOLT STD DRAM	CENTER	CENTER	$\frac{.080 \pm .002}{(2.03 \pm 0.05)}$	NONE	$\frac{.093 + .003}{(2.36 + 0.08)}$ / $\frac{-0.000}{(-0.00)}$	$\frac{.093 + .003}{(2.36 + 0.08)}$ / $\frac{-0.000}{(-0.00)}$	1.700 (43.18)	.155 (3.94)	.020 (0.51)	.127 (3.23)	.970 (24.64)	.113 (2.87)	.250 (6.35)	.410 (10.41)									OPTION B
71251-0022	BLACK	3.3 VOLT UNBUFFERED	OFFSET RIGHT	CENTER	$\frac{.080 \pm .002}{(2.03 \pm 0.05)}$	NONE	$\frac{.093 + .003}{(2.36 + 0.08)}$ / $\frac{-0.000}{(-0.00)}$	$\frac{.093 + .003}{(2.36 + 0.08)}$ / $\frac{-0.000}{(-0.00)}$	1.661 (42.19)	.155 (3.94)	.020 (0.51)	.127 (3.23)	.970 (24.64)	.113 (2.87)	.250 (6.35)	.410 (10.41)									OPTION B
71251-0023	BLACK	3.3 VOLT UNBUFFERED	OFFSET RIGHT	CENTER	$\frac{.080 \pm .002}{(2.03 \pm 0.05)}$	NONE	NONE	$\frac{.080 \pm .002}{(2.03 \pm 0.05)}$	1.661 (42.19)	.125 (3.18)	.035 (0.89)	.102 (2.59)	.985 (25.02)	.128 (3.25)	.265 (6.73)	.425 (10.79)									OPTION A
71251-0024	BLACK	3.3 VOLT UNBUFFERED	OFFSET RIGHT	CENTER	$\frac{.080 \pm .002}{(2.03 \pm 0.05)}$	NONE	$\frac{.093 + .003}{(2.36 + 0.08)}$ / $\frac{-0.000}{(-0.00)}$	$\frac{.093 + .003}{(2.36 + 0.08)}$ / $\frac{-0.000}{(-0.00)}$	1.661 (42.19)	.155 (3.94)	.020 (0.51)	.105 (2.67)	.970 (24.64)	.113 (2.87)	.250 (6.35)	.410 (10.41)									OPTION A
71251-0026	BEIGE	3.3 VOLT STD DRAM	CENTER	CENTER	$\frac{.080 \pm .002}{(2.03 \pm 0.05)}$	NONE	NONE	$\frac{.080 \pm .002}{(2.03 \pm 0.05)}$	1.700 (43.18)	.125 (3.18)	.035 (0.89)	.090 (2.29)	.985 (25.02)	.128 (3.25)	.265 (6.73)	.425 (10.79)									OPTION A
71251-0027	BLACK	3.3 VOLT SYNCHRONOUS	OFFSET LEFT	CENTER	NONE	$\frac{.093 + .003}{(2.36 + 0.08)}$ / $\frac{-0.000}{(-0.00)}$	$\frac{.093 + .003}{(2.36 + 0.08)}$ / $\frac{-0.000}{(-0.00)}$	NONE	1.739 (44.17)	.155 (3.94)	.020 (0.51)	.127 (3.23)	.970 (24.64)	.113 (2.87)	.250 (6.35)	.410 (10.41)									OPTION A

										DIMENSIONS SHOWN (METRIC) INCH UNLESS OTHERWISE SPECIFIED TOLERANCES ANGULAR ± 1/2°										REVISE ONLY ON CAD SYSTEM									
										INCH METRIC										TITLE .050/(1.27) PITCH MULTI-KEY 168 CKT DIMM RAM ASSY 17.8mm LATCH SALES DWG.									
										3 PLACE ± .005 ---										PART NO. 71251-0001									
										2 PLACE ± .01 ± 0.13										MOLEX INCORPORATED SHEET NO. 3 DATE 12/07/95									
										1 PLACE --- ± 0.25										L15LEJLL U.S.A. 60532									
										DRAFT WHERE APPLICABLE MUST REMAIN WITHIN DIMENSIONS										SEE CHART SDA-71251-0...									
										H SEE SHEET 1										DRWG. NO. DCB									
										F3 SEE SHEET 1										CHK'D BY DCB									
										LTR. REVISIONS										FILE NAME ST 05103									
										LTR. REVISIONS										SCALE 2: 1									
																				THIS DRAWING CONTAINS INFORMATION THAT IS PROPRIETARY TO MOLEX INC. AND SHOULD NOT BE USED WITHOUT WRITTEN PERMISSION									