

Intelligent Power Module (R-Series)

Maximum Ratings and Characteristics

Absolute Maximum Ratings ($T_c=25^\circ\text{C}$)

Items	Symbols	Ratings		Units
		Min.	Max.	
DC Bus Voltage	V_{DC}	0	450	V
DC Bus Voltage (surge)	$V_{DC(Surge)}$	0	500	
DC Bus Voltage (short operating)	V_{SC}	200	400	
Collector-Emitter Voltage	V_{CES}	0	600	
Inverter Collector Current	Continuous	I_C	150	A
	1ms	I_{CP}	300	
	Duty=58.8%	$-I_C$	150	
Collector Power Dissipation (One Transistor)	P_C		595	W
Voltage of Power Supply for Driver	V_{CC}^*1	0	20	V
Input Signal Voltage	V_{IN}^*2	0	V_Z	V
Input Signal Current	I_{IN}		1	mA
Alarm Signal Voltage	V_{ALM}^*3	0	V_{CC}	V
Alarm Signal Current	I_{ALM}^*4		15	mA
Junction Temperature	T_J		150	°C
Operating Temperature	T_{OP}	-20	100	
Storage Temperature	T_{stg}	-40	125	
Isolation Voltage	A.C. 1min. V_{iso}		2500	
Screw Torque	Mounting *1		3.5	Nm
	Terminals *1		3.5	

Note: *1 : Recommendable Value; 2.5 – 3.0 Nm (M5)

Outline Drawing

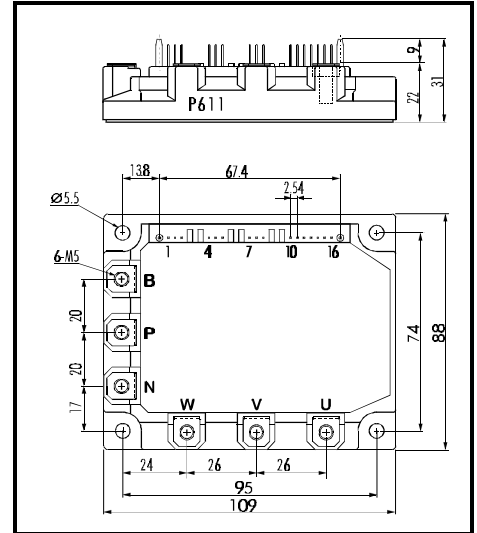

Fig. 1

Electrical Characteristics of Power Circuit (at $T_J=25^\circ\text{C}$, $V_{CC}=15\text{V}$)

Items	Symbols	Conditions	Min.	Typ.	Max.	Units
INV	Collector Current At Off Signal Input	I_{CES}	$V_{CE}=600\text{V}$, Input Terminal Open		1.0	mA
	Collector-Emitter Saturation Voltage	$V_{CE(Sat)}$	$I_C=150\text{A}$		2.8	V
	Forward Voltage of FWD	V_F	$-I_C=150\text{A}$		3.0	V

Electrical Characteristics of Control Circuit (at $T_J=25^\circ\text{C}$, $V_{CC}=15\text{V}$)

Items	Symbols	Conditions	Min.	Typ.	Max.	Units
Current of P-Line Side Driver (One Unit)	I_{CCP}	$f_{SW}=0\sim 15\text{kHz}$, $T_C=-20\sim 100^\circ\text{C}$	3		18	mA
Current of N-Line Side Driver (Three Units)	I_{CCN}	$f_{SW}=0\sim 15\text{kHz}$, $T_C=-20\sim 100^\circ\text{C}$	10		65	
Input Signal Threshold Voltage	$V_{IN(th)}$	On	1.00	1.35	1.70	V
		Off	1.25	1.60	1.95	
Input Zener Voltage	V_Z	$R_{IN}=20\text{k}\Omega$		8.0		
Over Heating Protection Temperature Level	T_{COH}	$V_{DC}=0\text{V}$, $I_C=0\text{A}$, Case Temp.	110		125	°C
Hysteresis	T_{CH}			20		
IGBT Chips Over Heating Protec. Temp. Level	T_{IOH}	Surface of IGBT Chip	150			
Hysteresis	T_{IH}			20		
Inverter Collector Current Protection Level	I_{OC}	$T_J=125^\circ\text{C}$	225			A
Over Current Detecting Time	t_{DOC}	$T_J=25^\circ\text{C}$		10		μs
Alarm Signal Hold Time	t_{ALM}		1.5	2		ms
Limiting Resistor for Alarm	R_{ALM}		1425	1500	1575	Ω
Under Voltage Protection Level	V_{UV}		11.0		12.5	V
Hysteresis	V_H		0.2			

Dynamic Characteristics (at $T_C=T_J=125^\circ\text{C}$, $V_{CC}=15\text{V}$)

Items	Symbols	Conditions	Min.	Typ.	Max.	Units
Switching Time	t_{ON}	$I_C=150\text{A}$, $V_{DC}=300\text{V}$	0.3			μs
	t_{OFF}				3.6	
	t_{RR}	$I_F=150\text{A}$, $V_{DC}=300\text{V}$			0.4	

Thermal Characteristics

Items	Symbols	Conditions	Min.	Typ.	Max.	Units
Thermal Resistance	$R_{th(j-c)}$	Inverter IGBT			0.21	°C/W
	$R_{th(j-c)}$	Diode			0.47	
	$R_{th(c-f)}$	With Thermal Compound		0.05		

■ Equivalent Circuit

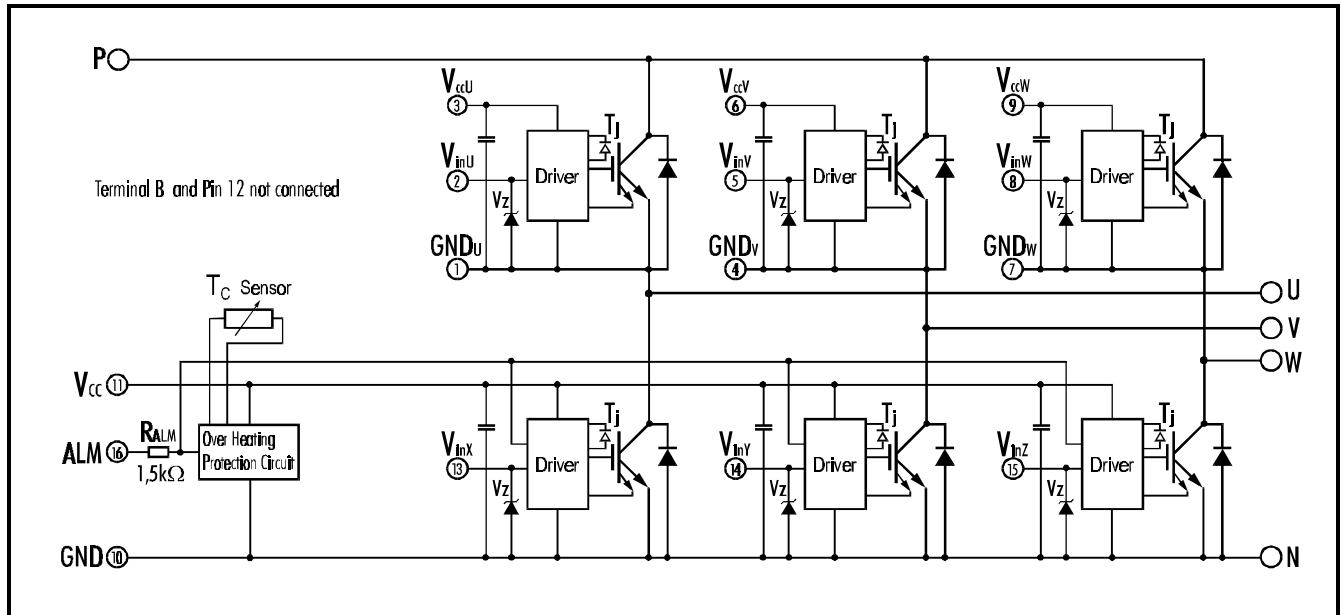

Drivers include following functions

- Short circuit protection circuit
- Amplifier for driver
- Undervoltage protection circuit
- Overcurrent protection circuit
- IGBT Chip overheating protection

Control Circuit

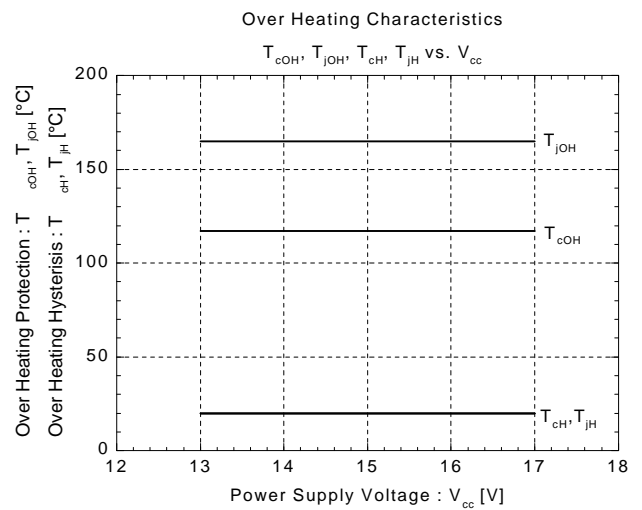
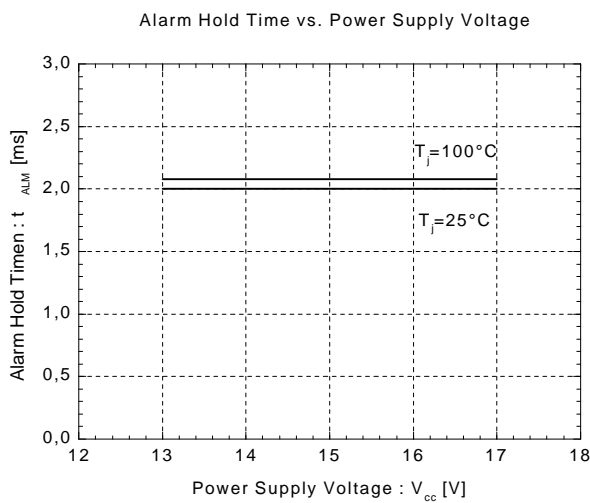
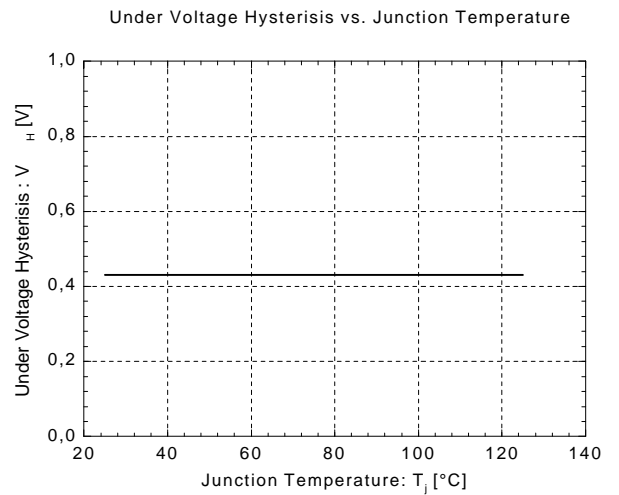
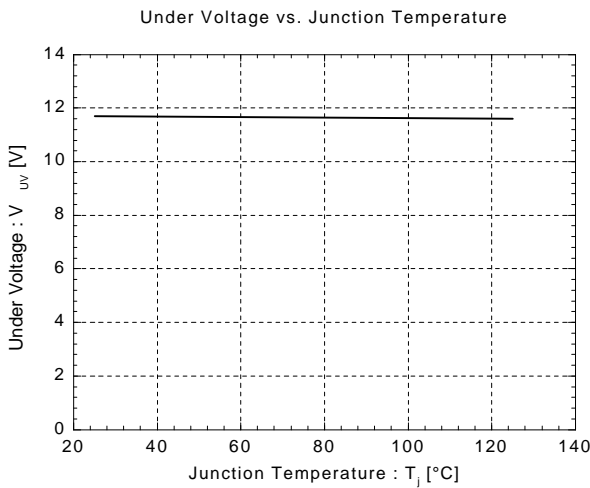
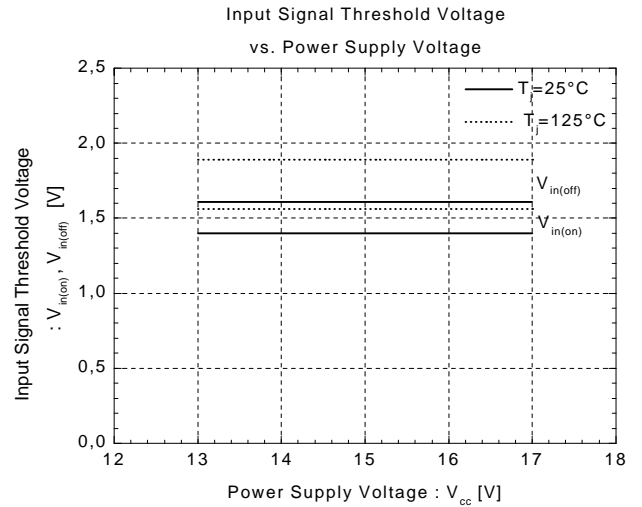
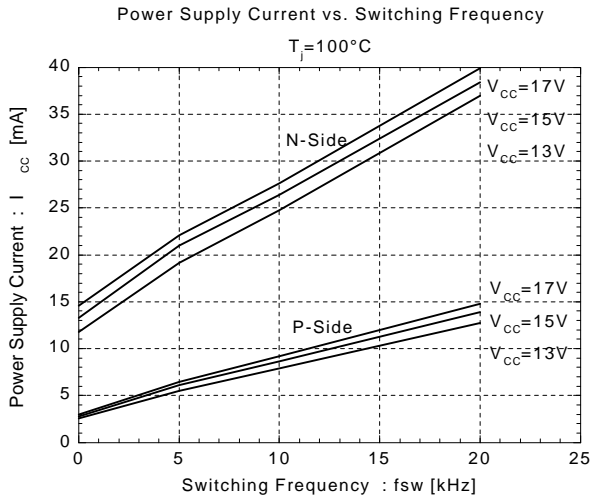

■ Inverter

Collector Current vs. Collector-Emitter Voltage

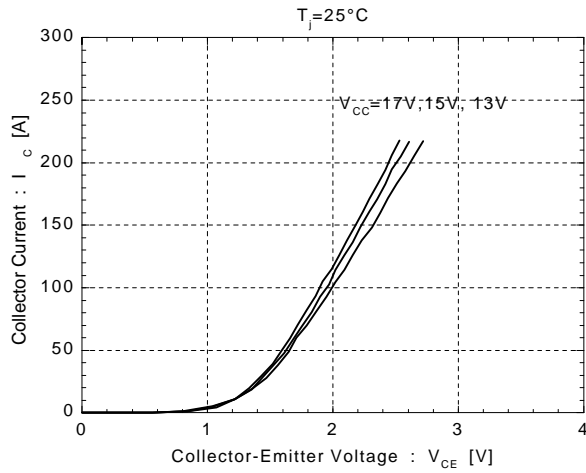

Collector Current vs. Collector-Emitter Voltage

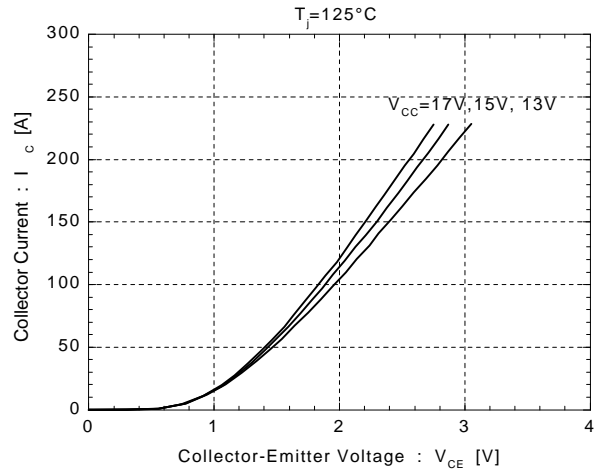

Switching Time vs. Collector Current

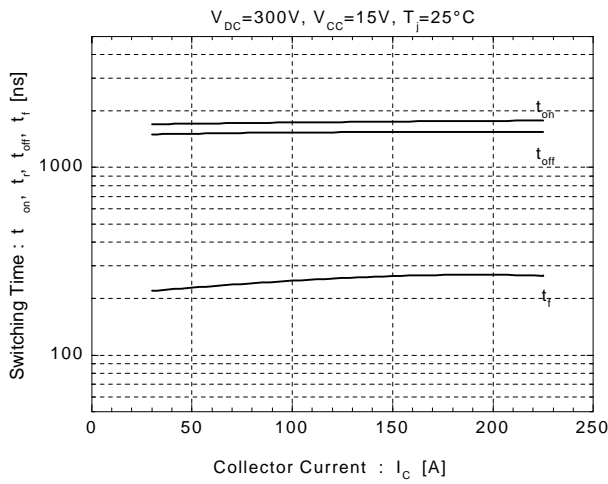

Switching Time vs. Collector Current

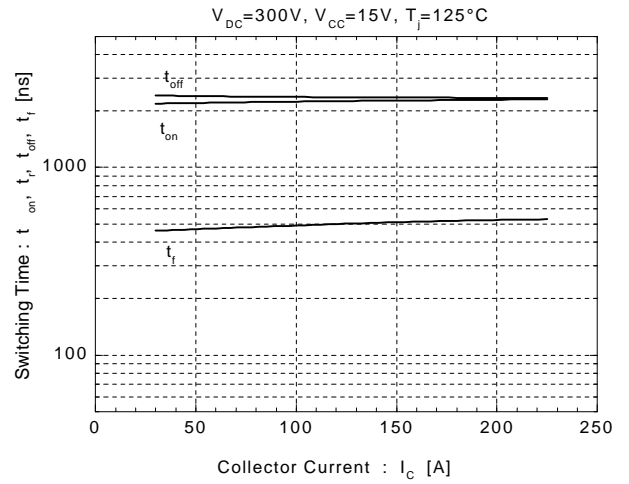

Forward Voltage vs. Forward Current

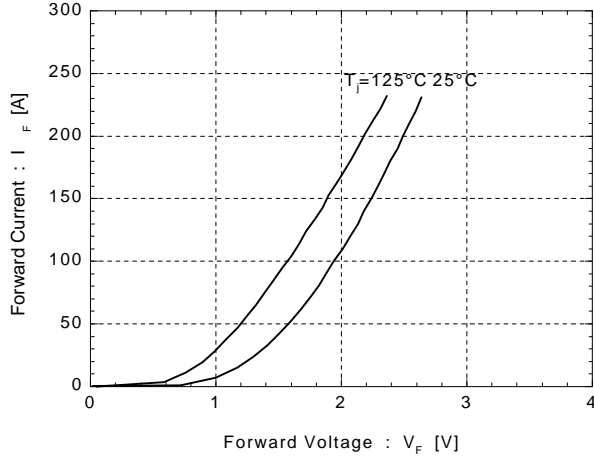

Reverse Recovery Characteristics

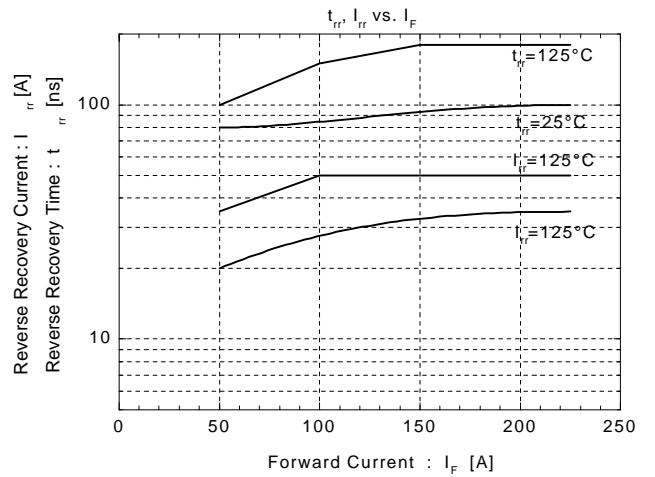

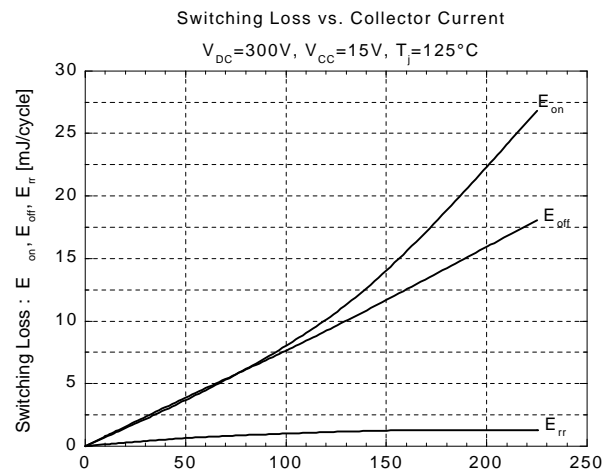
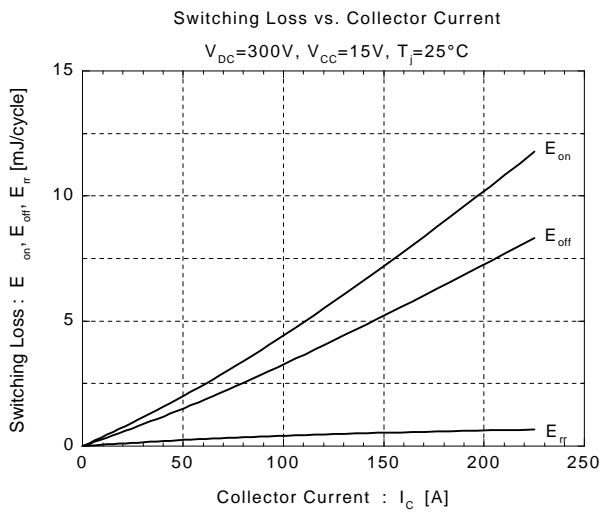
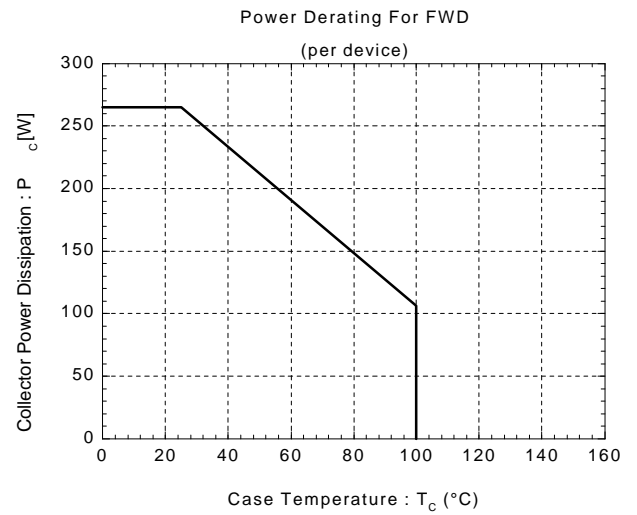
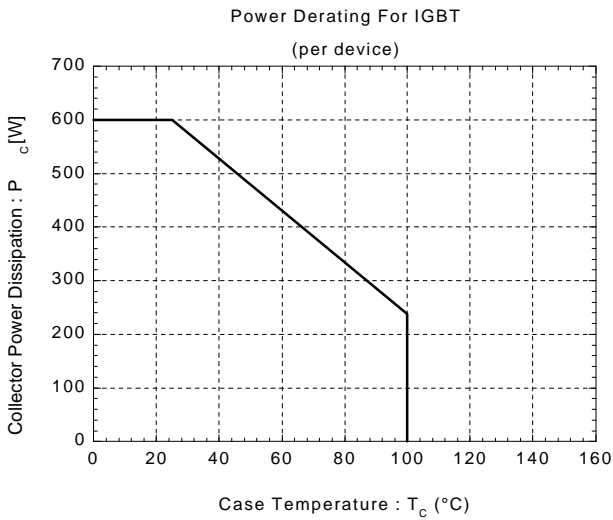
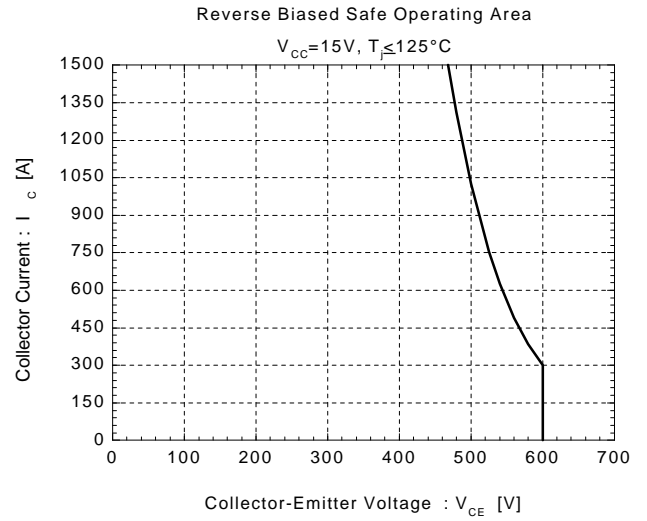
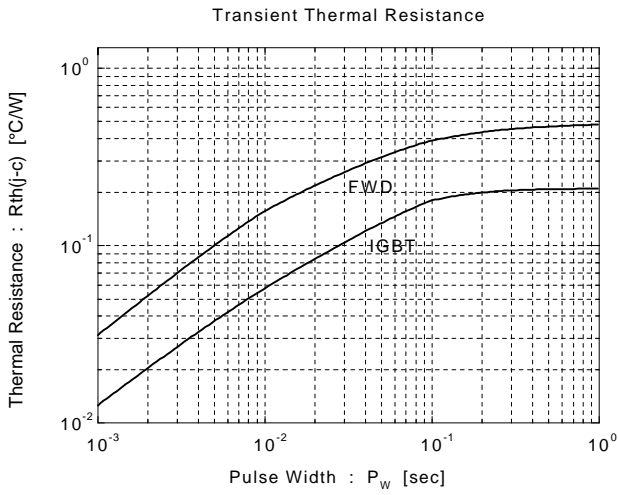

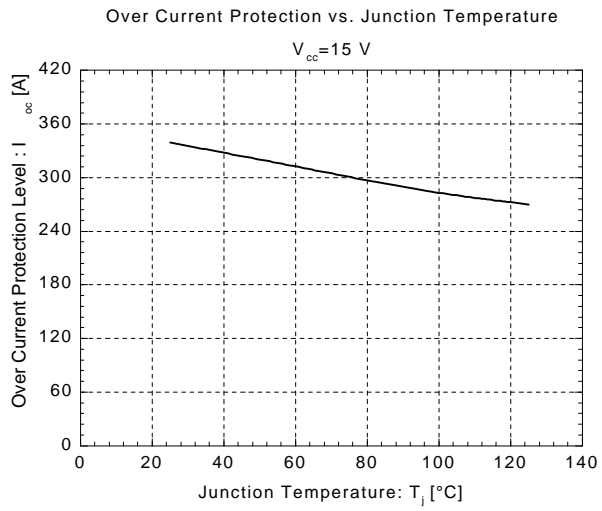

■ Outline Drawing

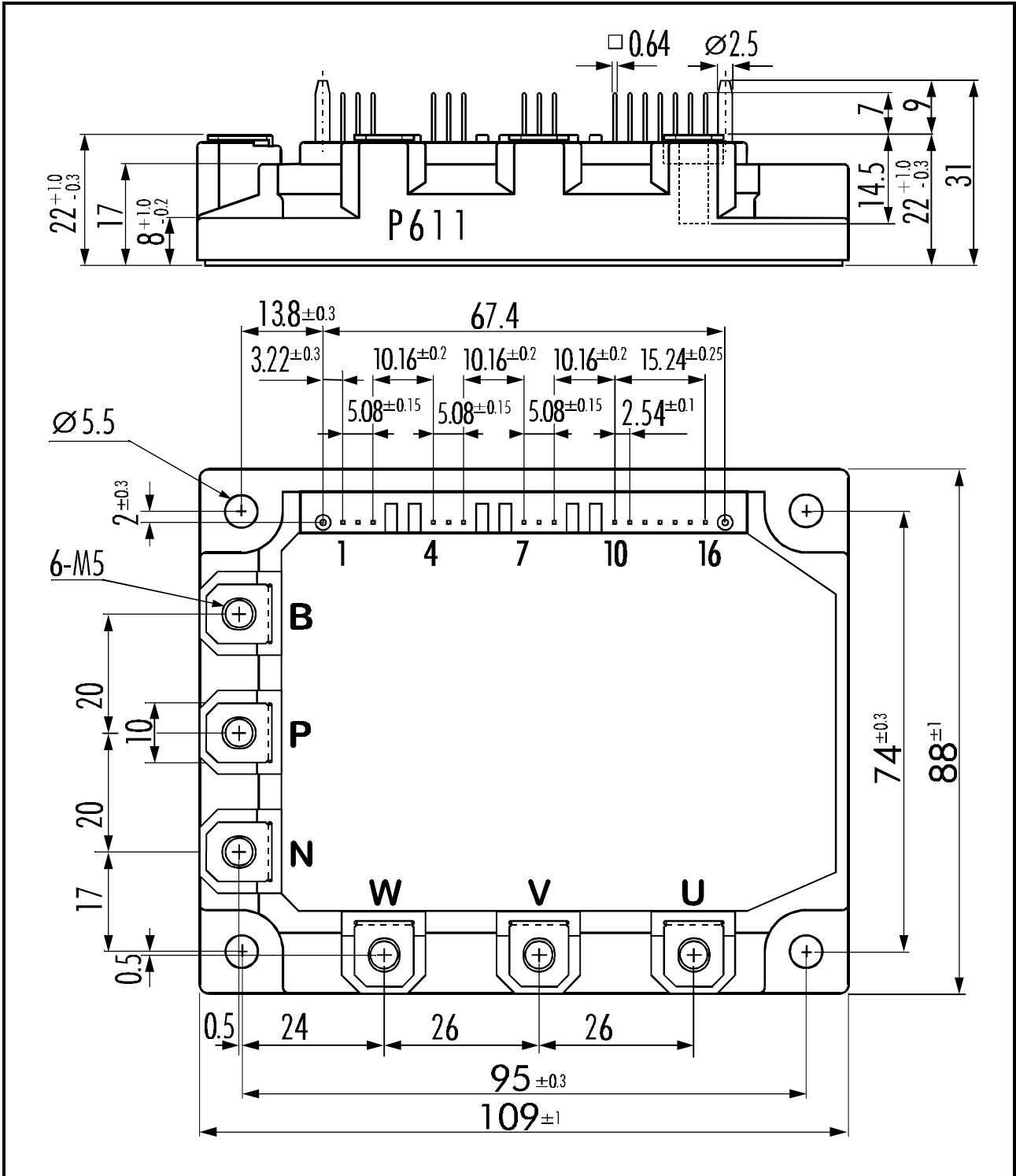

Weight: 440g