

### Features:

- High voltage capability from 1600V to 7000V
- Inexpensive high voltage leaded resistor solution
- High resistance values up to 500M
- Tolerances as low as 1%; TCRs as low as 50 ppm/°C
- Flameproof coating (brown) standard
- Epoxy coating (blue) available up to 2W
- MGE and MGME denote alternate epoxy coating instead of silicone
- 100% RoHS compliant and lead free without exemption
- Halogen free
- REACH compliant



Electrical Specifications							
Type/Code	Power Rating (W) @ 70°C	Maximum Working Voltage (V)	Maximum Overload Voltage (V)	Dielectric Withstanding Voltage (V)		TCR (ppm/°C) <sup>(1)</sup>	Ohmic Range (Ω) and Tolerance
				Silicone	Epoxy		
MG14	0.25	1600	2000	400	500	± 100	100K - 500M
MG12	0.5	3500	4000	500	700		
MG1	1	4500	5000	500	1000		
MG2	2	7000	14000	700	1200		
MGM12	0.5	1700	2500	400	500		
MGM1	1	4000	4500	500	700		
MGM2	2	5000	10000	500	1000		
MGM3	3	7000	14000	700	1200		

(1) ±50 ppm/°C available for some values and sizes. Contact Stackpole.

Mechanical Specifications					
Type/Code	A Body Length	B Body Diameter	C Lead Length (Bulk)	D Lead Diameter	Unit
MG14	0.248 ± 0.020	0.091 ± 0.012	1.102 ± 0.079	0.022 ± 0.001	inches
	6.30 ± 0.50	2.30 ± 0.30	28.00 ± 2.00	0.55 ± 0.03	mm
MG12	0.354 ± 0.020	0.126 ± 0.020	1.024 ± 0.079	0.026 ± 0.001	inches
	9.00 ± 0.50	3.20 ± 0.50	26.00 ± 2.00	0.65 ± 0.03	mm
MG1	0.453 ± 0.039	0.157 ± 0.020	0.945 ± 0.079	0.031 ± 0.001	inches
	11.50 ± 1.00	4.00 ± 0.50	24.00 ± 2.00	0.78 ± 0.03	mm
MG2	0.610 ± 0.039	0.197 ± 0.020	1.260 ± 0.079	0.031 ± 0.001	inches
	15.50 ± 1.00	5.00 ± 0.50	32.00 ± 2.00	0.78 ± 0.03	mm
MGM12	0.248 ± 0.020	0.091 ± 0.012	1.102 ± 0.079	0.022 ± 0.001	inches
	6.30 ± 0.50	2.30 ± 0.30	28.00 ± 2.00	0.55 ± 0.03	mm
MGM1	0.354 ± 0.020	0.157 ± 0.020	1.024 ± 0.079	0.026 ± 0.001	inches
	9.00 ± 0.50	4.00 ± 0.50	26.00 ± 2.00	0.65 ± 0.03	mm
MGM2	0.453 ± 0.039	0.177 ± 0.020	1.378 ± 0.079	0.031 ± 0.001	inches
	11.50 ± 1.00	4.50 ± 0.50	35.00 ± 2.00	0.78 ± 0.03	mm
MGM3	0.610 ± 0.039	0.197 ± 0.020	1.260 ± 0.079	0.031 ± 0.001	inches
	15.50 ± 1.00	5.00 ± 0.50	32.00 ± 2.00	0.78 ± 0.03	mm

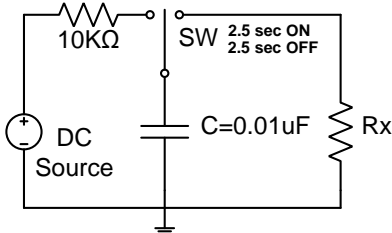
Performance Characteristics		
Test	Test Specification	Test Condition
Temperature Coefficient (TCR)	by type (see Electrical Specification Chart)	Resistance value at room temperature
Short Time Overload	$\pm(1\% + 0.05\Omega)$	Rated Voltage x 2.5 or Max. Overload Voltage, whichever is lower, for 5 seconds
Moisture Resistance	$\pm(5\% + 0.05\Omega)$	40°C $\pm$ 2°C, 90% ~ 95% R.H., 1000 hours (for epoxy resin) 90 minutes ON and 30 minutes OFF
Load Life	$\pm(3\% + 0.05\Omega)$	1000 hours at rated voltage, 70°C 90 minutes ON and 30 minutes OFF
Insulation Resistance	$\pm 10,000 \text{ M}\Omega$ over	500 $\pm$ 50V DC during 1 minute, V-Block method
Dielectric Withstanding Voltage	by type (see Electrical Specification Chart)	In V-Block for 60 seconds
Resistance to Soldering Heat	$\pm(1\% + 0.05\Omega)$	260°C $\pm$ 5°C, 2 seconds $\pm$ 1 second
Resistance to Solvent	No abnormality in coatings and markings	IPA for 5 $\pm$ 0.5 minutes with ultrasonic
Terminal Strength	Tensile: $\geq 2.5 \text{ Kg}$	Direct load for 10 seconds, in the direction of the terminal leads
Anti-surge Characteristics	$\pm(10\% + 0.05\Omega)$	Discharge Test: 0.01uF capacitor discharge pulse 10 times (1 pulse / 5 seconds max.) 
Intermittent Overload	$\pm(1\% + 0.05\Omega)$	4 times RCWV for 10000 cycles (1 second ON, 25 seconds OFF)

$RCWV \text{ (Rated Continuous Working Voltage)} = \sqrt{P \cdot R}$

Operating Temperature Range: -55°C to +175°C

**Power Derating Curve:**

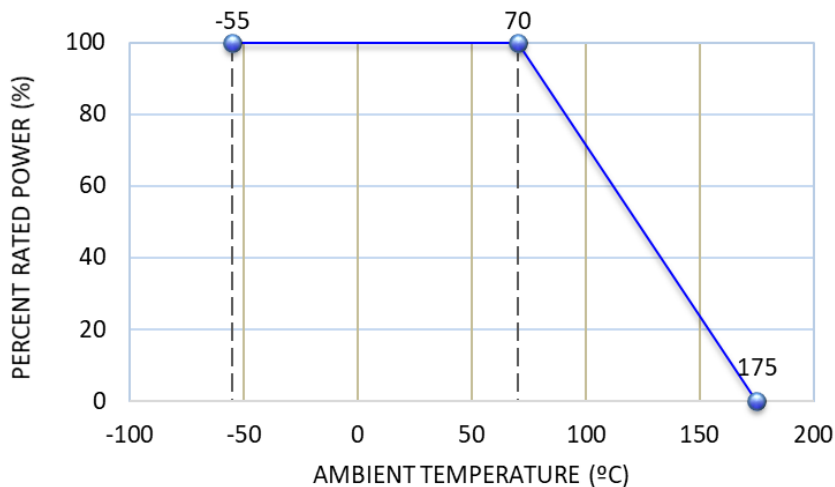

**Temperature Rise:**

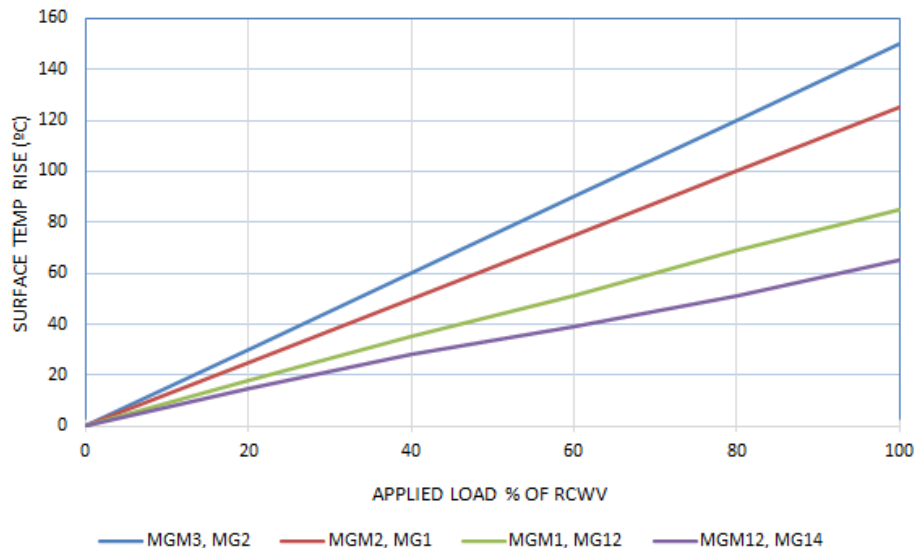

**Recommended Solder Profile**

This information is intended as a reference for solder profiles for Stackpole resistive components. These profiles should be compatible with most soldering processes. These are only recommendations. Actual numbers will depend on board density, geometry, packages used, etc., especially those cells labeled with “\*”.

**100% Matte Tin / RoHS Compliant Terminations**

Soldering iron recommended temperatures: 330°C to 350°C with minimum duration.  
 Maximum number of reflow cycles: 3.

Wave Soldering			
Description	Maximum	Recommended	Minimum
Preheat Time	80 seconds	70 seconds	60 seconds
Temperature Diff.	140°C	120°C	100°C
Solder Temp.	260°C	250°C	240°C
Dwell Time at Max.	10 seconds	5 seconds	*
Ramp DN (°C/sec)	N/A	N/A	N/A

Temperature Diff. = Difference between final preheat stage and soldering stage.

Convection IR Reflow			
Description	Maximum	Recommended	Minimum
Ramp Up (°C/sec)	3°C/sec	2°C/sec	*
Dwell Time > 217°C	150 seconds	90 seconds	60 seconds
Solder Temp.	260°C	245°C	*
Dwell Time at Max.	30 seconds	15 seconds	10 seconds
Ramp DN (°C/sec)	6°C/sec	3°C/sec	*

**Recommended Lead Free Resistor Reflow Profile**

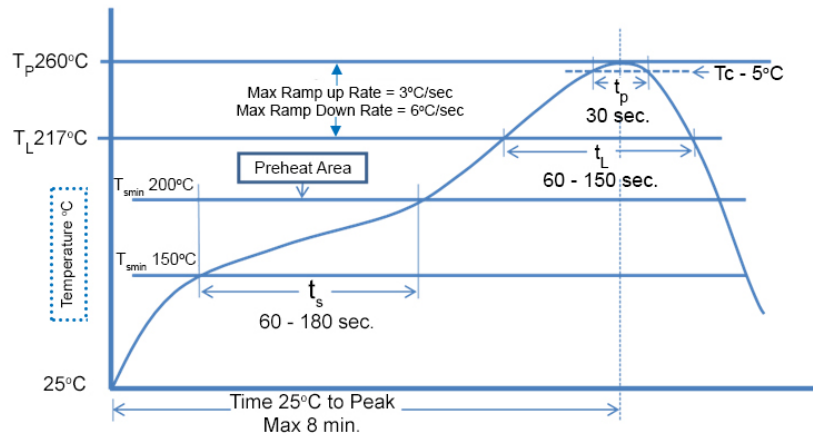

**Packaging Specifications**

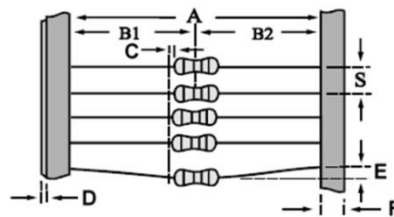

Type/Code	A	B1/B2	C	D	E	F	S	Unit
MG14	2.047 +0.039 /-0.00 52.00 +1.00 /-0.00	0.047 1.20	0.031 max. 0.80 max.	0.020 max. 0.50 max.	0.047 max. 1.20 max.	0.236 ± 0.020 6.00 ± 0.50	0.197 5.00	inches mm
MG12	2.047 +0.039 /-0.00 52.00 +1.00 /-0.00	0.047 1.20	0.031 max. 0.80 max.	0.020 max. 0.50 max.	0.047 max. 1.20 max.	0.236 ± 0.020 6.00 ± 0.50	0.197 5.00	inches mm
MG1	2.874 +0.039 /-0.00 73.00 +1.00 /-0.00	0.059 1.50	0.031 max. 0.80 max.	0.020 max. 0.50 max.	0.047 max. 1.20 max.	0.236 ± 0.020 6.00 ± 0.50	0.197 5.00	inches mm
MG2	2.874 +0.039 /-0.00 73.00 +1.00 /-0.00	0.059 1.50	0.031 max. 0.80 max.	0.020 max. 0.50 max.	0.047 max. 1.20 max.	0.236 ± 0.020 6.00 ± 0.50	0.394 10.00	inches mm
MGM12	2.047 +0.039 /-0.00 52.00 +1.00 /-0.00	0.047 1.20	0.031 max. 0.80 max.	0.020 max. 0.50 max.	0.047 max. 1.20 max.	0.236 ± 0.020 6.00 ± 0.50	0.197 5.00	inches mm
MGM1	2.047 +0.039 /-0.00 52.00 +1.00 /-0.00	0.047 1.20	0.031 max. 0.80 max.	0.020 max. 0.50 max.	0.047 max. 1.20 max.	0.236 ± 0.020 6.00 ± 0.50	0.197 5.00	inches mm
MGM2	2.874 +0.039 /-0.00 73.00 +1.00 /-0.00	0.059 1.50	0.031 max. 0.80 max.	0.020 max. 0.50 max.	0.047 max. 1.20 max.	0.236 ± 0.020 6.00 ± 0.50	0.197 5.00	inches mm
MGM3	2.874 +0.039 /-0.00 73.00 +1.00 /-0.00	0.059 1.50	0.031 max. 0.80 max.	0.020 max. 0.50 max.	0.047 max. 1.20 max.	0.236 ± 0.020 6.00 ± 0.50	0.394 10.00	inches mm

Max. deviation of spacing: 1mm per 10 spacing.

**Tape on Reel/Tape on Box Specifications**

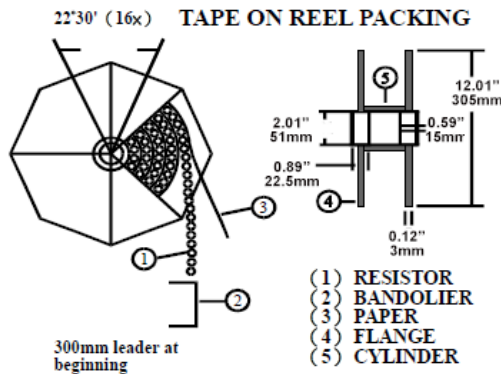

**TAPE ON BOX PACKING**

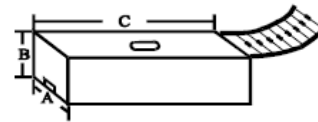

Type/Code	Quantity per Reel	Quantity per Box	Tape on Reel		Tape on Box			Unit
			Across Flange (A)	W (A)	H (B)	L (C)		
MG14	5000	5000	2.835	3.150	2.953	10.394	inches	
			72.00	80.00	75.00	264.00	mm	
MG12	3000	1000	2.835	3.150	1.811	10.394	inches	
			72.00	80.00	46.00	264.00	mm	
MG1	2000	1000	2.835	3.150	2.953	10.394	inches	
			72.00	80.00	75.00	264.00	mm	
MG2	1000	1000	3.740	4.055	3.780	10.433	inches	
			95.00	103.00	96.00	265.00	mm	
MGM12	5000	5000	2.835	3.150	4.134	10.394	inches	
			72.00	80.00	105.00	264.00	mm	
MGM1	3000	1000	2.835	3.150	1.811	10.394	inches	
			72.00	80.00	46.00	264.00	mm	
MGM2	2000	1000	3.740	4.055	3.228	10.433	inches	
			95.00	103.00	82.00	265.00	mm	
MGM3	1000	1000	3.740	4.055	3.780	10.433	inches	
			95.00	103.00	96.00	265.00	mm	

**RoHS Compliance**

Stackpole Electronics has joined the worldwide effort to reduce the amount of lead in electronic components and to meet the various regulatory requirements now prevalent, such as the European Union’s directive regarding “Restrictions on Hazardous Substances” (RoHS 3). As part of this ongoing program, we periodically update this document with the status regarding the availability of our compliant components. All our standard part numbers are compliant to EU Directive 2011/65/EU of the European Parliament as amended by Directive (EU) 2015/863/EU as regards the list of restricted substances.

**RoHS Compliance Status**

Standard Product Series	Description	Package / Termination Type	Standard Series RoHS Compliant	Lead-Free Termination Composition	Lead-Free Mfg. Effective Date (Std Product Series)	Lead-Free Effective Date Code (YY/WW)
MG	High Voltage Metal Glaze Leaded Resistor	Axial	YES <sup>(1)</sup>	100% Matte Sn	Jan-06	04/01
MGE	High Voltage Metal Glaze Leaded Resistor (Epoxy Coating)	Axial	YES <sup>(1)</sup>	100% Matte Sn	Jan-06	04/01
MGM	High Voltage Mini Metal Glaze Leaded Resistor	Axial	YES <sup>(1)</sup>	100% Matte Sn	Always	Always
MGME	High Voltage Mini Metal Glaze Leaded Resistor (Epoxy Coating)	Axial	YES <sup>(1)</sup>	100% Matte Sn	Always	Always

### “Conflict Metals” Commitment

We at Stackpole Electronics, Inc. are joined with our industry in opposing the use of metals mined in the “conflict region” of the eastern Democratic Republic of the Congo (DRC) in our products. Recognizing that the supply chain for metals used in the electronics industry is very complex, we work closely with our own suppliers to verify to the extent possible that the materials and products we supply do not contain metals sourced from this conflict region. As such, we are in compliance with the requirements of Dodd-Frank Act regarding Conflict Minerals.

### Compliance to “REACH”

We certify that all passive components supplied by Stackpole Electronics, Inc. are SVHC (Substances of Very High Concern) free and compliant with the requirements of EU Directive 1907/2006/EC, “The Registration, Evaluation, Authorization and Restriction of Chemicals”, otherwise referred to as REACH. Contact us for complete list of REACH Substance Candidate List.

### Environmental Policy

It is the policy of Stackpole Electronics, Inc. (SEI) to protect the environment in all localities in which we operate. We continually strive to improve our effect on the environment. We observe all applicable laws and regulations regarding the protection of our environment and all requests related to the environment to which we have agreed. We are committed to the prevention of all forms of pollution.

## How to Order

