



PRODUCT SPECIFICATION

Model No : CSM-88160SG

Descriptions:

- 1.2 Inch 8X8 Dot-Matrix Display
- Dot Pitch 4.0mm
- CSM-58161: Column Cathode, Row Anode
- Emitting Color: Super Bright Red & Yellow Green



CUSTOMER APPROVED SIGNATURES	APPROVED BY	CHECKED BY	PREPARED BY

CHINA SEMICONDUCTOR CORPORATION

Address:2FL. NO.909,Chung-Cheng Road,
Chung-Ho City Taipei Hsien,Taiwan.

Tel:886-2-2223-9696
Fax:886-2-2223-9377

OPTO PLUS TECHNOLOGIES CO.,LTD

Address:696 Shun jiang Rd.,Ji Shan St.Shaoxing,
ZheJiang,China

Tel:86-0575-88623888
Fax:86-0575-88623112



Spec. No.	PS-ND-08090403
Rev.	A

Model No : CSM-88160SG

Features -

1. 1.2 inch (31.0mm) Matrix height.
2. Case mold type.
3. RoHS compliant.
4. Low power consumption.
5. Easy mounting on P.C. board or socket.

Device Selection Guide -

Part No.	Chip		Column	Row
	Material	Emitted Color		
CSM-88160SG	AlGaAs	Super Bright Red	Cathode	Anode
	GaP	Yellow Green		

Package Dimensions -

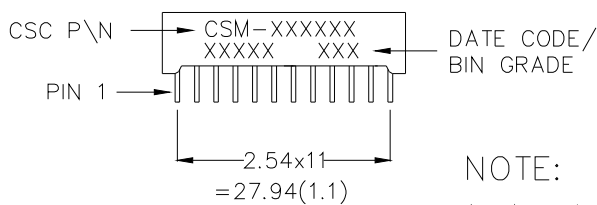
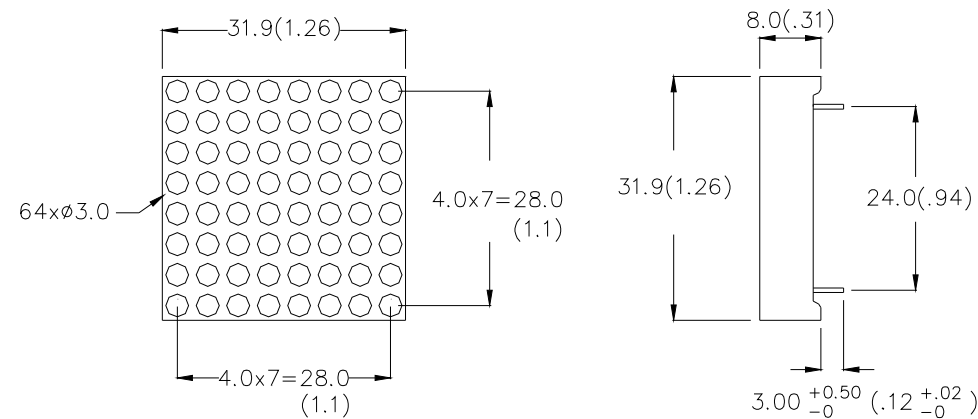

NOTE:

1. All pins are $\phi 0.5(.02)$.
2. Dimension in millimeter (inch), and tolerance is $\pm 0.25 (.01)$ unless otherwise noted.



Model No : CSM-88160SG

Internal Circuit Diagrams -

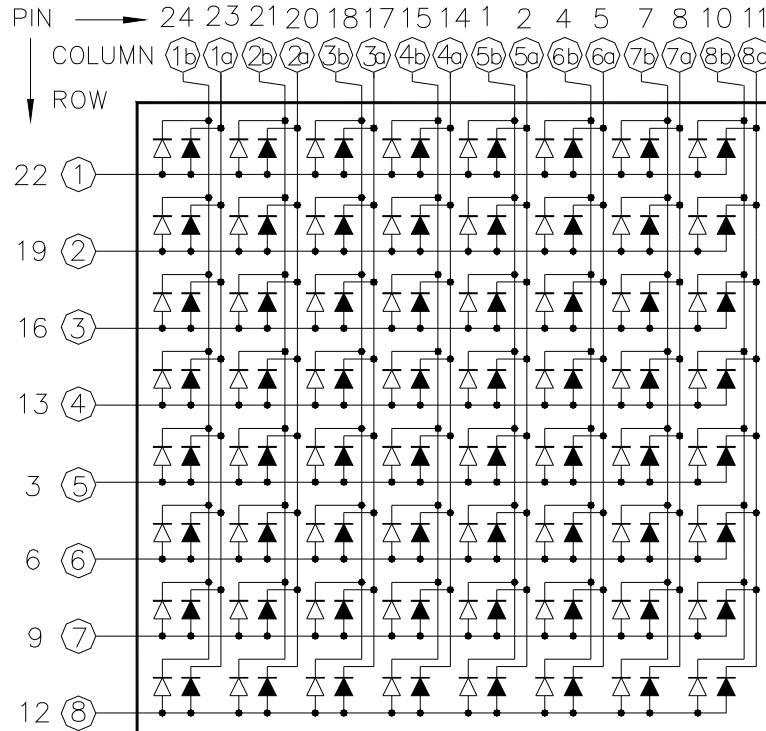

→ "a" for Super Bright Red color chip.

→ "b" for Yellow Green color chip.

Absolute Maximum Rating -

Super Bright Red		(Ta=25°C)	
Parameter	Symbol	Rating	Unit
Power Dissipation Per Dice	P _{AD}	75	mW
Continuous Forward Current Per Dice	I _{AF}	30	mA
Peak Current Per Dice(duty cycle 1/10, 1kHz)	I _{PF}	120	mA
Derating Linear From 25°C Per Dice	-	0.42	mA/°C
Reverse Voltage Per Dice	V _R	5	V
Operating Temp.	T _{opr}	-35 ~ +85	°C
Storage Temp.	T _{stg}	-35 ~ +85	°C
Solder temperature 1/16 inch below seating plane for 3 seconds at 260°C			



Model No : CSM-88160SG

Yellow Green		(Ta=25°C)	
Parameter	Symbol	Rating	Unit
Power Dissipation Per Dice	P _{AD}	70	mW
Continuous Forward Current Per Dice	I _{AF}	25	mA
Peak Current Per Dice(duty cycle 1/10, 1kHz)	I _{PF}	90	mA
Derating Linear From 25°C Per Dice	-	0.33	mA/°C
Reverse Voltage Per Dice	V _R	5	V
Operating Temp.	T _{opr}	-35 ~ +85	°C
Storage Temp.	T _{stg}	-35 ~ +85	°C
Solder temperature 1/16 inch below seating plane for 3 seconds at 260°C			

■ Electro-optical Characteristics -

Super Bright Red		(Ta=25°C)				
Parameter	Symbol	Min.	Typ.	Max.	Unit	Condition
Forward Voltage Per Dot	V _F	-	1.8	2.5	V	I _F =20mA
Luminous Intensity Per Dot	I _v	-	6	-	mcd	I _F =10mA
Peak Emission Wavelength	λ _p	-	660	-	nm	I _F =20mA
Dominant Wavelength	λ _d	-	644	-	nm	I _F =20mA
Spectrum Radiation Bandwidth	Δλ	-	20	-	nm	I _F =20mA
Reverse Current	I _R	-	-	100	μA	V _R =5V
Luminous Intensity Matching Ratio	I _{V-m}	-	-	2:1	-	I _p =80mA 1/16Duty

Yellow Green		(Ta=25°C)				
Parameter	Symbol	Min.	Typ.	Max.	Unit	Condition
Forward Voltage Per Dot	V _F	-	2.1	2.8	V	I _F =20mA
Luminous Intensity Per Dot	I _v	-	5	-	mcd	I _F =10mA
Peak Emission Wavelength	λ _p	-	568	-	nm	I _F =20mA
Dominant Wavelength	λ _d	-	572	-	nm	I _F =20mA
Spectrum Radiation Bandwidth	Δλ	-	30	-	nm	I _F =20mA
Reverse Current	I _R	-	-	100	μA	V _R =5V
Luminous Intensity Matching Ratio	I _{V-m}	-	-	2:1	-	I _p =80mA 1/16Duty



Spec. No.	PS-ND-08090403
Rev.	A

Model No : CSM-88160SG

Typical Electrical / Optical Charateristics Curves -Super Bright Red

(Ta = 25°C Unless Otherwise Noted)

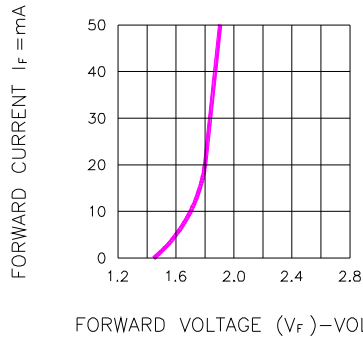

Fig.1 FORWARD CURRENT VS. FORWARD VOLTAGE

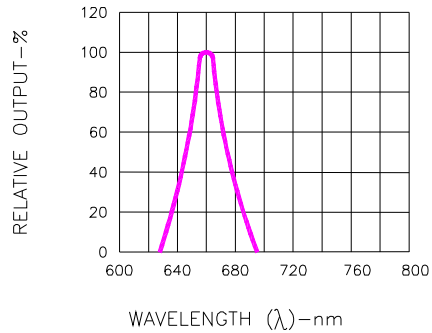

Fig.2 SPECTRAL RESPONSE

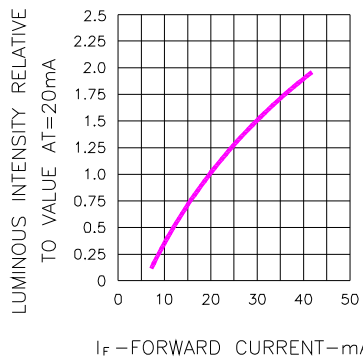

Fig.3 RELATIVE LUMINOUS INTENSITY VS. FORWARD CURRENT

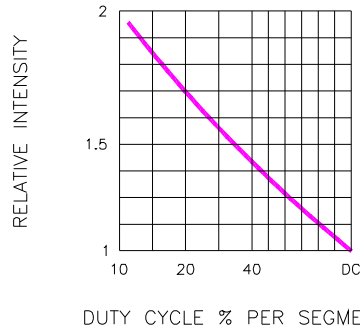

Fig.5 LUMINOUS INTENSITY VS. DUTY CYCLE

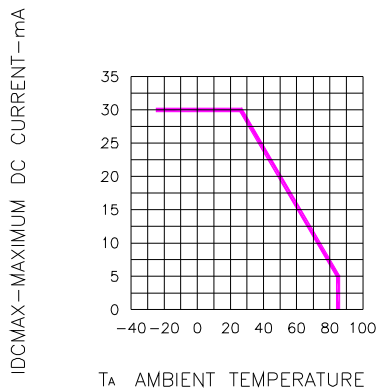

Fig.4 MAXIMUM ALLOWABLE DC CURRENT PER SEGMENT VS. A FUNCTION OF AMBIENT TEMPERATURE

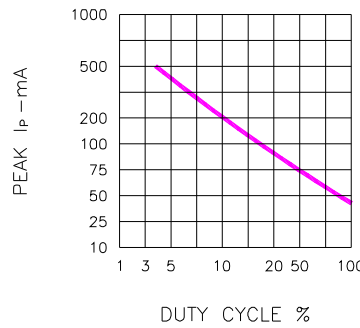

Fig.6 MAX PEAK CURRENT VS. DUTY CYCLE % (REFRESH RATE f=1 KHz)



Model No : CSM-88160SG

Yellow Green

(Ta = 25°C Unless Otherwise Noted)

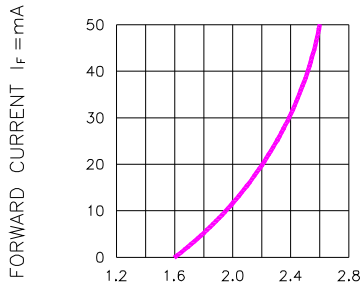

FORWARD VOLTAGE (V_F)—VOLTS
Fig.1 FORWARD CURRENT VS. FORWARD VOLTAGE

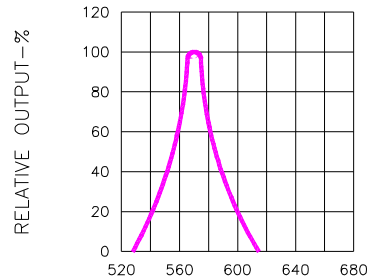

WAVELENGTH (λ)—nm
Fig.2 SPECTRAL RESPONSE

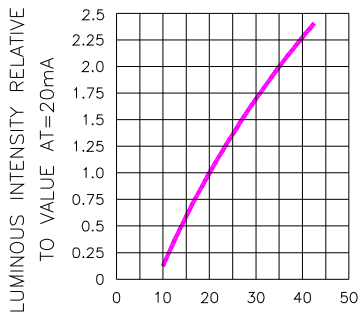

I_F—FORWARD CURRENT—mA
Fig.3 RELATIVE LUMINOUS INTENSITY VS. FORWARD CURRENT

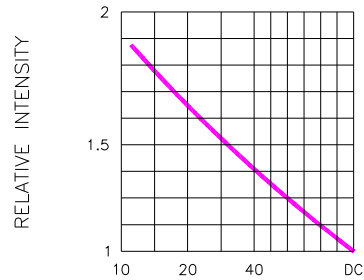

DUTY CYCLE % PER SEGMENT
(AVERAGE I_F=10mA)
Fig.5 LUMINOUS INTENSITY VS. DUTY CYCLE

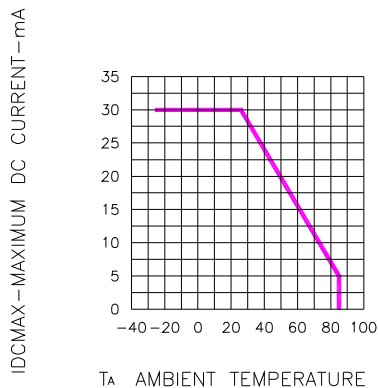

Fig.4 MAXIMUM ALLOWABLE DC CURRENT PER SEGMENT VS. A FUNCTION OF AMBIENT TEMPERATURE

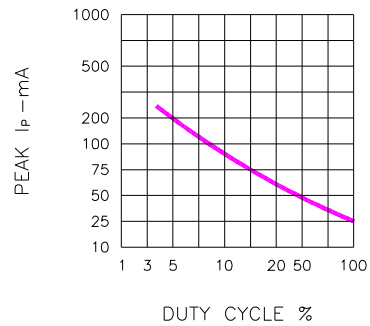

Fig.6 MAX PEAK CURRENT VS. DUTY CYCLE %
(REFRESH RATE f=1 KHz)





Spec. No.	PS-ND-0710
Rev.	A

Model No: CSM-88160SG

■ Package Dimensions

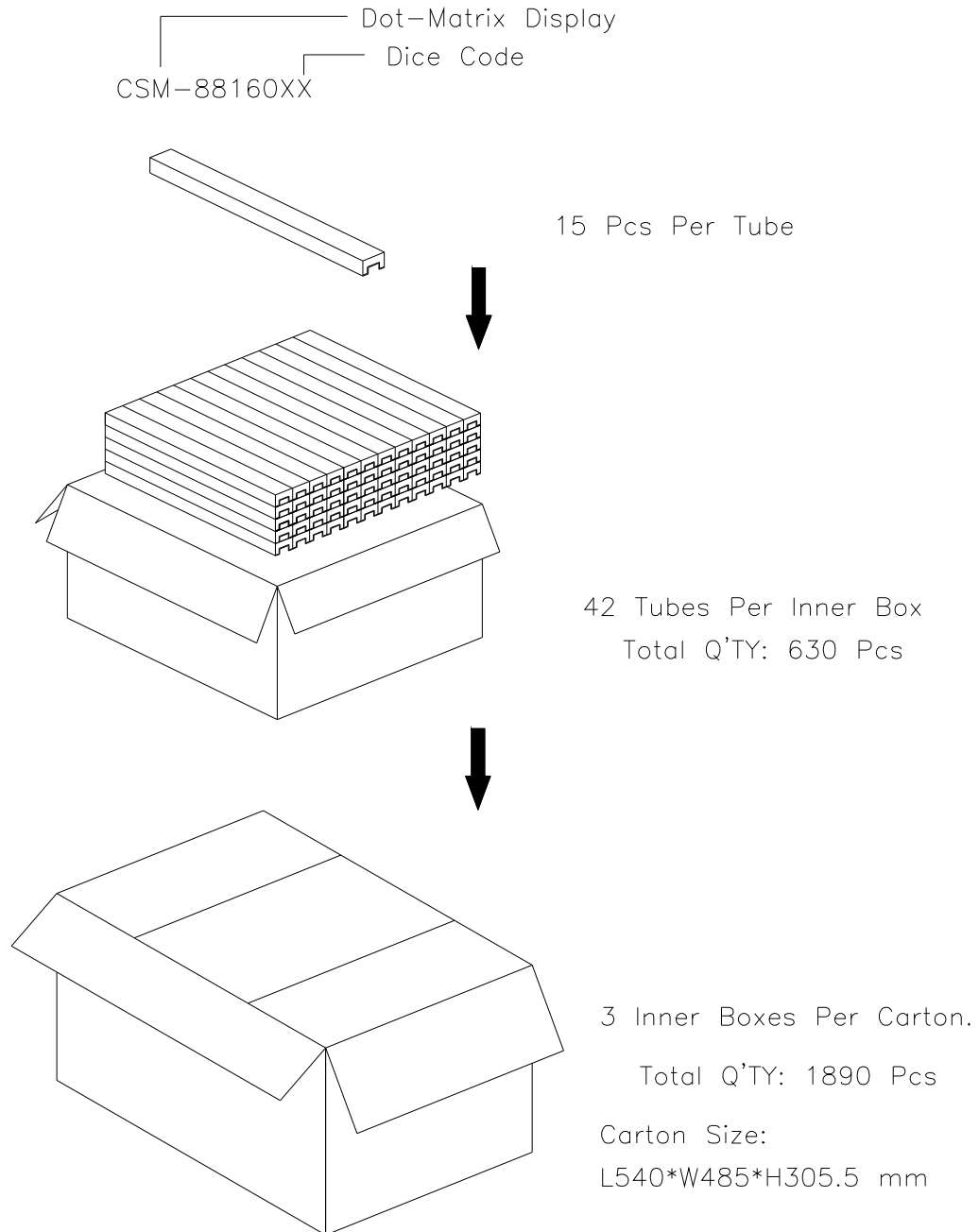

Note: The specifications are subject to change without notice. Please contact us for updated information.