

6 - 18 GHz Power Amplifier

TGA8014-SCC

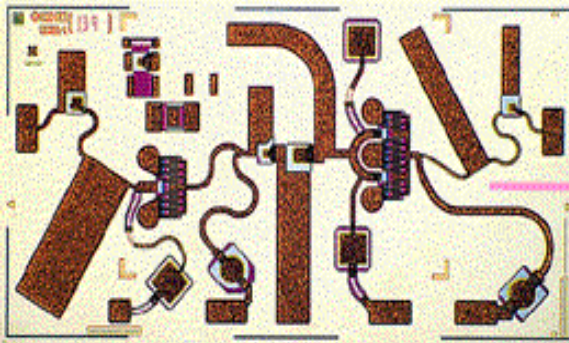

Key Features and Performance

- 6 to 18 GHz Frequency Range
- 11 dB Typical Gain
- Greater Than 0.5 Watt Output Power at 1 dB Gain Compression
- Designed for Balanced Configuration
- Unconditionally Stable
- 3.6068 x 1.9304 x 0.1016 mm (0.142 x 0.076 x 0.004 in.)

Description

The TriQuint TGA8014-SCC is a two-stage GaAs monolithic medium power amplifier. Reactively matched 914 μm and 1219 μm FETS provide 11 dB nominal gain with 16 percent typical power-added efficiency and output power at 1 dB gain compression of 0.5 watt. Ground is provided to the circuitry through vias to the backside metallization. The TGA8014-SCC provides 27 dBm typical output power at 1 dB gain compression.

The small size and inherent reliability advantages of a monolithic device over a hybrid design make this device attractive for use in a variety of military applications. Used in a balanced configuration, the TGA8014-SCC effectively addresses applications such as driver and power stages in EW amplifiers, local oscillator buffers, and TWT replacement amplifiers.

Bond pad and backside metallization is gold plated for compatibility with eutectic alloy attachment methods as well as the thermocompression and thermosonic wire-bonding processes. The TGA8014-SCC is supplied in chip form and is readily assembled using automated equipment.

**TYPICAL
OUTPUT POWER**
 P_{1dB}

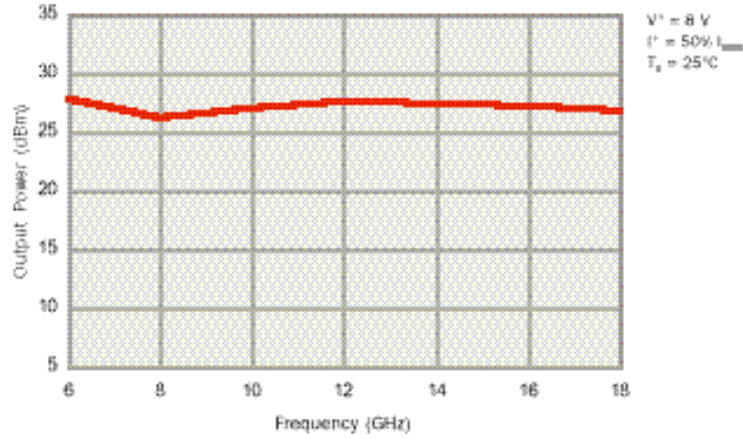

**TYPICAL
SMALL-SIGNAL
POWER GAIN**

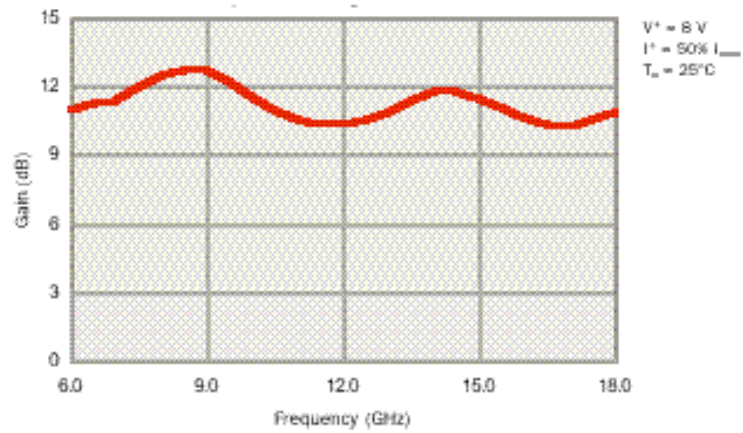

**TYPICAL
RETURN LOSS**

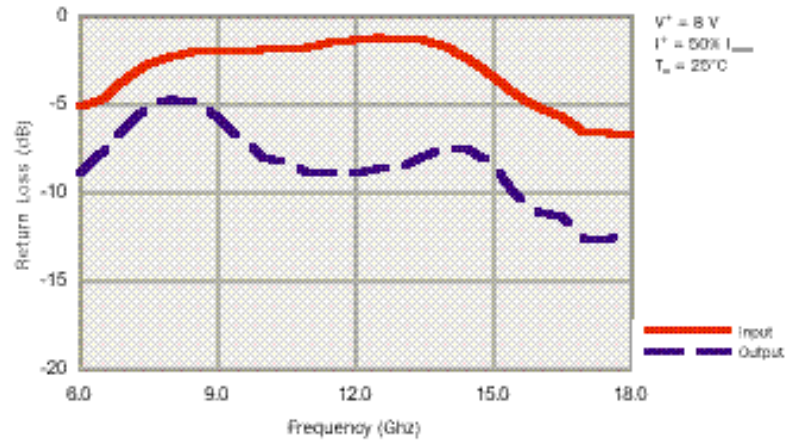

TABLE I
 MAXIMUM RATINGS

SYMBOL	PARAMETER	VALUE
V ⁺	POSITIVE SUPPLY VOLTAGE	8.5V
I ⁺	POSITIVE SUPPLY CURRENT (50% I _{DSS})	320mA to 462mA
I ⁻	NEGATIVE SUPPLY CURRENT	-9.7mA
V ⁻	NEGATIVE SUPPLY VOLTAGE RANGE	-5V to 0V
P _D	POWER DISSIPATION, AT (OR BELOW) 25°C BASE-PLATE TEMPERATURE *	5W
P _{IN}	INPUT CONTINUOUS WAVE POWER	28 dBm
T _{CH} **	OPERATING CHANNEL TEMPERATURE	150 °C
T _M	MOUNTING TEMPERATURE (30 SECONDS)	320 °C
T _{STG}	STORAGE TEMPERATURE	-65 to 150 °C

Ratings over channel temperature range, T_{CH} (unless otherwise noted)

Stresses beyond those listed under "Maximum Ratings" may cause permanent damage to the device.

These are stress ratings only, and functional operation of the device at these or any other conditions beyond those indicated under "RF Specifications" is not implied. Exposure to maximum rated conditions for extended periods may affect device reliability.

*For operation above 25°C base-plate temperature, derate linearly at the rate of 10.8mW/°C.

** Operating channel temperature, T_{CH}, directly affects the device MTTF. For maximum life, it is recommended that channel temperature be maintained at the lowest possible level.

TABLE II
DC PROBE TESTS (100%)
($T_A = 25\text{ }^\circ\text{C} \pm 5\text{ }^\circ\text{C}$)

NOTES	SYMBOL	TEST CONDITIONS <u>3/</u>	LIMITS		UNITS
			MIN	MAX	
<u>5/</u>	I_{DSS1}	STD	228	356	mA
<u>5/</u>	I_{DSS2}	STD	305	475	mA
<u>3/</u> , <u>5/</u>	G_{m1}	STD	119	182	mS
<u>3/</u> , <u>5/</u>	G_{m2}	STD	159	243	mS
<u>1/</u> , <u>3/</u> , <u>5/</u>	$ V_{P1} $	STD	2.2	3.8	V
<u>1/</u> , <u>3/</u> , <u>5/</u>	$ V_{P2} $	STD	2.2	3.8	V
<u>1/</u> , <u>5/</u>	$ V_{BVG D1} $	STD	8	30	V
<u>1/</u> , <u>5/</u>	$ V_{BVG D2} $	STD	8	30	V
<u>1/</u> , <u>5/</u>	$ V_{BVG S1} $	STD	8	30	V
<u>1/</u> , <u>5/</u>	$ V_{BVG S2} $	STD	8	30	V

- 1/ V_P , $V_{BVG D}$, and $V_{BVG S}$ are negative.
- 2/ Intermediate high current FET family is standard product since August 1, 1990.
- 3/ $V_{DSS} = V_{DS} @ I_{DSS}$.
- 4/ The measurement conditions are subject to change at the manufacture's discretion (with appropriate notification to the buyer).
- 5/ STD refers to Standard Test Conditions, see Table IV.

TABLE III
RF SPECIFICATIONS

($T_A = 25^\circ\text{C} \pm 5^\circ\text{C}$)
 $V^+ = 8\text{V}$, $I^+ = 341\text{mA}$

NOTE	TEST	MEASUREMENT CONDITIONS	VALUE			UNITS
			MIN	TYP	MAX	
	SMALL-SIGNAL GAIN MAGNITUDE	F = 6 – 18 GHz	8	11		dB
	POWER OUTPUT AT 1 dB GAIN COMPRESSION	F = 6 – 12 GHz	25.5	27		dBm
		F = 12 – 18 GHz	24	27		dBm
<u>2/</u>	INPUT STANDING WAVE RATIO	F = 6 – 18 GHz		4.5:1		
	OUTPUT STANDING WAVE RATIO	F = 6 – 18 GHz		2.2:1		
<u>1/</u>	GAIN DRIFT	F = 10 GHz			0.25	dB
	OUTPUT THIRD ORDER INTERCEPT POINT	F = 10 GHz		36.7		dBm
		F = 18 GHz		36.7		dBm

1/ Gain drift shall be defined as the change in small signal gain from the application of DC power to 30 minutes.

2/ The TGA8014-SCC is intended strictly for use in a balanced configuration.

TABLE IV
AUTOPROBE FET PARAMETER MEASUREMENT CONDITONS

FET Parameters	Test Conditions
I_{DSS} : Maximum drain current (I_{DS}) with gate voltage (V_{GS}) at zero volts.	$V_{GS} = 0.0$ V, drain voltage (V_{DS}) is swept from 0.5 V up to a maximum of 3.5 V in search of the maximum value of I_{DS} ; voltage for I_{DSS} is recorded as VDSP.
G_m : Transconductance; $\frac{(I_{DSS} - IDS1)}{VG1}$	For all material types, V_{DS} is swept between 0.5 V and VDSP in search of the maximum value of I_{ds} . This maximum I_{DS} is recorded as IDS1. For Intermediate and Power material, IDS1 is measured at $V_{GS} = VG1 = -0.5$ V. For Low Noise, HFET and pHEMT material, $V_{GS} = VG1 = -0.25$ V. For LNBECOLC, use $V_{GS} = VG1 = -0.10$ V.
V_P : Pinch-Off Voltage; V_{GS} for $I_{DS} = 0.5$ mA/mm of gate width.	V_{DS} fixed at 2.0 V, V_{GS} is swept to bring I_{DS} to 0.5 mA/mm.
V_{BVGD} : Breakdown Voltage, Gate-to-Drain; gate-to-drain breakdown current (I_{BD}) = 1.0 mA/mm of gate width.	Drain fixed at ground, source not connected (floating), 1.0 mA/mm forced into gate, gate-to-drain voltage (V_{GD}) measured is V_{BVGD} and recorded as BVGD; this cannot be measured if there are other DC connections between gate-drain, gate-source or drain-source.
V_{BVGS} : Breakdown Voltage, Gate-to-Source; gate-to-source breakdown current (I_{BS}) = 1.0 mA/mm of gate width.	Source fixed at ground, drain not connected (floating), 1.0 mA/mm forced into gate, gate-to-source voltage (V_{GS}) measured is V_{BVGS} and recorded as BVGS; this cannot be measured if there are other DC connections between gate-drain, gate-source or drain-source.

TYPICAL S-PARAMETERS

FREQUENCY (GHz)	S ₁₁		S ₂₁		S ₁₂		S ₂₂		GAIN (dB)
	MAG	ANG	MAG	ANG	MAG	ANG	MAG	ANG	
6.0	0.55	176	3.55	29	0.002	167	0.36	4	11.0
6.5	0.58	173	3.69	-34	0.005	150	0.41	-35	11.3
7.0	0.66	168	3.73	-80	0.006	135	0.48	-73	11.4
7.5	0.73	160	3.98	-120	0.008	119	0.55	-105	12.0
8.0	0.77	150	4.25	-159	0.010	96	0.58	-135	12.6
8.5	0.79	142	4.36	163	0.010	77	0.57	-160	12.8
9.0	0.79	134	4.31	127	0.009	54	0.52	179	12.7
9.5	0.79	127	4.09	93	0.008	33	0.45	164	12.2
10.0	0.80	120	3.81	62	0.006	10	0.40	153	11.6
10.5	0.81	113	3.55	33	0.005	-10	0.38	143	11.0
11.0	0.82	105	3.39	8	0.004	-42	0.36	131	10.6
11.5	0.84	97	3.32	-18	0.004	-82	0.36	119	10.4
12.0	0.85	87	3.32	-42	0.004	-122	0.36	105	10.4
12.5	0.87	77	3.40	-68	0.005	-133	0.37	87	10.6
13.0	0.86	66	3.49	-94	0.006	-152	0.37	70	10.8
13.5	0.85	54	3.70	-121	0.010	180	0.40	52	11.4
14.0	0.82	40	3.89	-151	0.011	155	0.42	30	11.8
14.5	0.76	27	3.92	178	0.012	136	0.42	8	11.9
15.0	0.68	14	3.78	146	0.014	111	0.38	-13	11.6
15.5	0.60	6	3.59	118	0.014	78	0.31	-27	11.1
16.0	0.55	-4	3.43	89	0.015	39	0.28	-37	10.7
16.5	0.52	-16	3.32	59	0.010	-8	0.27	-51	10.4
17.0	0.47	-26	3.28	32	0.009	-4	0.23	-68	10.3
17.5	0.47	-43	3.39	1	0.017	-40	0.23	-88	10.6
18.0	0.46	-69	3.50	-34	0.017	-82	0.25	-119	10.9

T_A = 25°C, V₊ = 8 V, I₊ = 50% I_{DSS}

Reference planes for S-parameter data include bond wires as specified in the "Recommended Assembly Diagram." The S-parameters are also available on floppy disk and the world wide web.

THERMAL INFORMATION

PARAMETER	TEST CONDITION	NOM	UNIT
$R_{\theta JC}$ Thermal resistance (channel to backside)	$V^+ = 8\text{ V}$, $I^+ = 50\% I_{DSS}$	30	°C/W

EQUIVALENT SCHEMATIC

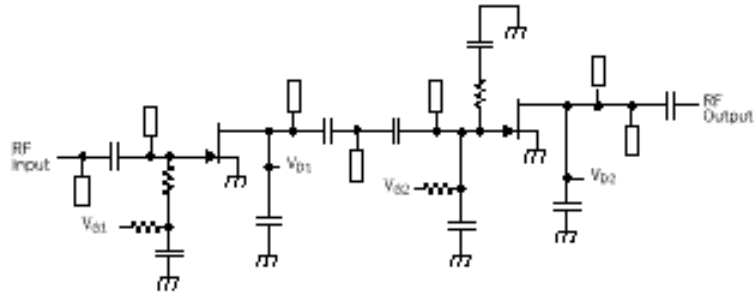

RECOMMENDED ASSEMBLY DIAGRAM

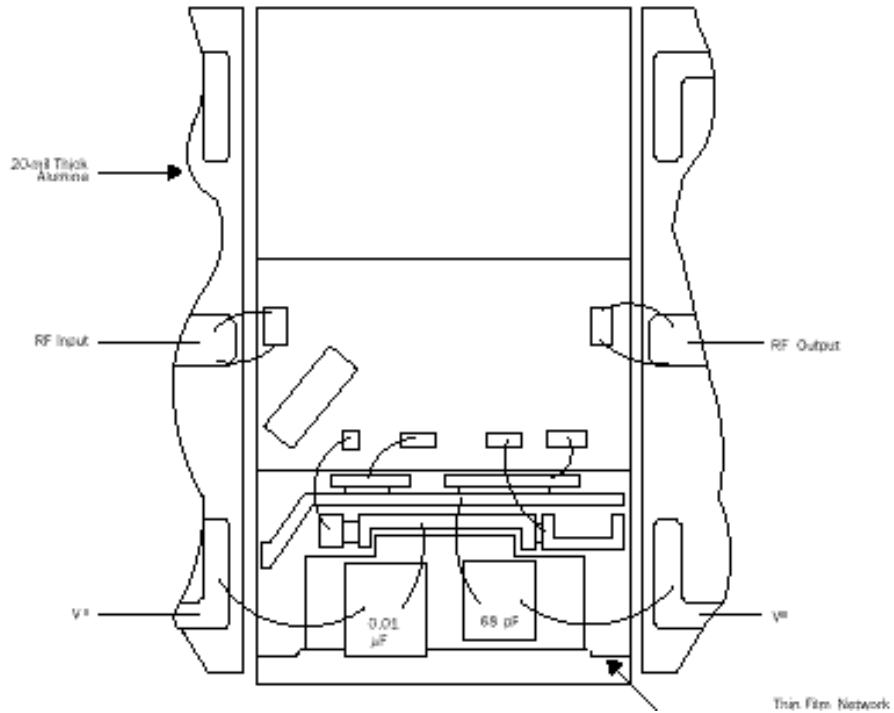

RF connections: Bond two 1-mil diameter, 25-mil-length gold bond wires at both RF Input and RF Output for optimum RF performance.

Close placement of external components is essential to stability.

Refer to TriQuint's Recommended Assembly Instructions for GaAs Products.

GaAs MMIC devices are susceptible to damage from Electrostatic Discharge. Proper precautions should be observed during handling, assembly and test.

MECHANICAL DRAWING

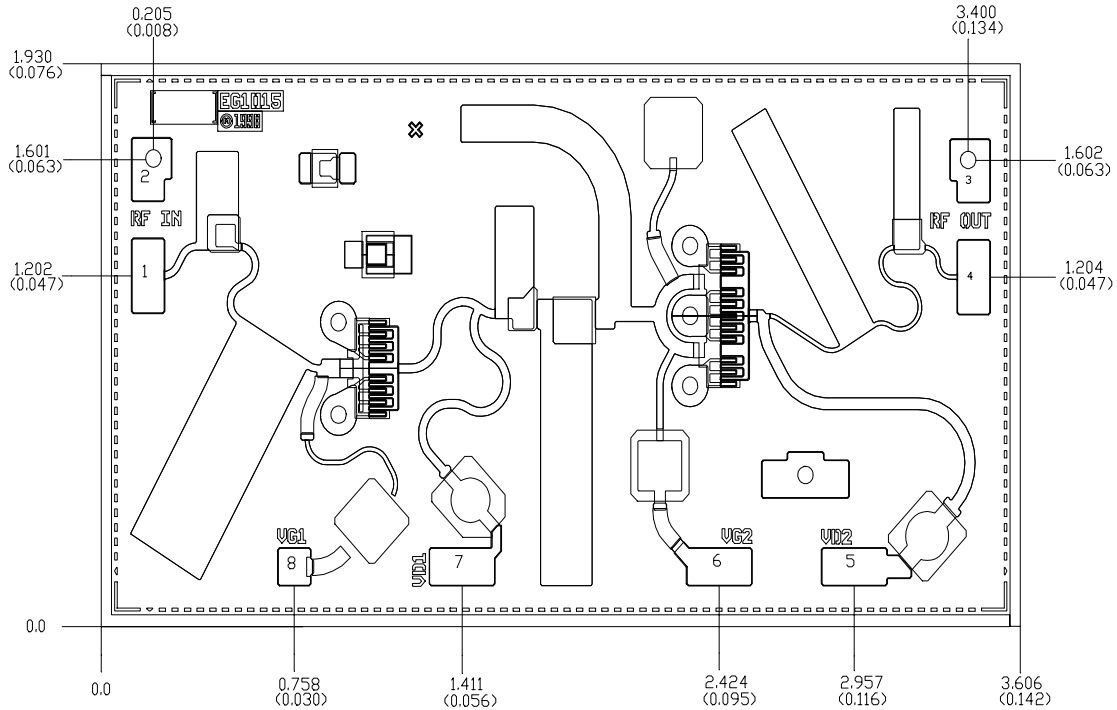

Units: millimeters (inches)

Thickness: 0.1016 (0.004)

Chip edge to bond pad dimensions are shown to center of bond pad

Chip size tolerance: +/- 0.051 (0.002)

Bond Pad #1 (RF Input)	0.132 x 0.259 (0.005 x 0.010)
Bond Pad #2 (GND)	0.132 x 0.220 (0.005 x 0.009)
Bond Pad #3 (GND)	0.132 x 0.220 (0.005 x 0.009)
Bond Pad #4 (RF Output)	0.132 x 0.259 (0.005 x 0.010)
Bond Pad #5 (VD2)	0.132 x 0.265 (0.005 x 0.010)
Bond Pad #6 (VG2)	0.132 x 0.259 (0.005 x 0.010)
Bond Pad #7 (VD1)	0.132 x 0.259 (0.005 x 0.010)
Bond Pad #8 (VG1)	0.132 x 0.133 (0.005 x 0.005)

GaAs MMIC devices are susceptible to damage from Electrostatic Discharge. Proper precautions should be observed during handling, assembly and test.

Assembly Process Notes

Reflow process assembly notes:

- Use AuSn (80/20) solder with limited exposure to temperatures at or above 300°C.
- An alloy station or conveyor furnace with reducing atmosphere should be used.
- No fluxes should be utilized.
- Coefficient of thermal expansion matching is critical for long-term reliability.
- Devices must be stored in a dry nitrogen atmosphere.

Component placement and adhesive attachment assembly notes:

- Vacuum pencils and/or vacuum collets are the preferred method of pick up.
- Air bridges must be avoided during placement.
- The force impact is critical during auto placement.
- Organic attachment can be used in low-power applications.
- Curing should be done in a convection oven; proper exhaust is a safety concern.
- Microwave or radiant curing should not be used because of differential heating.
- Coefficient of thermal expansion matching is critical.

Interconnect process assembly notes:

- Thermosonic ball bonding is the preferred interconnect technique.
- Force, time, and ultrasonics are critical parameters.
- Aluminum wire should not be used.
- Discrete FET devices with small pad sizes should be bonded with 0.0007-inch wire.
- Maximum stage temperature is 200°C.

GaAs MMIC devices are susceptible to damage from Electrostatic Discharge. Proper precautions should be observed during handling, assembly and test.