

**I/Q Modulator/Demodulator  
850-960 MHz**

**MAMO-000900-1291LT**

**V2**

**Features**

- Excellent Carrier Suppression ~40 dBc
- 6.0 dB Typical Modulator Conversion Loss
- +9 to +13 dBm LO Drive
- High 3x1 and 5x1 Harmonic Suppression
- No External Matching Required
- Low Cost Miniature Plastic MLP Package
- Lead Free and RoHS Compliant

**Description and Application**

M/A-COM's MAMO-000900-1291LT is a silicon monolithic 850-960 MHz, medium barrier, I/Q Modulator/Demodulator. Encapsulated in a low cost, miniature surface mount PQFN 6mm square, 28-lead plastic package the die utilizes M/A-COM's unique HMIC silicon/glass process. This process enables the realization of low loss passive elements and efficient diode technology which in turn provides excellent harmonic suppression. In addition, the incorporated monolithic design techniques provide unparalleled amplitude and phase imbalance performance during demodulation thus adding to the unit's overall versatility.

These modulators/demodulators are well suited for GSM and CDMA Cellular basestation applications, as well as most RFID systems, particularly where small size and high performance are required. Typical applications include quadrature modulation requirements in wireless receivers and transmitters.

**Absolute Maximum Ratings<sup>1,2</sup>**

Parameter	Maximum Ratings
Operating Temperature	-40 °C to +85 °C
Storage Temperature	-65 °C to +150 °C
Incident LO Power	+20 dBm C.W.
Incident RF Power	+20 dBm C.W.

1. Exceeding these limits may cause permanent damage.
2. M/A-COM does not recommend sustained operation near these survivability limits.

**MLP 6mm Package  
Circuit Side View**

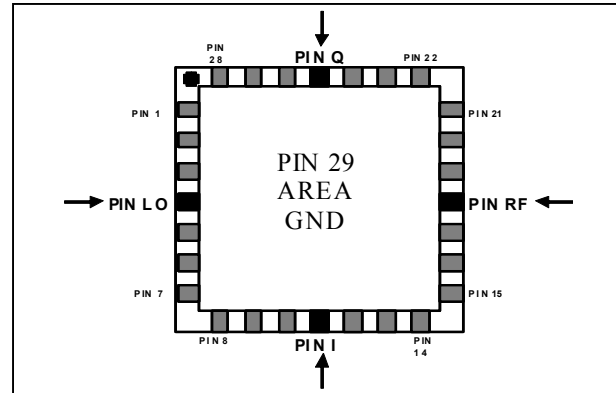

**PIN Configuration<sup>3</sup>**

PIN	Function	PIN	Function
1	GND	15	GND
2	GND	16	GND
3	GND	17	GND
4	LO	18	RF
5	GND	19	GND
6	GND	20	GND
7	GND	21	GND
8	GND	22	GND
9	GND	23	GND
10	GND	24	GND
11	I	25	Q
12	GND	26	GND
13	GND	27	GND
14	GND	28	GND

3. The exposed pad centered on the package bottom must be connected to RF and DC ground. (For PQFN Packages)

**Ordering Information**

Part Number	Package
MAMO-000900-1291LT	Tape and Reel
MAMO-000900-1291LB	Sample Test Board

- **North America** Tel: 800.366.2266 / Fax: 978.366.2266
- **Europe** Tel: 44.1908.574.200 / Fax: 44.1908.574.300
- **Asia/Pacific** Tel: 81.44.844.8296 / Fax: 81.44.844.8298

Visit [www.macom.com](http://www.macom.com) for additional data sheets and product information.

**Electrical Specifications (Modulator):  $T_A = 25^\circ\text{C}$ ,  $Z_0 = 50\Omega$**

Parameter	Frequency Range	Test Conditions	Units	Min	Typ	Max
Output Power	900 MHz 850-960 MHz	LO Drive = +11 dBm I/Q = -7 dBm, I/Q = 400 kHz $F_{RF} = F_{LO} - 0.4 \text{ MHz}$	dBm	-14.5 -15	-13.5 -14	- -
LO Carrier Suppression	850-960 MHz	LO Drive = +11 dBm I/Q = -7 dBm, I/Q = 400 kHz $F_{RF} = F_{LO} - 0.4 \text{ MHz}$	dBc	36	42	-
SSB Rejection <sup>4</sup>	850-960 MHz	LO Drive = +11 dBm I/Q = -7 dBm, I/Q = 400 kHz $F_{RF} = F_{LO} + 0.4 \text{ MHz}$	dBc	28	38	-
3 x 1 Harmonic Suppression	850-960 MHz	LO Drive = +11 dBm I/Q = -7 dBm, I/Q = 400 kHz $F_{RF} = F_{LO} + 1.2 \text{ MHz}$	dBc	50	58	-
5 x 1 Harmonic Suppression	850-960 MHz	LO Drive = +11 dBm I/Q = -7 dBm, I/Q = 400 kHz $F_{RF} = F_{LO} + 2.0 \text{ MHz}$	dBc	78	85	-
ACPR CDMA 2000 <sup>5</sup>	900 MHz Carrier Freq	LO Drive = +11 dBm BB AC Voltage = 275mVp-p	dBc	67	74	-
Output Noise Floor	850-960 MHz	LO Drive = +11 dBm I/Q Power level = -7 dBm	dBm/Hz	-	-161	-
LO Port Return Loss	850-960 MHz	LO Drive = +11 dBm I/Q Power level = -7 dBm $F_{RF} = F_{LO} + 0.4 \text{ MHz}$	dB	20	29	-
RF Port Return Loss	850-960 MHz	LO Drive = +11 dBm I/Q Power level = -7 dBm $F_{RF} = F_{LO} + 0.4 \text{ MHz}$	dB	6	9	-
IF Bandwidth	$850 \leq LO \leq 970 \text{ MHz}$	LO Drive = +11 dBm I/Q Power level = -7 dBm	MHz	65	-	-

4. When the LO frequency is greater than the RF frequency, the upper sideband is suppressed.

5. The Baseband I and Q input signals were generated using the following settings in the Agilent E3844C Vector Signal Generator:

FWD CDMA2000 SR1 Pilot  
Filter: IS-95 Mod w/EQ  
Link: Forward  
IQ Mod Filter: Through  
PRE Clip: 100.0 %

**Modulator Band Performance 850-960 MHz**

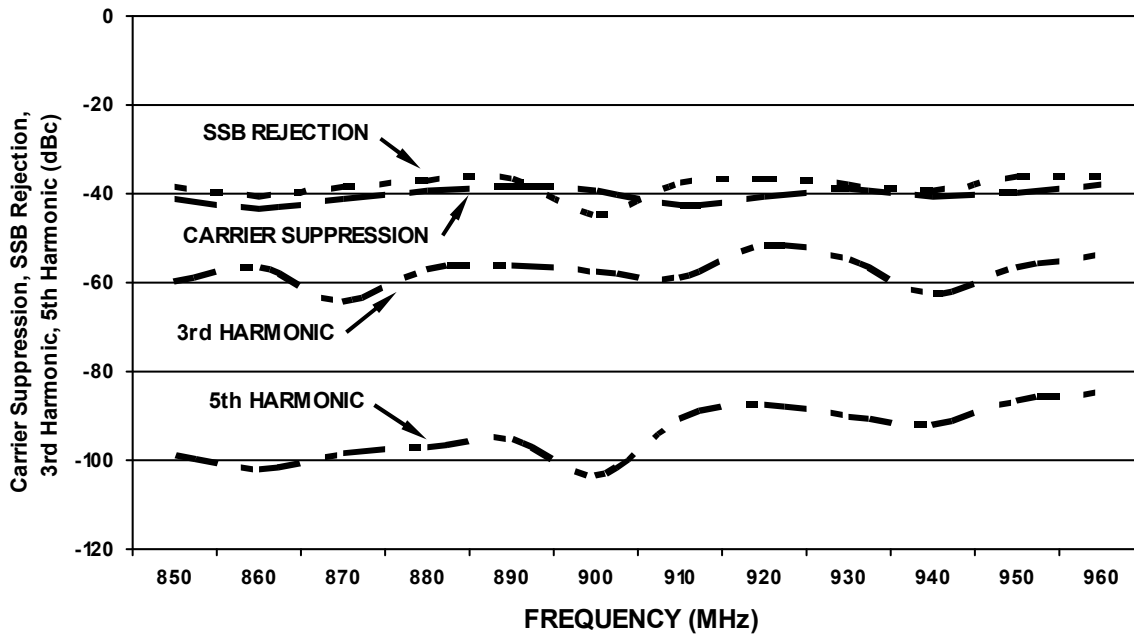

**Modulator/Demodulator Return Loss 850-960 MHz**

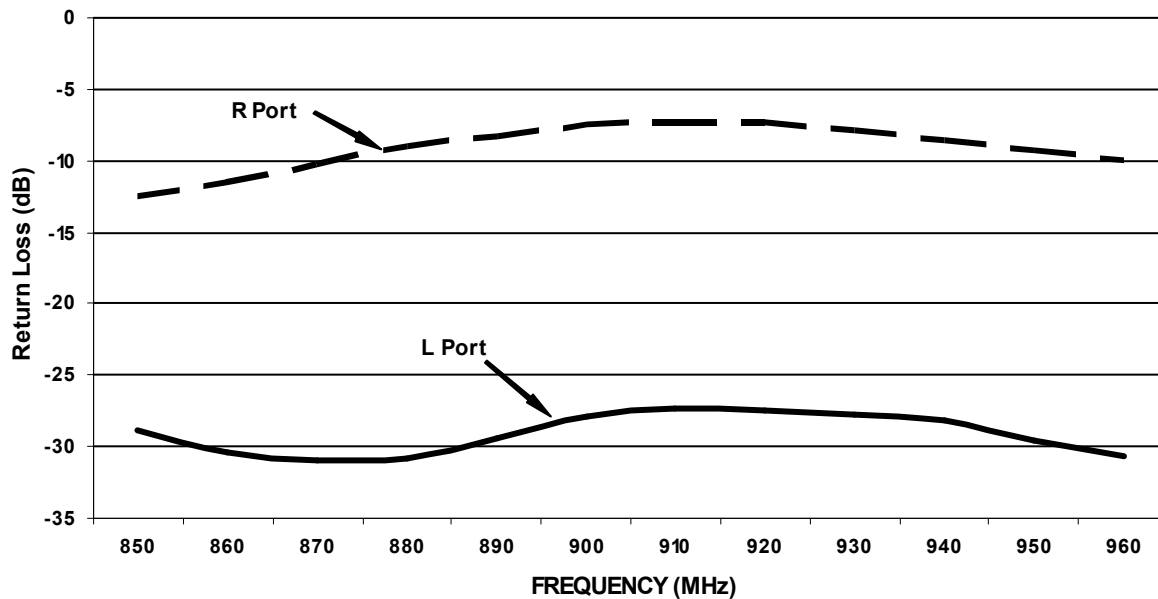

**Output Power 850-960 MHz**

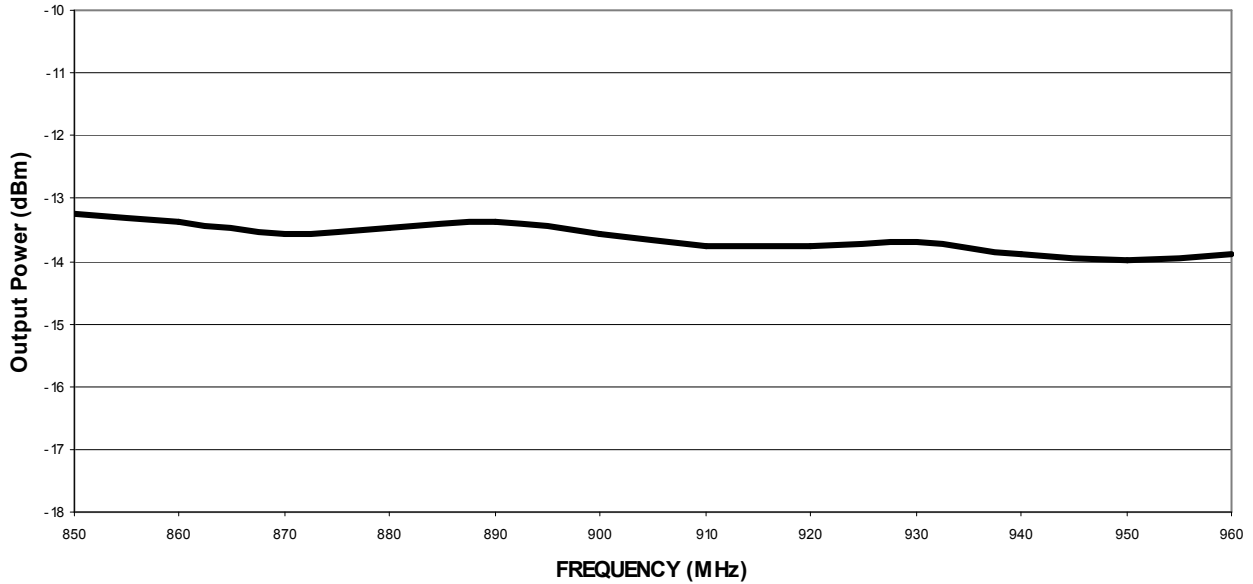

**Output Noise Floor**

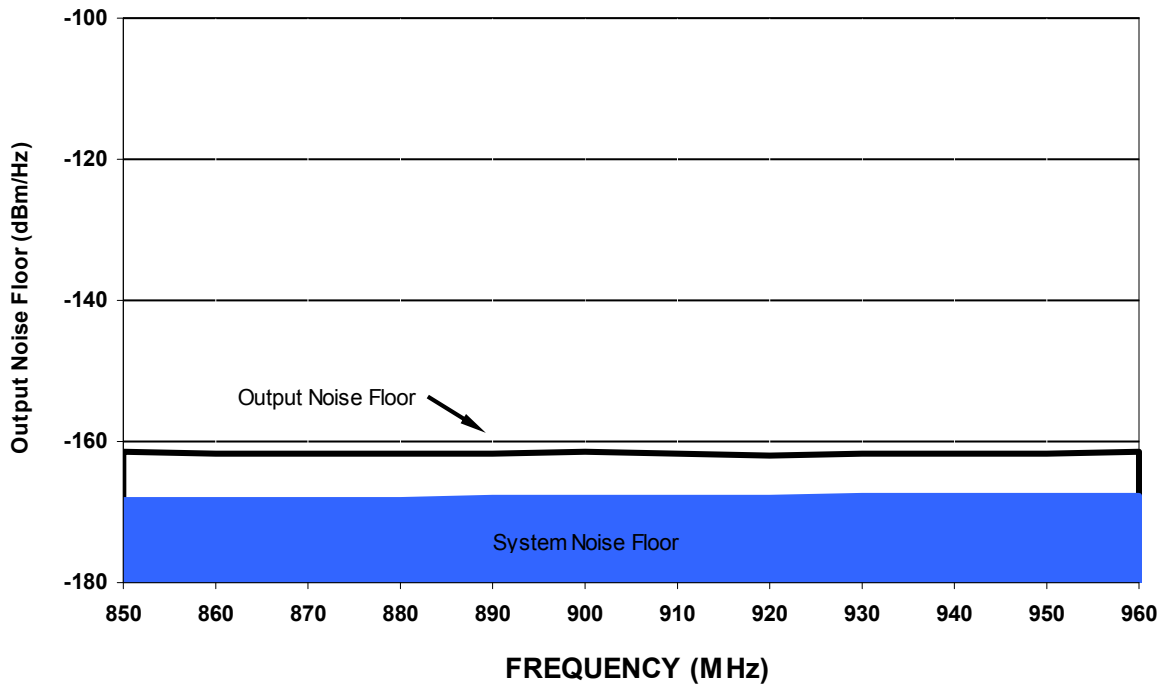

**Electrical Specifications (Demodulator) @ +25 °C, Z<sub>0</sub> = 50Ω**

Parameter	Frequency Range	Test Conditions	Units	Min	Typ	Max
Conversion Loss	900 MHz 850-960 MHz	LO Drive = +11 dBm RF Input = -7 dBm F <sub>RF</sub> = F <sub>LO</sub> + 0.4 MHz	dB	- -	12.2 12.6	13 14
Amplitude Imbalance	850-960 MHz	LO Drive = +11 dBm RF Input = -7 dBm F <sub>RF</sub> = F <sub>LO</sub> + 0.4 MHz	dB	-	0.06	0.3
Phase Imbalance <sup>6</sup>	850-960 MHz	LO Drive = +11 dBm RF Input = -7 dBm F <sub>RF</sub> = F <sub>LO</sub> + 0.4 MHz	deg	-	1.0	3.0
Input IP3	850-960 MHz	LO Drive = +11 dBm RF Input = -7 dBm (each tone) Tone 1 is 10 MHz above LO Freq Tone 2 is 11 MHz above LO Freq	dBm	21.5	23.5	-
Input 1dB Compression	900 MHz 850-960 MHz	LO Drive = +11 dBm F <sub>RF</sub> = F <sub>LO</sub> + 0.4 MHz	dBm	7	8.6	-
IF Bandwidth	-	850 MHz ≤ LO ≤ 970 MHz F <sub>RF</sub> = F <sub>LO</sub> + F <sub>IF</sub> ; 0 ≤ F <sub>IF</sub> ≤ 65 MHz	MHz	65	-	-
LO Return Loss	850-960 MHz	LO Drive = +11 dBm RF Input = -7 dBm F <sub>RF</sub> = F <sub>LO</sub> + 0.4 MHz	dB	20	26	-
RF Return Loss	850-960 MHz	LO Drive = +11 dBm RF Power Level = -10 dBm RF Input = -7 dBm F <sub>RF</sub> = F <sub>LO</sub> + 0.4 MHz	dB	6	9	-

6. When the LO frequency is greater than the RF frequency, the “Q” output leads the “I” output by 90 degrees nominal.

**Demodulator Conversion Loss 850-960 MHz**

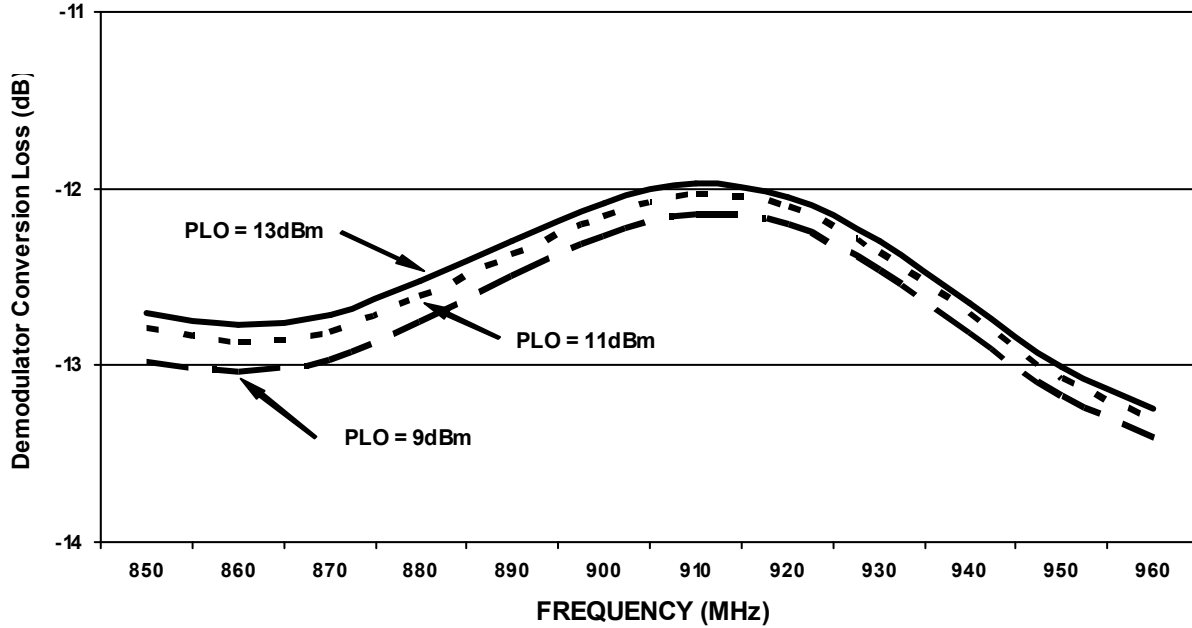

**Demodulator Input IP3 and Input 1dB Compression 850-960 MHz**

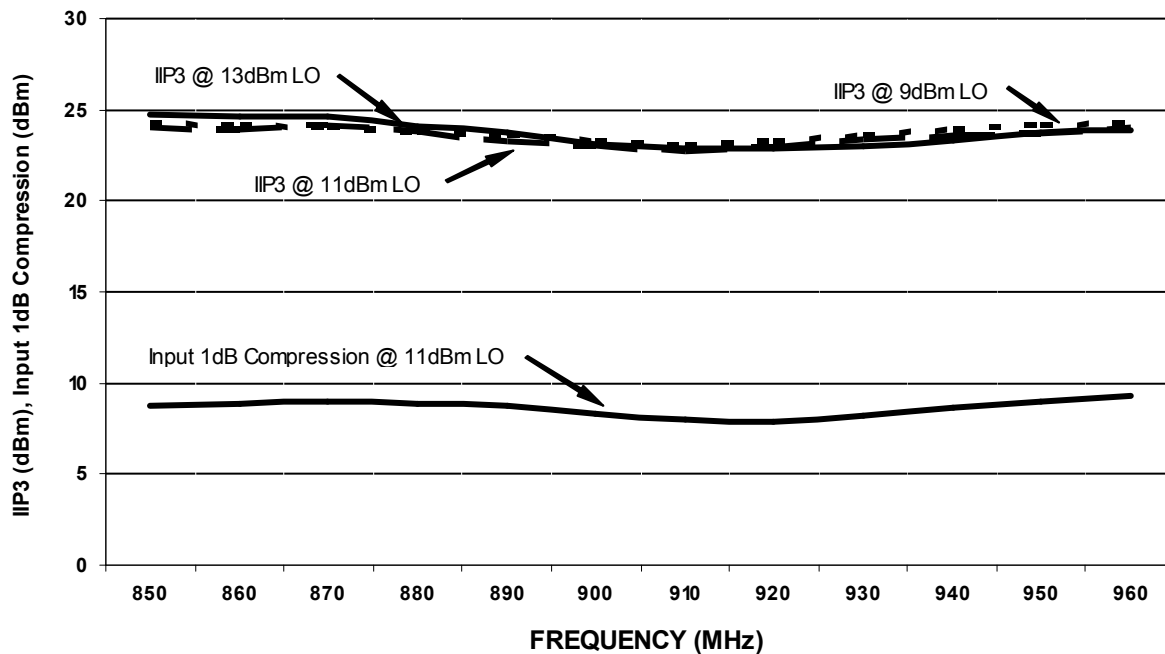

**Demodulator Phase and Amplitude Imbalance 850-960 MHz**

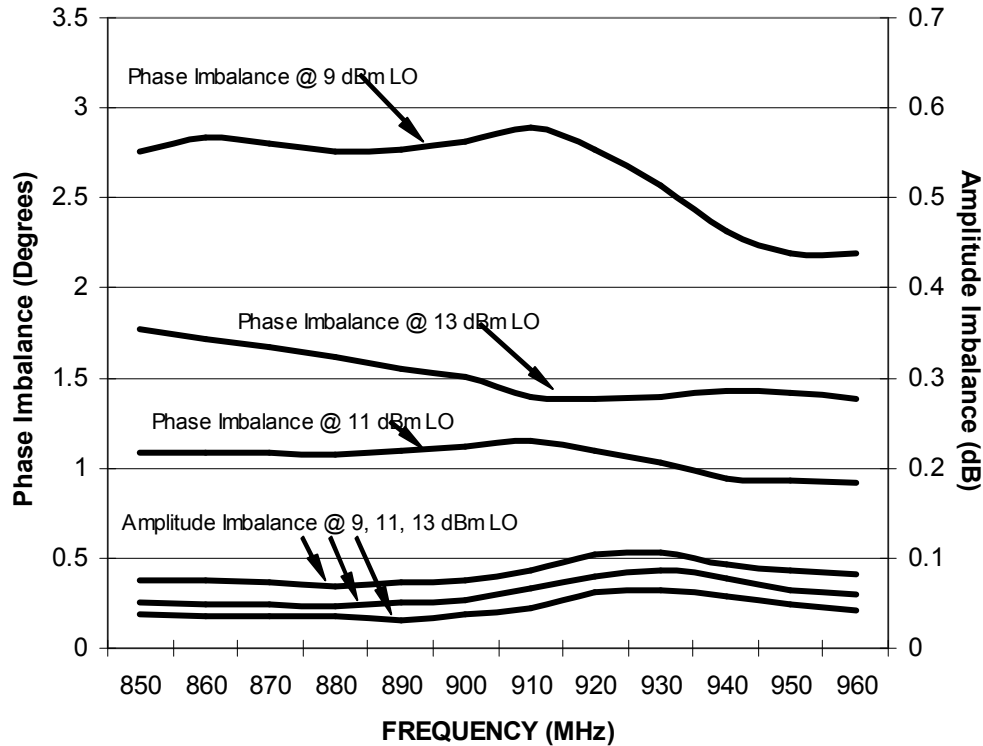

**MAMO-000900-1291MT Outline – 6mm PQFN, 28-Lead**

