

### Product Dimensions

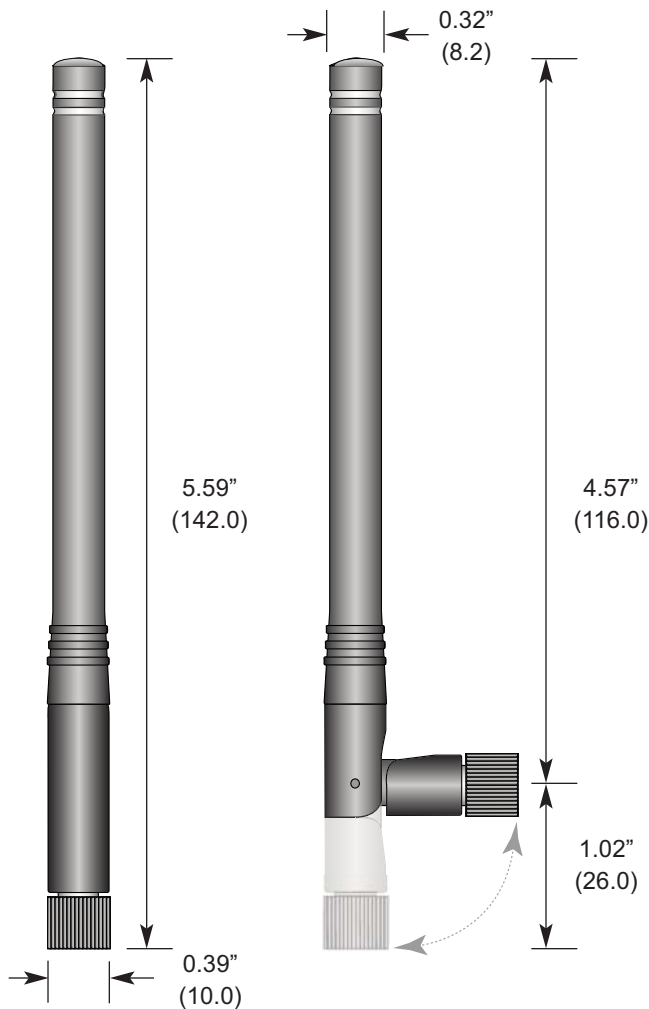

### Description



HWR Series antennas deliver outstanding performance in a rugged and cosmetically attractive package. The articulating base allows the antenna to tilt 90 degrees and rotate 360 degrees. The antennas attach via a standard SMA or Part 15 compliant RP-SMA connector. Custom colors and connectors are available for volume OEM customers.

### Features

- Low cost
- Tilts and rotates
- Omni-directional pattern
- Outstanding VSWR
- Rugged & damage-resistant
- Standard SMA or Part 15 compliant RP-SMA connector
- Custom colors and terminations for volume OEMs
- Use with plastic\* or metal enclosures
- Internal O-ring seal on connector

\* Requires proximity ground plane

### Electrical Specifications

- Center Freq. 315MHz
- Recmd. Freq. Range 305-325MHz
- Wavelength 1/4-wave
- VSWR <2.0 typ. at center
- Impedance 50 ohms
- Connector RP-SMA or SMA

Electrical specifications and plots measured on 4.00" x 4.00" reference ground plane

### Ordering Information

- ANT-315-CW-HWR-RPS (with RP-SMA connector)
- ANT-315-CW-HWR-SMA (with SMA connector)

### Polar Plot & Gain Information

