

**PLEASE CHECK WWW.MOLEX.COM FOR LATEST PART INFORMATION**

**Part Number:** [0877592875](#)  
**Status:** **Active**  
**Overview:** milligrid  
**Description:** 2.00mm (.079") Pitch Milli-Grid™ Header, Surface Mount, Vertical, 28 Circuits, 0.76µm (30µ") Gold (Au) Selective Plating, with Pick-and-Place Cap, Tape and Reel Packaging, without Press-fit Plastic Pegs, Lead-free

**Documents:**

[3D Model](#) [Product Specification PS-87761-100 \(PDF\)](#)  
[Drawing \(PDF\)](#) [RoHS Certificate of Compliance \(PDF\)](#)

**Agency Certification**

UL E29179

**General**

Product Family PCB Headers  
 Series [87759](#)  
 Application Board-to-Board  
 Overview [milligrid](#)  
 Product Name Milli-Grid™

**Physical**

Breakaway Yes  
 Circuits (Loaded) 28  
 Circuits (maximum) 28  
 Color - Resin Black  
 Durability (mating cycles max) 100  
 First Mate / Last Break No  
 Flammability 94V-0  
 Glow-Wire Compliant No  
 Guide to Mating Part No  
 Keying to Mating Part None  
 Lock to Mating Part None  
 Mated Height (in) 0.150 In  
 Mated Height (mm) 3.80 mm  
 Material - Metal Phosphor Bronze  
 Material - Plating Mating Gold  
 Material - Plating Termination Tin  
 Material - Resin High Temperature Thermoplastic  
 Number of Rows 2  
 Orientation Vertical  
 PCB Locator No  
 PCB Retention None  
 Packaging Type Embossed Tape on Reel  
 Pitch - Mating Interface (in) 0.079 In  
 Pitch - Mating Interface (mm) 2.00 mm  
 Pitch - Term. Interface (in) 0.079 In  
 Pitch - Term. Interface (mm) 2.00 mm  
 Plating min: Mating (µin) 30  
 Plating min: Mating (µm) 0.76  
 Polarized to Mating Part No  
 Polarized to PCB No  
 Robotic Placement Pick and Place Cap  
 Shrouded No  
 Stackable Yes  
 Temperature Range - Operating -55°C to +105°C

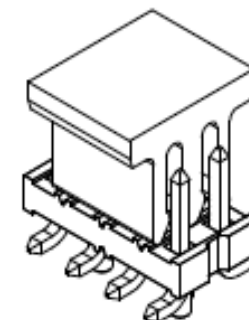

image - Reference only

Series

**EU RoHS**

**ELV and RoHS Compliant**  
**REACH SVHC Contains SVHC: No**  
**Halogen-Free Status**  
**Not Reviewed**

**China RoHS**



**Need more information on product environmental compliance?**

Email [productcompliance@molex.com](mailto:productcompliance@molex.com)  
 For a multiple part number RoHS Certificate of Compliance, [click here](#)

Please visit the [Contact Us](#) section for any non-product compliance questions.

**Search Parts in this Series**

[87759Series](#)

**Mates With**

[79107](#) Milli-Grid™ Receptacle, Vertical, Through Hole. [79108](#) Milli-Grid™ Flex-to-Board, Vertical Receptacle. Milli-Grid™ Receptacle, Surface Mount. [79109](#). [87381](#)

Termination Interface: Style Surface Mount

**Electrical**

Current - Maximum per Contact 2A  
Voltage - Maximum 125V

**Material Info**

**Reference - Drawing Numbers**

Packaging Specification PK-89990-485  
Product Specification PS-87761-100  
Sales Drawing SD-87759-118

This document was generated on 05/25/2010

**PLEASE CHECK [WWW.MOLEX.COM](http://WWW.MOLEX.COM) FOR LATEST PART INFORMATION**

10 9 8 7 6 5 4 3 2 1

F

E

D

C

B

A

F

E

D

C

B

A

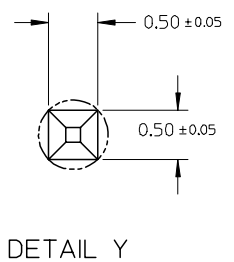
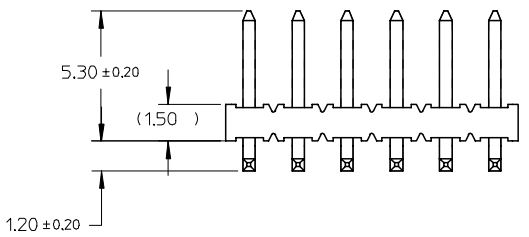
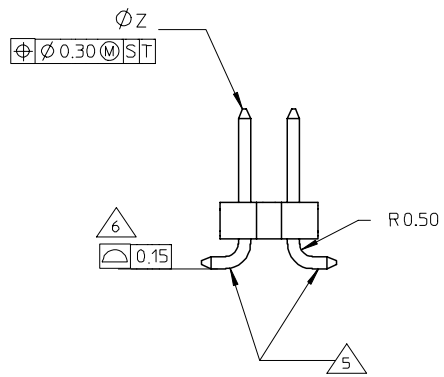
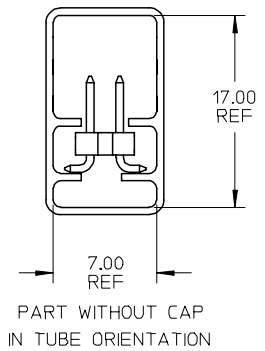
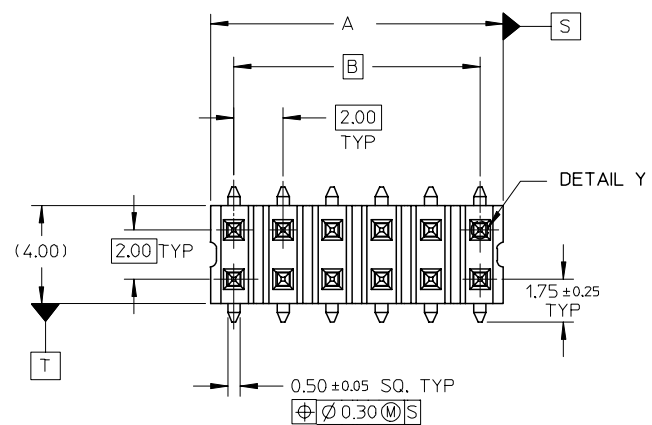

NOTE:

1. MATERIAL:  
HSG & CAP - LCP,  
UL 94V-0, COLOUR BLACK
- PIN - 0.50 SQ PHOSPHOR BRONZE
2. PLATING:  
0.76um MIN GOLD PLATE AT CONTACT AREA,  
TIN PLATE AT SOLDER AREA,  
BOTH OVER NICKEL UNDERPLATE
3. PIN PUSHOUT FORCE: 1KG MIN IN EITHER DIRECTION
4. PRODUCT SPEC PS-87761-100 APPLIES.
5. BEND DEPRESSION IS ACCEPTABLE SO LONG AS IT DOES NOT AFFECT THE OVERALL COPLANARITY OF TAIL.
6. COPLANARITY IS TO BE MEASURED BY RESTING THE SOLDER TAIL ON A FLAT SURFACE.
7. CAP TO BE LOCATED AS CENTRAL OF PART AS POSSIBLE  
TOP SURFACE OF CAP TO BE FLAT FOR THE PURPOSE OF PICK & PLACE BY VACUUM SUCTION NOZZLE.
8. FOR ILLUSTRATION PURPOSES, 12CKT IS SHOWN.
9. CKT 4 & 6 IS CUT FROM CKT 8 & 12 RESPECTIVELY  
ROUGH EDGES ARE EXPECTED ALONG THE CUTTING EDGES.
10. PART TO BE PACKED IN TRAY 10 ONLY.
11. TUBE LENGTH IS 560MM REF STANDARD.

REVISED TUBE SPEC EC NO: S2007-0829 DRWNS:SKLIM01 CHKD:CLAM APPR:KWLEE	DESCRIPTION 2007/04/10 2007/04/12 2007/04/17	QUALITY SYMBOLS	GENERAL TOLERANCES (UNLESS SPECIFIED)		DIMENSION STYLE MM ONLY		SCALE NTS	DESIGN UNITS METRIC	THIRD ANGLE PROJECTION		
		▽=0 ∇=0	mm	INCH	DRAWN BY KSEE	DATE 2003/12/17	TITLE MGRID, 2MM DUAL ROW HEADER, SMT				
			4 PLACES ± ---	± ---	CHECKED BY KCLING	DATE 2004/01/12					
			3 PLACES ± ---	± ---	APPROVED BY SKTOH	DATE 2004/01/12					
	2 PLACES ± 0.2	± ---	ANGULAR ± 3 °		MATERIAL NO.		DOCUMENT NO.	SHEET NO.			
	1 PLACE ± ---	± ---	DRAFT WHERE APPLICABLE MUST REMAIN WITHIN DIMENSIONS		SEE TABLE		SD-87759-118		1 OF 4		
					SIZE A3		THIS DRAWING CONTAINS INFORMATION THAT IS PROPRIETARY TO MOLEX INCORPORATED AND SHOULD NOT BE USED WITHOUT WRITTEN PERMISSION				

9 8 7 6 5 4 3 2 1

10 9 8 7 6 5 4 3 2 1

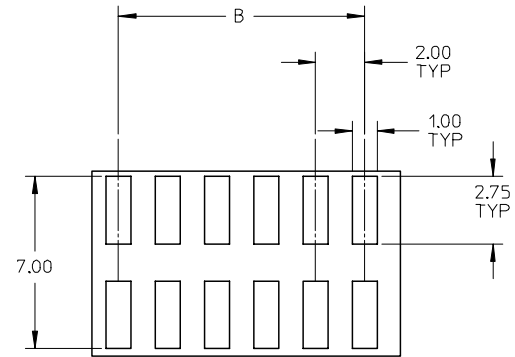
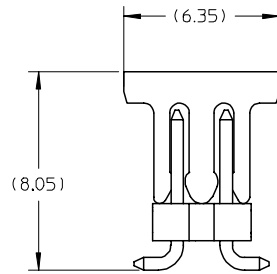
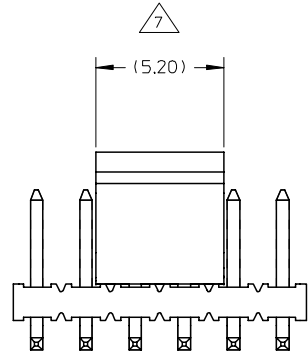

RECOMMENDED SOLDER PAD LAYOUT

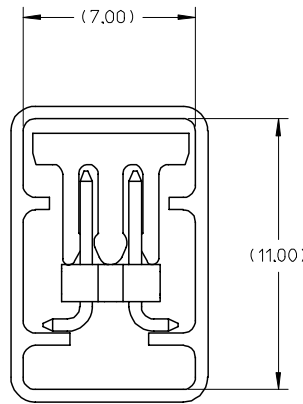
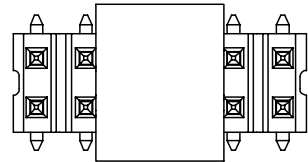

PART WITH CAP IN TUBE ORIENTATION

REVISED TUBE SPEC	DESCRIPTION
EC NO: S2007-0829	2007/04/10
DRWN:SKL/M01	2007/04/12
CHKD:C/LAM	2007/04/17
APPR:K/LEE	
REV	REV

QUALITY SYMBOLS	DESCRIPTION
▽=0	
∇=0	

GENERAL TOLERANCES (UNLESS SPECIFIED)		
	mm	INCH
4 PLACES	± .005	± .0004
3 PLACES	± .008	± .0003
2 PLACES	± 0.015	± .0006
1 PLACE	± .025	± .0010
ANGULAR ± 3°		
DRAFT WHERE APPLICABLE MUST REMAIN WITHIN DIMENSIONS		

DIMENSION STYLE		SCALE	DESIGN UNITS	THIRD ANGLE PROJECTION
MM ONLY		NTS	METRIC	
DRAWN BY	DATE	TITLE		
KSEE	2003/12/17	MGRID, 2MM DUAL ROW HEADER, SMT		
CHECKED BY	DATE			
KCLING	2004/01/12			
APPROVED BY	DATE			
SKTOH	2004/01/12			
MATERIAL NO.		DOCUMENT NO.	SHEET NO.	
		SD-87759-118	2 OF 4	
SIZE	THIS DRAWING CONTAINS INFORMATION THAT IS PROPRIETARY TO MOLEX INCORPORATED AND SHOULD NOT BE USED WITHOUT WRITTEN PERMISSION			
A3				

DRAWN BY		DATE	TITLE	
KSEE		2003/12/17	MGRID, 2MM DUAL ROW HEADER, SMT	
CHECKED BY		DATE		
KCLING		2004/01/12		
APPROVED BY		DATE		
SKTOH		2004/01/12		
MATERIAL NO.		DOCUMENT NO.	SHEET NO.	
		SD-87759-118	2 OF 4	
SIZE	THIS DRAWING CONTAINS INFORMATION THAT IS PROPRIETARY TO MOLEX INCORPORATED AND SHOULD NOT BE USED WITHOUT WRITTEN PERMISSION			
A3				

9 8 7 6 5 4 3 2 1

EMBOSSED CARRIER TAPE TYPE "A"

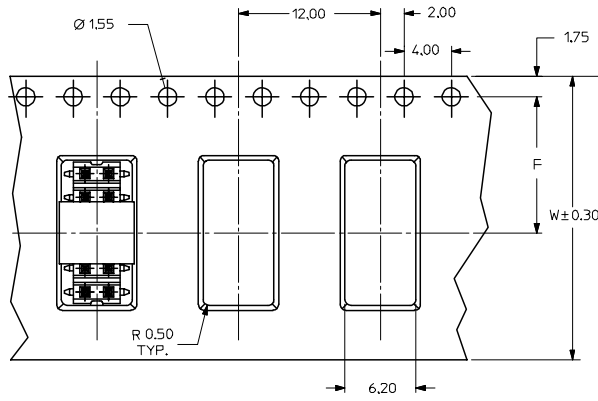
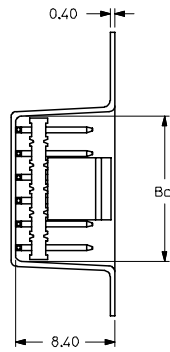

EMBOSSED CARRIER TAPE TYPE "C"

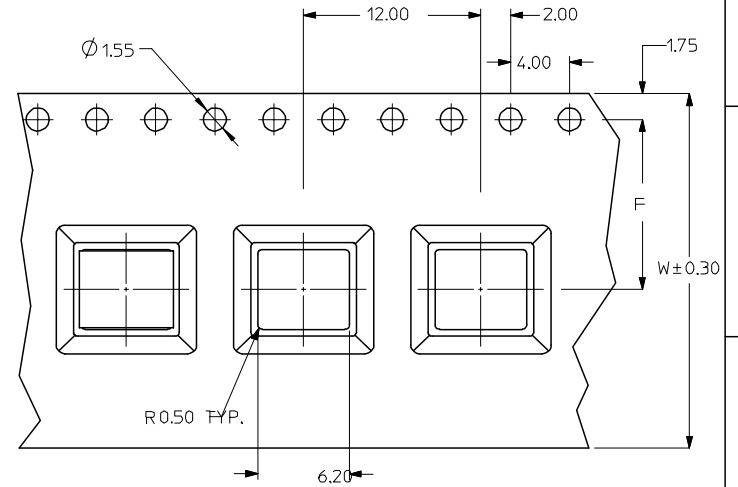
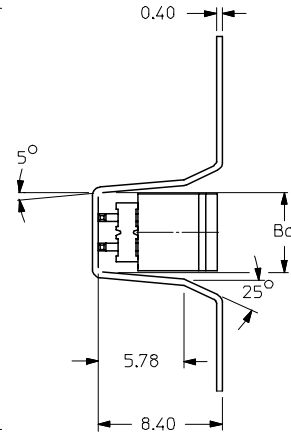

EMBOSSED CARRIER TAPE TYPE "B"

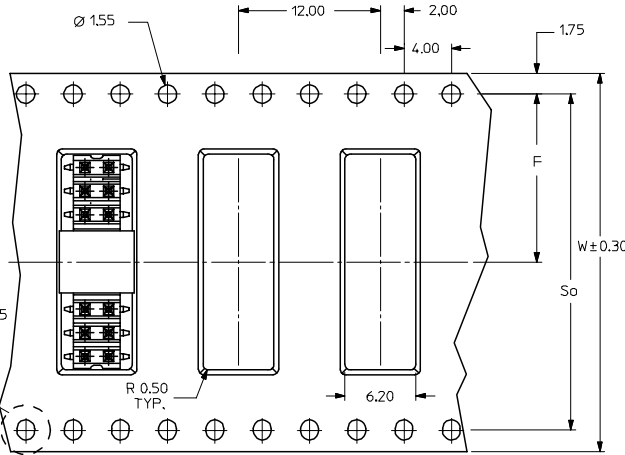
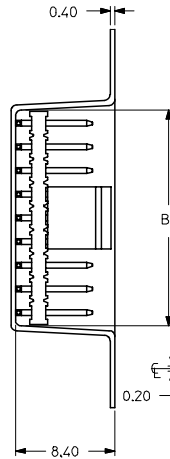

THIS TYPE OF CARRIER IS FOR CKT SIZE 8 AND BELOW.



REVISED TUBE SPEC	2007/04/10
EC NO: S2007-0829	2007/04/10
DRWN:SKL/M01	2007/04/12
CHKD:CLAM	2007/04/12
APPR:KWLEE	2007/04/17



QUALITY SYMBOLS	▽=0
	▽C=0
REV	DESCRIPTION

GENERAL TOLERANCES (UNLESS SPECIFIED)	
	mm
	INCH
4 PLACES	± 0.2
3 PLACES	± 0.2
2 PLACES	± 0.2
1 PLACE	± 0.2
ANGULAR ± 3 °	
DRAFT WHERE APPLICABLE MUST REMAIN WITHIN DIMENSIONS	

DIMENSION STYLE	
MM ONLY	
DRAWN BY	DATE
KSEE	2003/12/17
CHECKED BY	DATE
KCLING	2004/01/12
APPROVED BY	DATE
SKTOH	2004/01/12
MATERIAL NO.	
SEE TABLE	
SIZE	A3

SCALE	NTS	DESIGN UNITS	METRIC	THIRD ANGLE PROJECTION
TITLE		MGRID, 2MM DUAL ROW HEADER, SMT		
APPROVED BY		MOLEX INCORPORATED		
DOCUMENT NO.		SD-87759-118		
SHEET NO.		3 OF 4		
THIS DRAWING CONTAINS INFORMATION THAT IS PROPRIETARY TO MOLEX INCORPORATED AND SHOULD NOT BE USED WITHOUT WRITTEN PERMISSION				

	10	9	8	7	6	5	4	3	2	1	
F	PART NUMBER WITHOUT CAP IN TUBE	PART NUMBER WITH CAP IN TUBE	PART NUMBER WITH CAP IN TAPE AND REEL.	CKT SIZE	A	B	Bo	F	So	W	EMBOSSED TYPE
	87759-0415  	87759-0465	87759-0475	4	NA	2.00	5.40	11.50	-	24.00	C
	87759-0615 	87759-0665	87759-0675	6	NA	4.00	7.20	11.50	-	24.00	C
	87759-0815	87759-0865	87759-0875	8	7.90	6.00	8.20	11.50	-	24.00	C
	87759-1015	87759-1065	87759-1075	10	9.90	8.00	10.20	11.50	-	24.00	A
	87759-1215	87759-1265	87759-1275	12	11.90	10.00	12.20	11.50	-	24.00	A
	87759-1415	87759-1465	87759-1475	14	13.90	12.00	14.20	11.50	-	24.00	A
E	87759-1615	87759-1665	87759-1675	16	15.90	14.00	16.20	14.20	28.40	32.00	B
	87759-1815	87759-1865	87759-1875	18	17.90	16.00	18.20	14.20	28.40	32.00	B
	87759-2015	87759-2065	87759-2075	20	19.90	18.00	20.20	14.20	28.40	32.00	B
	87759-2215	87759-2265	87759-2275	22	21.90	20.00	22.20	20.20	40.40	44.00	B
	87759-2415	87759-2465	87759-2475	24	23.90	22.00	24.20	20.20	40.40	44.00	B
	87759-2615	87759-2665	87759-2675	26	25.90	24.00	26.20	20.20	40.40	44.00	B
D	87759-2815	87759-2865	87759-2875	28	27.90	26.00	28.20	20.20	40.40	44.00	B
	87759-3015	87759-3065	87759-3075	30	29.90	28.00	30.20	20.20	40.40	44.00	B
	87759-3215	87759-3265	87759-3275	32	31.90	30.00	32.20	20.20	40.40	44.00	B
	87759-3415	87759-3465	87759-3475	34	33.90	32.00	34.20	26.20	52.40	56.00	B
	87759-3615	87759-3665	87759-3675	36	35.90	34.00	36.20	26.20	52.40	56.00	B
	87759-3815	87759-3865	87759-3875	38	37.90	36.00	38.20	26.20	52.40	56.00	B
C	87759-4015	87759-4065	87759-4075	40	39.90	38.00	40.20	26.20	52.40	56.00	B
	87759-4215	87759-4265	87759-4275	42	41.90	40.00	42.20	26.20	52.40	56.00	B
	87759-4415	87759-4465	87759-4475	44	43.90	42.00	44.20	26.20	52.40	56.00	B
	87759-4615	87759-4665	87759-4675	46	45.90	44.00	46.20	26.20	52.40	56.00	B
	87759-4815	87759-4865	87759-4875	48	47.90	46.00	48.20	26.20	52.40	56.00	B
	87759-5015	87759-5065	87759-5075	50	49.90	48.00	50.20	34.20	68.40	72.00	B

REVISED TUBE SPEC EC NO: S2007-0829 DRWNS:KLI M01 2007/04/10 CHKD:CWAM 2007/04/12 APPR:KWLEE 2007/04/17	DESCRIPTION REV	QUALITY SYMBOLS  =0  =0	GENERAL TOLERANCES (UNLESS SPECIFIED)	DIMENSION STYLE MM ONLY	SCALE NTS	DESIGN UNITS METRIC	THIRD ANGLE PROJECTION																											
				<table border="1"> <tr> <th></th> <th>mm</th> <th>INCH</th> </tr> <tr> <td>4 PLACES</td> <td>± ---</td> <td>± ---</td> </tr> <tr> <td>3 PLACES</td> <td>± ---</td> <td>± ---</td> </tr> <tr> <td>2 PLACES</td> <td>± 0.2</td> <td>± ---</td> </tr> <tr> <td>1 PLACE</td> <td>± ---</td> <td>± ---</td> </tr> </table>		mm	INCH	4 PLACES	± ---	± ---	3 PLACES	± ---	± ---	2 PLACES	± 0.2	± ---	1 PLACE	± ---	± ---	<table border="1"> <tr> <th>DRAWN BY</th> <th>DATE</th> <th>TITLE</th> </tr> <tr> <td>KSEE</td> <td>2003/12/17</td> <td rowspan="2">MGRID, 2MM DUAL ROW HEADER, SMT</td> </tr> <tr> <th>CHECKED BY</th> <th>DATE</th> </tr> <tr> <td>KCLING</td> <td>2004/01/12</td> <td></td> </tr> </table>	DRAWN BY	DATE	TITLE	KSEE	2003/12/17	MGRID, 2MM DUAL ROW HEADER, SMT	CHECKED BY	DATE	KCLING	2004/01/12				
			mm	INCH																														
		4 PLACES	± ---	± ---																														
3 PLACES	± ---	± ---																																
2 PLACES	± 0.2	± ---																																
1 PLACE	± ---	± ---																																
DRAWN BY	DATE	TITLE																																
KSEE	2003/12/17	MGRID, 2MM DUAL ROW HEADER, SMT																																
CHECKED BY	DATE																																	
KCLING	2004/01/12																																	
			ANGULAR ± 3 °	<table border="1"> <tr> <th>APPROVED BY</th> <th>DATE</th> </tr> <tr> <td>SKTOH</td> <td>2004/01/12</td> </tr> </table>	APPROVED BY	DATE	SKTOH	2004/01/12	 MOLEX INCORPORATED																									
APPROVED BY	DATE																																	
SKTOH	2004/01/12																																	
			DRAFT WHERE APPLICABLE MUST REMAIN WITHIN DIMENSIONS	SEE TABLE		SD-87759-118	SHEET NO. 4 OF 4																											