

# Micropower Precision Triple Supply Monitor with Push-Pull Reset Output in a 5-Lead SOT-23 Package

## FEATURES

- **Monitors Three Inputs Simultaneously: 3V, 1.8V and Adjustable**
- **±1.5% Threshold Accuracy Over Temperature**
- **Very Low Supply Current: 10 $\mu$ A Typ**
- 200ms Reset Time Delay
- Power Supply Glitch Immunity
- Guaranteed  $\overline{\text{RESET}}$  for  $V_{\text{CC3}} \geq 1\text{V}$  or  $V_{\text{CC18}} \geq 1\text{V}$
- **3V Active-Low Push-Pull Reset Output**
- 5-Lead SOT-23 Package

## APPLICATIONS

- Desktop Computers
- Notebook Computers
- Intelligent Instruments
- Portable Battery-Powered Equipment
- Network Servers

## DESCRIPTION

The LTC<sup>®</sup>1985-1.8 is a triple supply monitor intended for systems with multiple supply voltages. The reset output remains low until all three supplies have been in compliance for 200ms. Tight 1.5% accuracy specifications and glitch immunity ensure reliable reset operation without false triggering.

The  $\overline{\text{RST}}$  output is guaranteed to be in the correct state for  $V_{\text{CC18}}$  or  $V_{\text{CC3}}$  down to 1V. The LTC1985 may also be configured to monitor any one or two  $V_{\text{CC}}$  inputs instead of three, depending on system requirements.

Very low (10 $\mu$ A typical) supply current makes the LTC1985 ideal for power conscious systems.

The LTC1985 is available in a 5-lead SOT-23 package.

 LTC and LT are registered trademarks of Linear Technology Corporation.

## TYPICAL APPLICATION

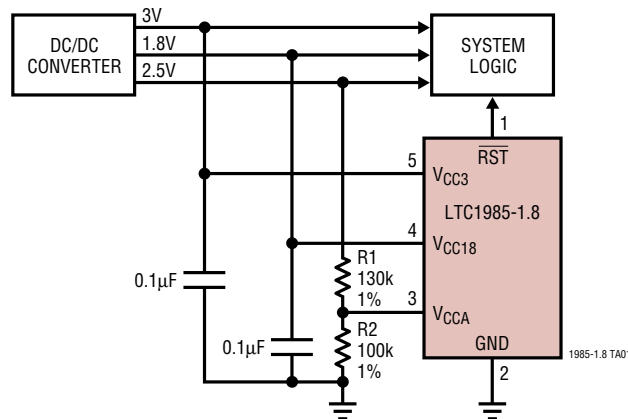

## ABSOLUTE MAXIMUM RATINGS

(Notes 1, 2)

$V_{CC3}$ , $V_{CC18}$ , $V_{CCA}$ .....	-0.3V to 7V
$\overline{RST}$ .....	-0.3V to ( $V_{CC3} + 0.3V$ )
Operating Temperature Range (Note 3) .....	-40°C to 85°C
Storage Temperature Range .....	-65°C to 150°C
Lead Temperature (Soldering, 10 sec) .....	300°C

## PACKAGE/ORDER INFORMATION

<p>TOP VIEW</p> <p>S5 PACKAGE 5-LEAD PLASTIC SOT-23 <math>T_{JMAX} = 125^{\circ}C</math>, <math>\theta_{JA} = 250^{\circ}C/W</math></p>	ORDER PART NUMBER
	LTC1985ES5-1.8
	S5 PART MARKING
	LTNM

Consult factory for Industrial and Military grade parts.

## ELECTRICAL CHARACTERISTICS

The ● denotes specifications which apply over the full operating temperature range, otherwise specifications are at  $T_A = 25^{\circ}C$ .  $V_{CC3} = 3V$ ,  $V_{CC18} = 1.8V$ ,  $V_{CCA} = V_{CC3}$  unless otherwise noted.

SYMBOL	PARAMETER	CONDITIONS	MIN	TYP	MAX	UNITS
$V_{RT3}$	Reset Threshold $V_{CC3}$	$V_{CC3}$ Input Threshold	● 2.760	2.805	2.850	V
$V_{RT18}$	Reset Threshold $V_{CC18}$	$V_{CC18}$ Input Threshold	● 1.656	1.683	1.710	V
$V_{RTA}$	Reset Threshold $V_{CCA}$	$V_{CCA}$ Input Threshold	● 0.985	1.000	1.015	V
$V_{CCOP}$	$V_{CC3}$ , $V_{CC18}$ Operating Voltage	$\overline{RST}$ in Correct Logic State	● 1		7	V
$I_{VCC3}$	$V_{CC3}$ Supply Current	$V_{CC18} > V_{CC3}$ $V_{CC18} < V_{CC3}$ , $V_{CC3} = 3V$ (Note 4)	●	1 10	2 20	$\mu A$ $\mu A$
$I_{VCC18}$	$V_{CC18}$ Supply Current	$V_{CC18} < V_{CC3}$ , $V_{CC18} = 1.8V$ (Note 4)	●	1	2	$\mu A$
$I_{VCCA}$	$V_{CCA}$ Input Current	$V_{CCA} = 1V$	● -15	0	15	nA
$t_{RST}$	Reset Pulse Width	$\overline{RST}$ Low (Note 5)	● 140	200	280	ms
$t_{UV}$	$V_{CC}$ Undervoltage Detect to $\overline{RST}$	$V_{CC18}$ , $V_{CC3}$ or $V_{CCA}$ Less Than Reset (Note 5) Threshold $V_{RT}$ by More Than 1%		110		$\mu s$
$V_{OL}$	Output Voltage Low, $\overline{RST}$	$I_{SINK} = 2.5mA$ , $V_{CC3} = 3V$ , $V_{CC18} = 0V$ $I_{SINK} = 100\mu A$ , $V_{CC3} = 1V$ , $V_{CC18} = 0V$ $I_{SINK} = 100\mu A$ , $V_{CC3} = 0V$ , $V_{CC18} = 1V$ $I_{SINK} = 100\mu A$ , $V_{CC3} = 1V$ , $V_{CC18} = 1V$	●	0.15 0.05 0.05 0.05	0.4 0.3 0.3 0.3	V V V V
$V_{OH}$	Output Voltage High, $\overline{RST}$	$I_{SOURCE} = 200\mu A$	● 0.8	$V_{CC3}$		V

**Note 1:** Absolute Maximum Ratings are those values beyond which the life of the device may be impaired.

**Note 2:** All voltage values are with respect to GND.

**Note 3:** The LTC1985E is guaranteed to meet specified performance from 0°C to 70°C and is designed, characterized and assured to meet the

extended temperature limits of -40°C to 85°C but are not tested at these temperatures.

**Note 4:** Both  $V_{CC3}$  and  $V_{CC18}$  can act as the supply depending on which pin has the greatest potential.

**Note 5:** Measured from when input passes through the input threshold voltage ( $V_{RTX}$ ) until  $\overline{RST}$  passes through 1.5V.

# TYPICAL PERFORMANCE CHARACTERISTICS

**I<sub>VCC3</sub> vs Temperature**

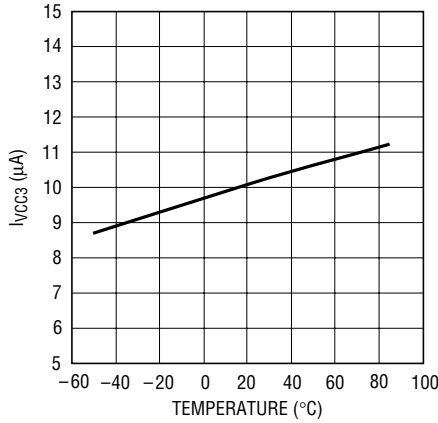

1985-18 G01

**I<sub>VCC18</sub> vs Temperature**

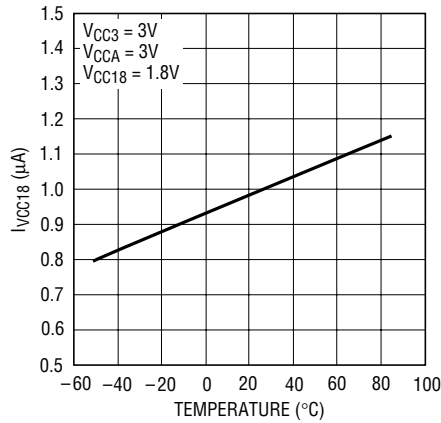

1985-18 G02

**V<sub>CCA</sub> Input Current vs Input Voltage**

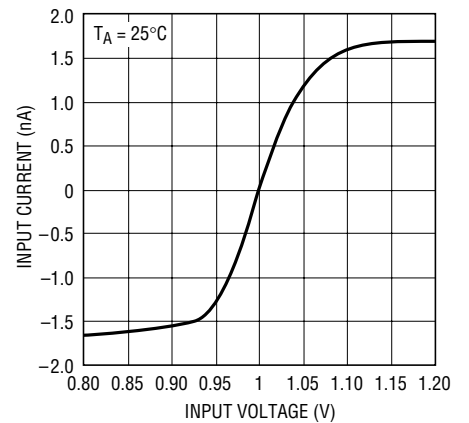

1985-18 G03

**V<sub>CCA</sub> Threshold Voltage vs Temperature**

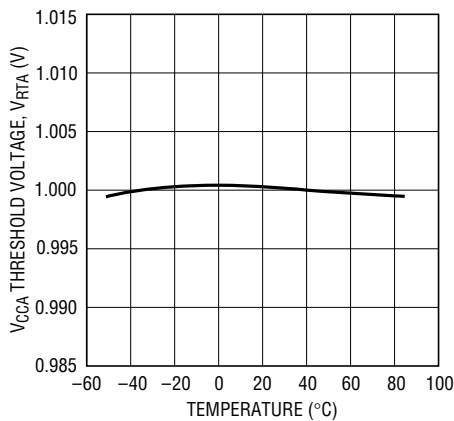

1985-18 G04

**V<sub>CC3</sub> Threshold Voltage vs Temperature**

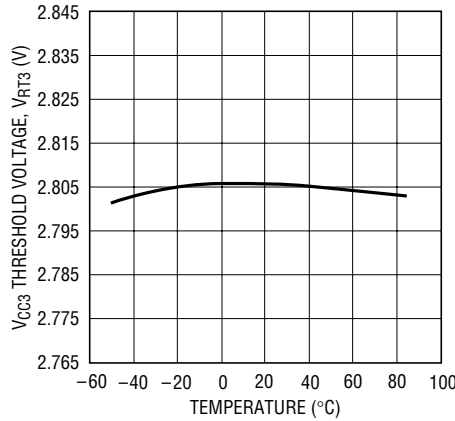

1985-18 G05

**V<sub>CC18</sub> Threshold Voltage vs Temperature**

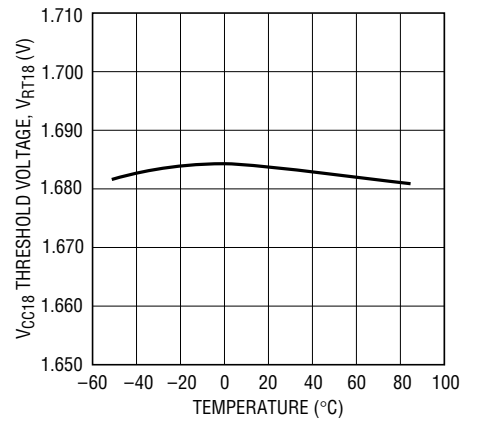

1985-18 G06

**Typical Transient Duration vs Comparator Overdrive**

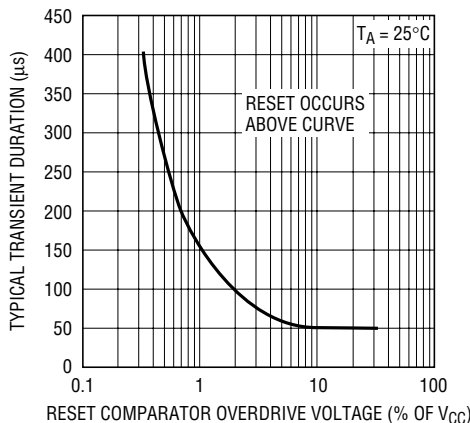

1985-18 G07

**Reset Pulse Width vs Temperature**

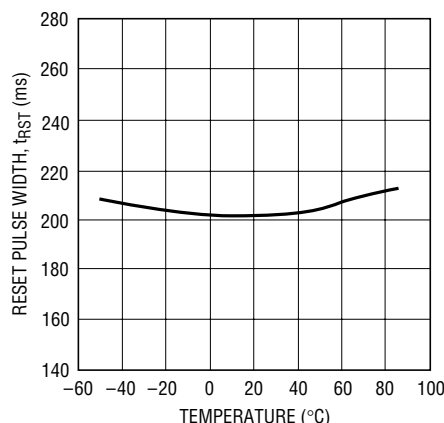

1985-18 G08

**I<sub>SINK</sub> vs Supply Voltage**

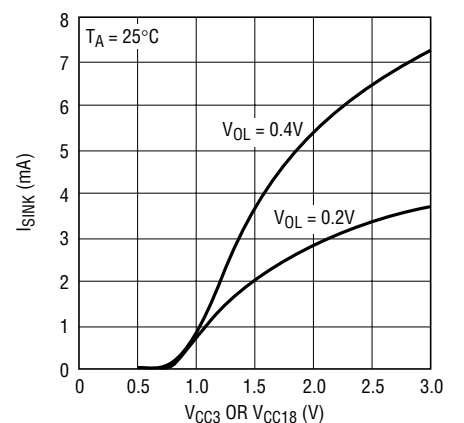

1985-18 • G09

## TYPICAL PERFORMANCE CHARACTERISTICS

**RST High Level Output Voltage vs Output Source Current**

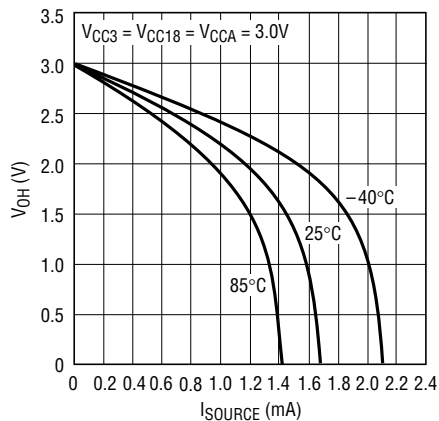

1985-81 G10

**RST Voltage Output Low vs Output Sink Current**

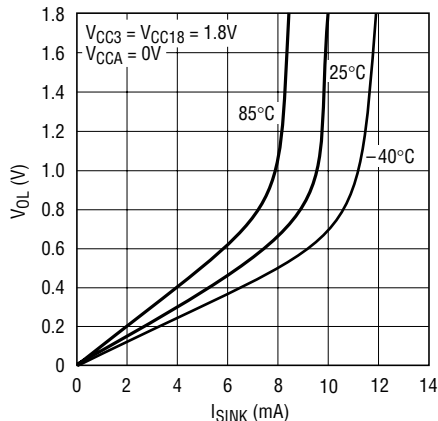

1985-81 G11

**RST Voltage Output Low vs Output Sink Current**

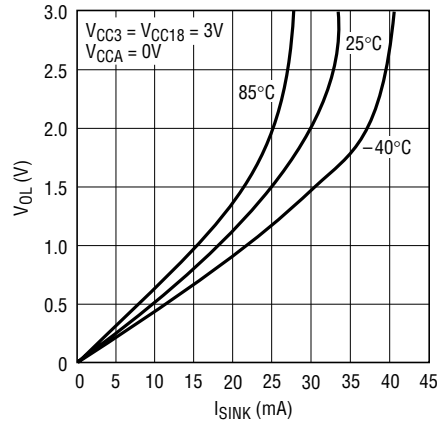

1985-81 G12

## PIN FUNCTIONS

**RST (Pin 1):** Reset Logic Output. Active low, 3V push-pull output. Asserted when one or all of the supplies are below trip thresholds and held for 200ms after all supplies become valid.

**GND (Pin 2):** Ground.

**V<sub>CCA</sub> (Pin 3):** 1V Sense, High Impedance Input. If unused it can be tied to either V<sub>CC3</sub> or V<sub>CC18</sub>.

**V<sub>CC18</sub> (Pin 4):** 1.8V Sense Input and Power Supply Pin. This pin is used on the LTC1985 to provide power to the part when the voltage on V<sub>CC18</sub> is greater than the voltage on V<sub>CC3</sub>. Bypass to ground with a  $\geq 0.1\mu F$  ceramic capacitor.

**V<sub>CC3</sub> (Pin 5):** 3V Sense Input and Power Supply Pin. This pin provides power to the part when the voltage on V<sub>CC3</sub> is greater than the voltage on V<sub>CC18</sub>. Bypass to ground with a  $\geq 0.1\mu F$  ceramic capacitor.

# BLOCK DIAGRAM

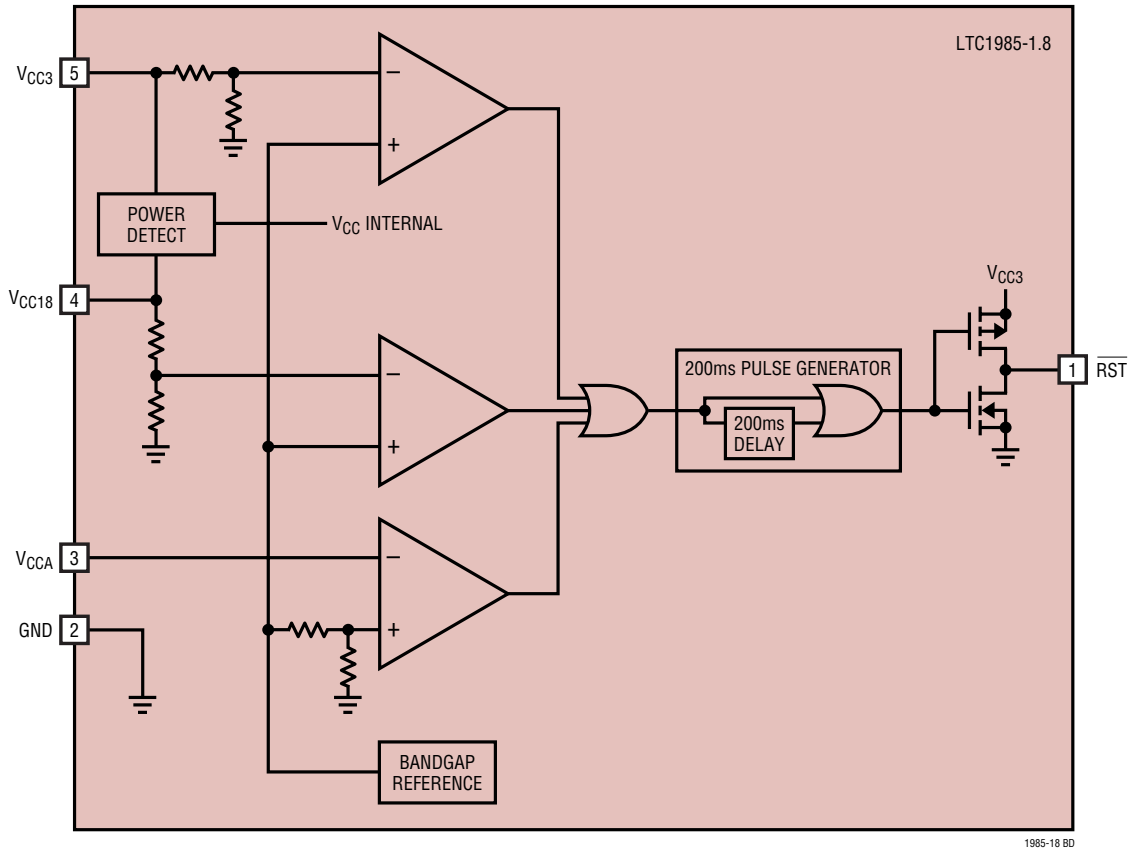

1985-18 BD

# TIMING DIAGRAM

VCC Monitor Timing

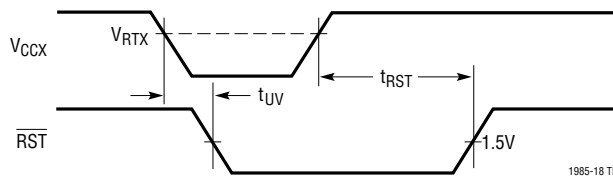

1985-18 TD

## APPLICATIONS INFORMATION

### Supply Monitoring

The LTC1985 is a low power, high accuracy triple supply monitoring circuit with a single 200ms microprocessor reset output.

All three  $V_{CC}$  inputs must be above predetermined thresholds for reset not to be invoked. The LTC1985 will assert reset during power-up, power-down and brownout conditions on any one or all of the  $V_{CC}$  inputs.

### 3V or 1.8V Power Detect

The LTC1985 is powered from the 3V input pin ( $V_{CC3}$ ) or the 1.8V input pin ( $V_{CC18}$ ), whichever pin has the highest potential. This ensures the part pulls the  $\overline{RST}$  pin low as soon as either input pin is  $\geq 1V$ .

### Power-Up

Upon power-up, either the  $V_{CC18}$  or  $V_{CC3}$  pin, can power the part. This ensures that  $\overline{RST}$  will be low when either  $V_{CC18}$  or  $V_{CC3}$  reaches 1V. As long as any one of the  $V_{CC}$  inputs is below its predetermined threshold,  $\overline{RST}$  will stay a logic low. Once all of the  $V_{CC}$  inputs rise above their thresholds, an internal timer is started and  $\overline{RST}$  is driven high after 200ms.

$\overline{RST}$  is reasserted whenever any one of the  $V_{CC}$  inputs drops below its predetermined threshold and remains asserted until 200ms after all of the  $V_{CC}$  inputs are above their thresholds.

### Power-Down

On power-down, once any of the  $V_{CC}$  inputs drop below its threshold,  $\overline{RST}$  is held at a logic low. A logic low of 0.3V is guaranteed until both  $V_{CC3}$  and  $V_{CC18}$  drop below 1V.

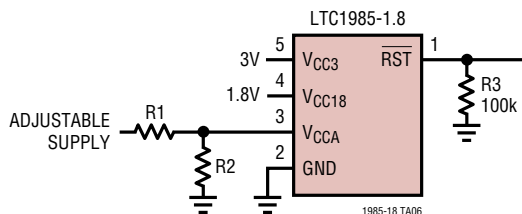

Figure 1. Typical Application Showing Resistor on  $\overline{RST}$  Output to Ground

### Override Functions

The  $V_{CCA}$  pin, if unused, can be tied to either  $V_{CC3}$  or  $V_{CC18}$ . This is an obvious solution since the trip points for  $V_{CC3}$  and  $V_{CC18}$  will always be greater than the trip point for  $V_{CCA}$ . Likewise, the  $V_{CC18}$ , if unused, can be tied to  $V_{CC3}$ .  $V_{CC3}$  must always be used. Tying  $V_{CC3}$  to  $V_{CC18}$  and operating off of a 1.8V supply will result in the continuous assertion of  $\overline{RST}$ .

### Ensuring $\overline{RST}$ Valid for Supply Voltages Under 1V

When the supplies drops below 1V the  $\overline{RST}$  output current sink capability is drastically reduced. The combination of stray currents and stray capacitance to signals other than ground can cause the  $\overline{RST}$  output pin to float around. In a lot of applications this is not a problem since most microprocessors and other circuits do not operate with the supply voltage less than 1V. In applications where the  $\overline{RST}$  output must be valid down to 0V the addition of a pull-down resistor from  $\overline{RST}$  to ground will ensure  $\overline{RST}$  is held low. The circuit in Figure 1 shows an application employing this technique. The value chosen for the pull-down resistor ( $R3$ ) is a trade-off between pull-down strength and loading of the  $\overline{RST}$  pin. If the value of the resistor is too large the pin may still float and if the resistor value is too low it may load down the  $\overline{RST}$  as well as burn excess supply current, a value of 100k is a good compromise.

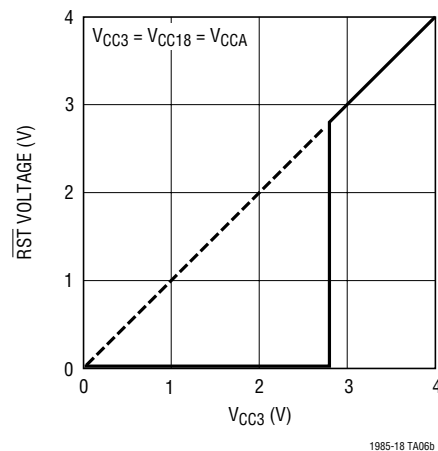
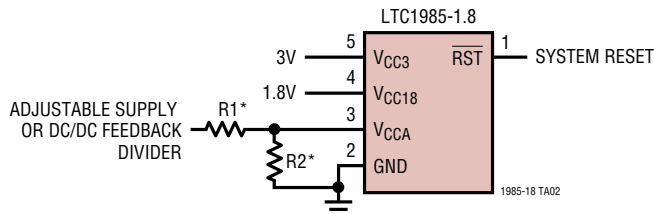

Figure 2.  $\overline{RST}$  Voltage vs  $V_{CC3}$  with a 100k Resistor on  $\overline{RST}$  to Ground

# TYPICAL APPLICATIONS

**Triple Supply Monitor (3V, 1.8V and Adjustable)**



\*TO PRESERVE THRESHOLD ACCURACY, SET PARALLEL COMBINATION OF R1 AND R2  $\leq 66.5k$

**Dual Supply Monitor (3V and 1.8V, Defeat VCCA Input)**

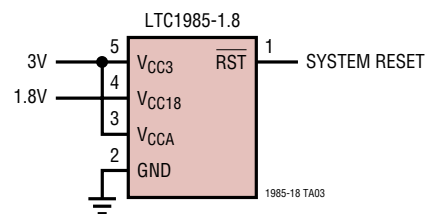

**Dual Supply Monitor (3V Plus Adjustable)**

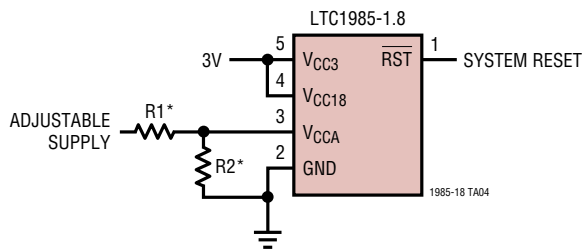

\*TO PRESERVE THRESHOLD ACCURACY, SET PARALLEL COMBINATION OF R1 AND R2  $\leq 66.5k$

**Using VCCA Tied to DC/DC Feedback Divider**

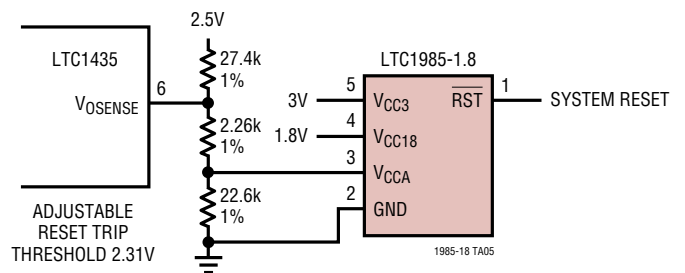

# TYPICAL APPLICATION

## Triple Supply Monitor with Manual Reset Button

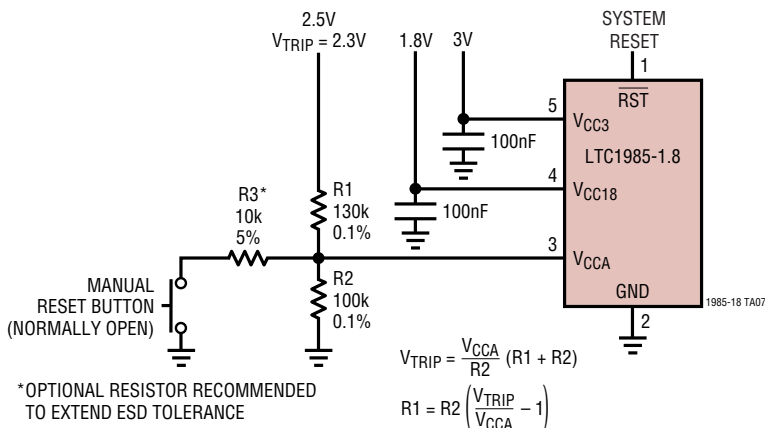

# PACKAGE DESCRIPTION

Dimensions in inches (millimeters) unless otherwise noted.

## S5 Package 5-Lead Plastic SOT-23 (LTC DWG # 05-08-1633)

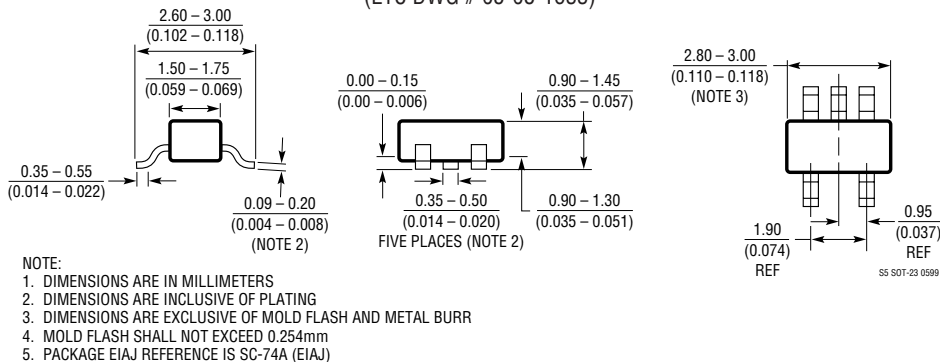

# RELATED PARTS

PART NUMBER	DESCRIPTION	COMMENTS
LTC690	5V Supply Monitor, Watchdog Timer and Battery Backup	4.65V Threshold
LTC694-3.3	3.3V Supply Monitor, Watchdog Timer and Battery Backup	2.9V Threshold
LTC699	5V Supply Monitor and Watchdog Timer	4.65V Threshold
LTC1232	5V Supply Monitor, Watchdog Timer and Push-Button Reset	4.37V/4.62V Threshold
LTC1326	Micropower Precision Triple Supply Monitor for 5V, 3.3V and ADJ	4.725V, 3.118V, 1V Thresholds (±0.75%)
LTC1326-2.5	Micropower Precision Triple Supply Monitor for 2.5V, 3.3V and ADJ	2.363V, 3.118V, 1V Thresholds (±0.75%)
LTC1536	Precision Triple Supply Monitor for PCI Applications	Meets PCI t <sub>FAIL</sub> Timing Specifications
LTC1726-2.5	Micropower Triple Supply Monitor for 2.5V, 3.3V and ADJ	Adjustable $\overline{\text{RESET}}$ and Watchdog Time Outs
LTC1726-5	Micropower Triple Supply Monitor for 5V, 3.3V and ADJ	Adjustable $\overline{\text{RESET}}$ and Watchdog Time Outs
LTC1727-2.5/1727-5	Micropower Triple Supply Monitor with Open-Drain Reset	Individual Monitor Outputs in MSOP
LTC1728-1.8	Micropower Triple Supply Monitor with Open-Drain Reset	5-Lead SOT-23 Package
LTC1728-2.5/1728-5	Micropower Triple Supply Monitor with Open-Drain Reset	5-Lead SOT-23 Package