

## Round Type, Bi-color LED lamp

BL-L819

### Features:

- 8.0mm Round Type BI-COLOR LED Lamps, with 3 leads
- Ultra brightness.
- Choice of various viewing angles.
- Diffused, Transparent and Water clear lens are available.
- IC compatible /Low current capability.
- RoHs Compliance



### ■ Electrical-optical characteristics: (Ta=25°C) (Test Condition: IF=20mA)

Part Number	Chip			Lens Type	Forward Voltage(VF) Unit:V		Luminous Intensity (Iv) Unit:mcd		Viewing Angle 2?1/2(deg)
	Emitted Color	Material	λ <sub>P</sub> (nm)		Typ	Max	Min.	Typ	
					Orange	GaAsP/GaP	635	2.10	
BL-L819EGW	Green	GaP/GaP	570	Water Diff.	2.20	2.50	5	12	60
	Yellow	GaAsP/GaP	585		2.10	2.50	5	12	
BL-L819YGW	Green	GaP/GaP	570		2.20	2.50	5	12	
	Ultra Yellow	AlGaInP	630		2.10	2.50	80	100	
BL-L819UEUGW	Ultra Green	AlGaInP	574		2.20	2.50	60	80	

### ■ Absolute maximum ratings (Ta=25°C)

Parameter	E	UE	Y	G	UG	Unit
Forward Current I <sub>F</sub>	25	30	25	30	30	mA
Power Dissipation P <sub>d</sub>	60	65	60	65	75	mW
Reverse Voltage V <sub>R</sub>	5	5	5	5	5	V
Peak Forward Current I <sub>PF</sub> (Duty 1/10 @1KHZ)	150	150	150	150	150	mA
Operation Temperature T <sub>OPR</sub>	-40 to +80					°C
Storage Temperature T <sub>STG</sub>	-40 to +85					°C
Lead Soldering Temperature T <sub>SOL</sub>	Max.260±5°C for 3 sec Max. (1.6mm from the base of the epoxy bulb)					°C

## Round Type, Bi-color LED lamp

BL-L819

### ■ Package configuration & Internal circuit diagram

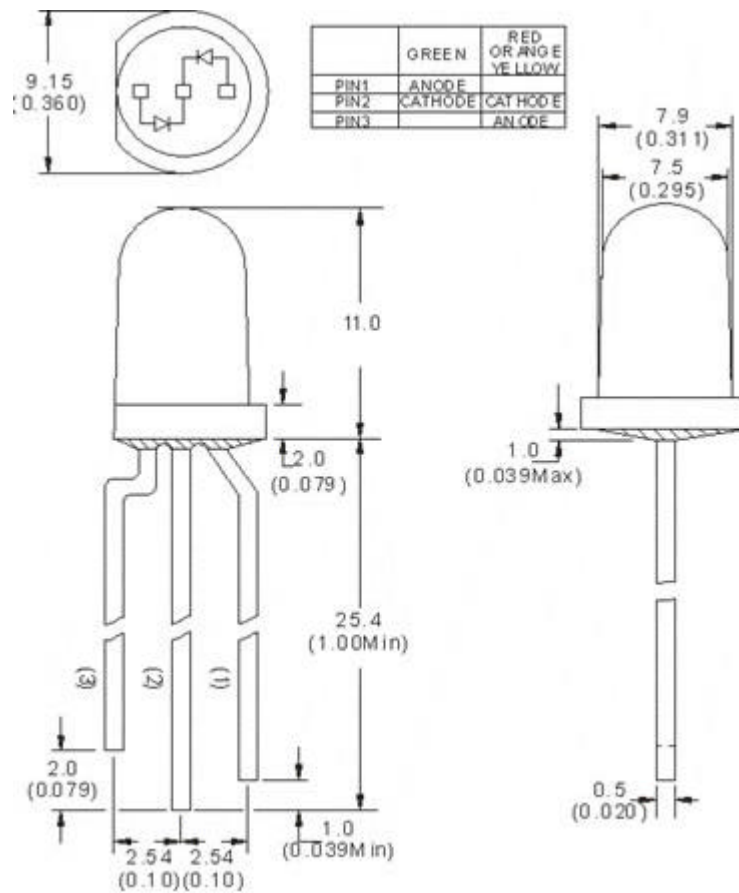

#### Notes:

1. All dimensions are in millimeters (inches)
2. Tolerance is  $\pm 0.25(0.01)$  unless otherwise noted.
3. Specifications are subject to change without notice.

# Round Type, Bi-color LED lamp

**BL-L819**

## Typical electrical-optical characteristics curves:

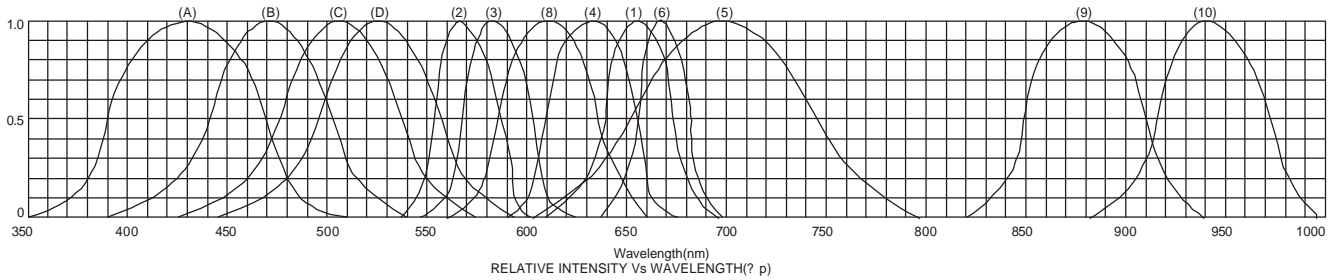

- (1) - GaAsP/GaAs 655nm/Red
- (2) - GaP 570nm/Yellow Green
- (3) - GaAsP/GaP 585nm/Yellow
- (4) - GaAsP/GaP 635nm/Orange & Hi-Eff Red
- (5) - GaP 700nm/Bright Red
- (6) - GaAlAs/GaAs 660nm/Super Red
- (8) - GaAsP/GaP 610nm/Super Red
- (9) - GaAlAs 880nm
- (10) - GaAs/GaAs & GaAlAs/GaAs 940nm
- (A) - GaN/SiC 430nm/Blue
- (B) - InGaN/SiC 470nm/Blue
- (C) - InGaN/SiC 505nm/Ultra Green
- (D) - InGaAl/SiC 525nm/Ultra Green

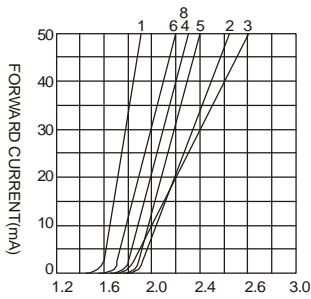

FORWARD VOLTAGE (Vf)  
FORWARD CURRENT VS.  
FORWARD VOLTAGE

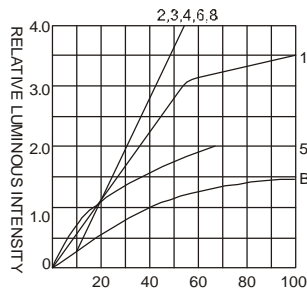

FORWARD CURRENT (mA)  
RELATIVE LUMINOUS  
INTENSITY VS. FORWARD  
CURRENT

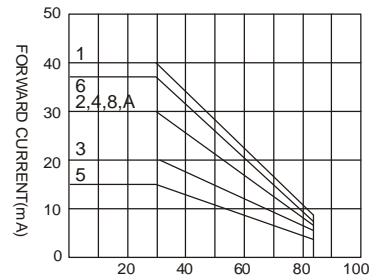

AMBIENT TEMPERATURE Ta( °C )  
FORWARD CURRENT VS. AMBIENT  
TEMPERATURE

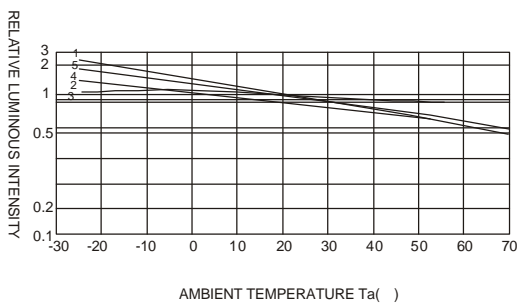

AMBIENT TEMPERATURE Ta( °C )

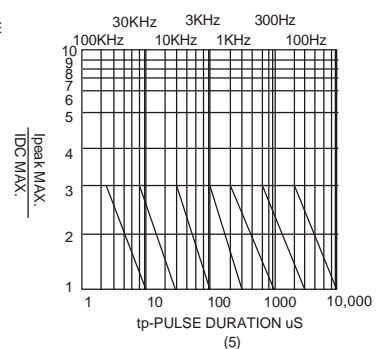
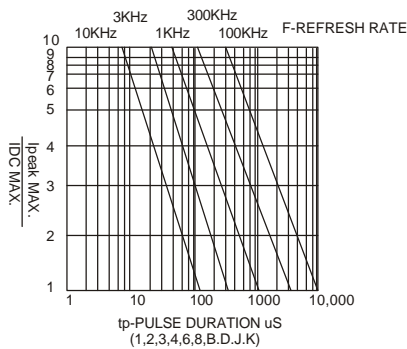

NOTE:25 free air temperature unless otherwise specified

Round Type, Bi-color LED lamp

BL-L819

■ Packing and weighting

