

### Features

- Current rating up to 5 A
- Inductance range: 0.60 to 6.0  $\mu$ H
- Frequency range to 1200 MHz
- RoHS compliant\*

### Applications

- EMI suppression

## SRF0504 Series - Line Filter

### Electrical Specifications @ 25 °C

Part Number	L ( $\mu$ H) ** (Ref.)	Impedance*** Z ( $\Omega$ ) @ 100 MHz	DCR (m $\Omega$ ) max. (each winding)	Rated Current (mA)
SRF0504-191Y	0.60	190 $\pm$ 35 %	20	5000
SRF0504-351Y	1.1	350 $\pm$ 35 %	40	2000
SRF0504-102Y	2.7	1000 $\pm$ 35 %	60	1500
SRF0504-152Y	3.6	1500 $\pm$ 35 %	100	1000
SRF0504-302Y	6.0	3000 $\pm$ 50 %	200	500
SRF0504-402Y	2.8	4000 $\pm$ 50 %	300	200

\*\* Test condition: 100 KHz, 0.1 V  
 \*\*\* At 20 °C.

### General Specifications

Rated Voltage ..... 50 Vdc  
 Dielectric Withstanding Voltage .. 125 Vdc  
 Temperature Rise.. 20 °C at rated current  
 Operating Temperature  
 ..... -40 °C to +125 °C  
 (Temperature rise included)  
 Storage Temperature .. -40 °C to +125 °C  
 Solderability ..... 250 °C for 5 sec.  
 (JEDEC J-STD-020D)

### Materials

Core Material ..... Ferrite  
 Wire ..... Enameled copper  
 Terminal coating ..... Sn  
 Packaging ..... 1000 pcs. per 13-inch reel

### Schematic

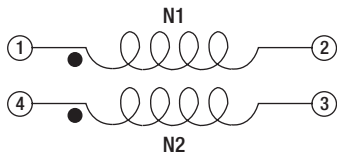

### Typical Part Marking

SRF0504-191Y ~ SRF0504-302Y

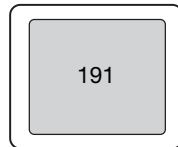

SRF0504-402Y



### How to Order

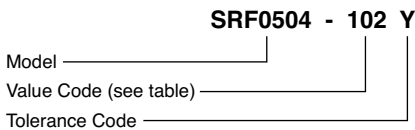

### Product Dimensions

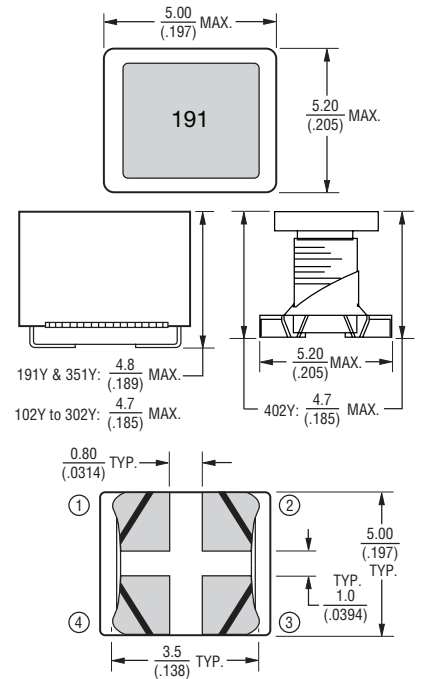

### Impedance Graphs (Continued on page 2)

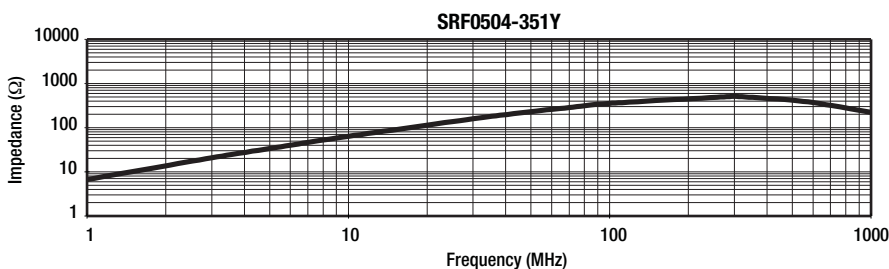
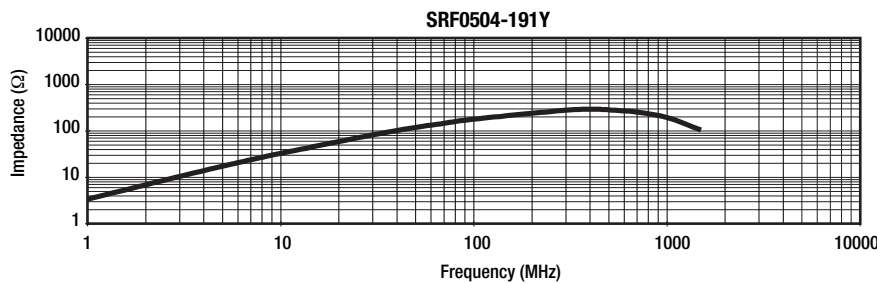

### Recommended Layout

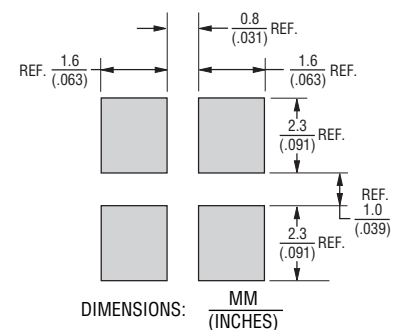

\*RoHS Directive 2002/95/EC Jan. 27, 2003 including annex and RoHS Recast 2011/65/EU June 8, 2011. Specifications are subject to change without notice. Customers should verify actual device performance in their specific applications.

# SRF0504 Series - Line Filter

**BOURNS®**

## Impedance Graphs (Continued)

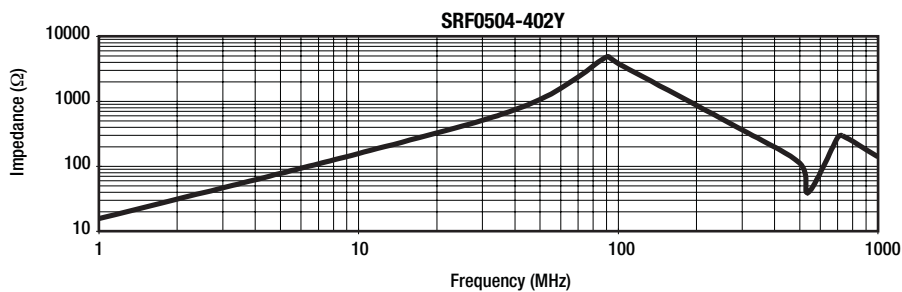
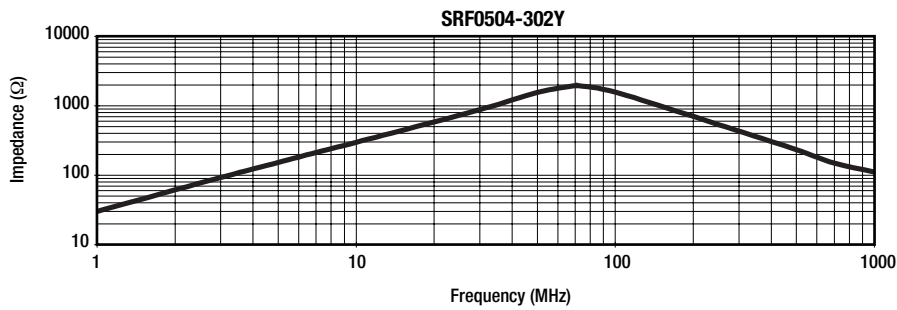
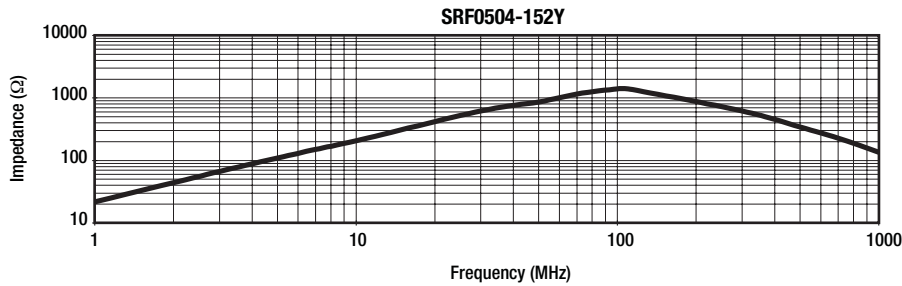
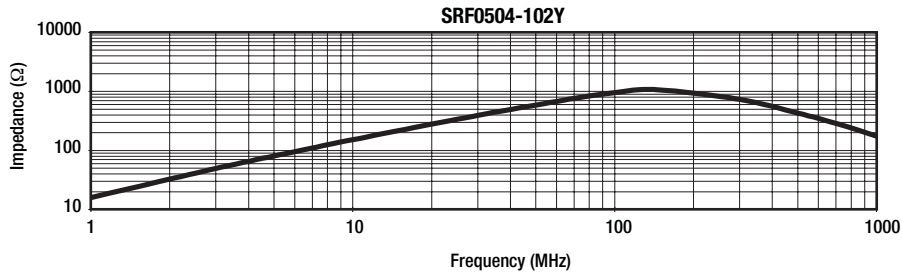

# SRF0504 Series - Line Filter

**BOURNS®**

## Packaging Specifications

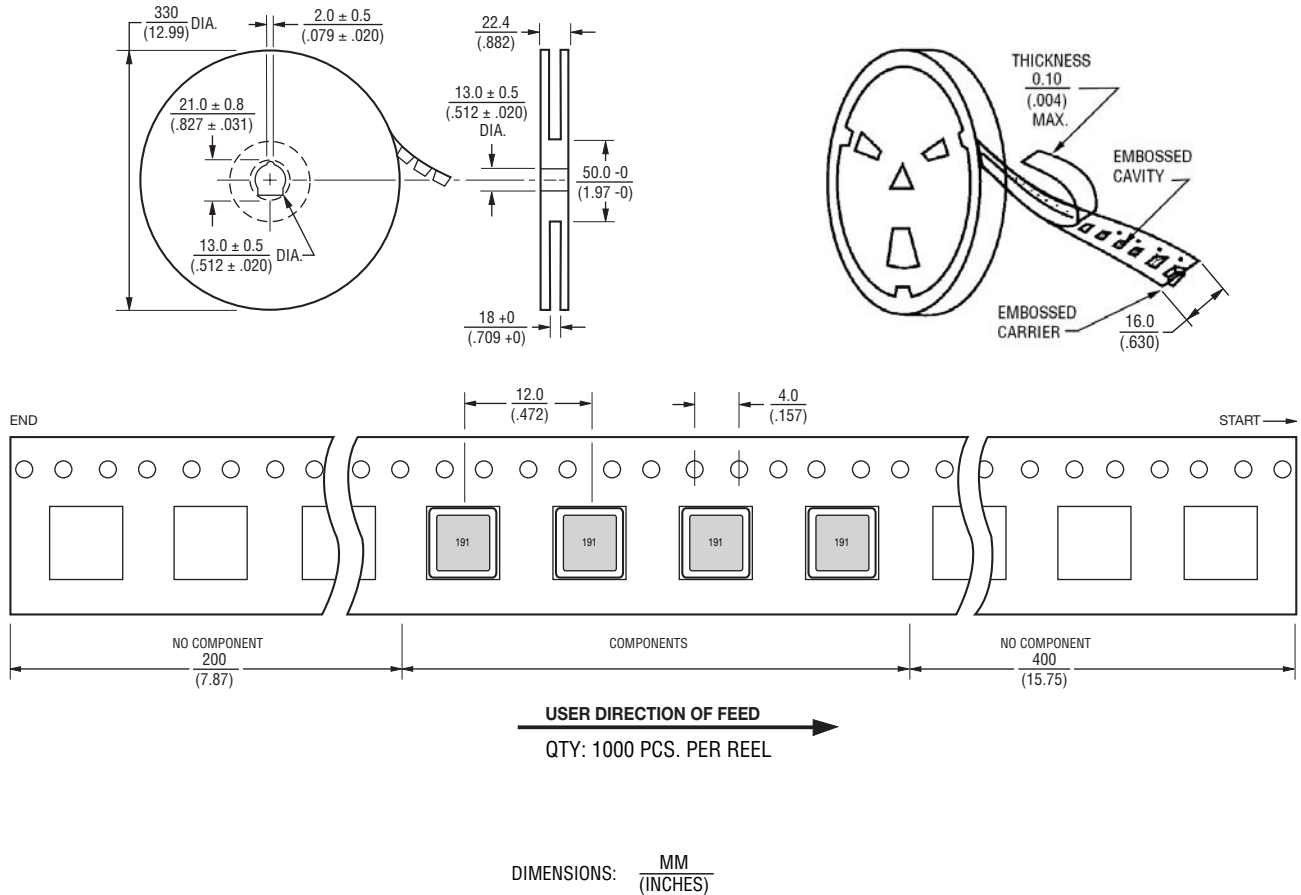

**BOURNS®**

**Asia-Pacific:** Tel: +886-2 2562-4117 • Fax: +886-2 2562-4116

**Europe:** Tel: +41-41 768 5555 • Fax: +41-41 768 5510

**The Americas:** Tel: +1-951 781-5500 • Fax: +1-951 781-5700

[www.bourns.com](http://www.bourns.com)

REV. 02/12

Specifications are subject to change without notice.

Customers should verify actual device performance in their specific applications.