

MBRF20100CT

Rev.F Mar.-2016

描述 / Descriptions

TO-220F 塑料封装 肖特基二极管。

Schottky Barrier Diode in a TO-220F Plastic Package.

特征 / Features

损耗低，效率高。

Low power loss,high efficiency.

用途 / Applications

用于高频、低压、大电流整流二极管，续流二极管，保护二极管。

For use in low voltage,high frequency inverters, free wheeling, and polarity protection applications.

内部等效电路 / Equivalent Circuit

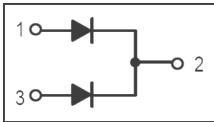

引脚排列 / Pinning

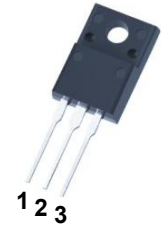

PIN1 : Anode PIN 2 : Cathode PIN 3 : Anode

放大及印章代码 / h_{FE} Classifications & Marking

见印章说明。 See Marking Instructions

极限参数 / Absolute Maximum Ratings(Ta=25°C)

参数 Parameter	符号 Symbol	数值 Rating	单位 Unit
Peak Repetitive Reverse Voltage	V_{RRM}	100	V
Working Peak Reverse Voltage	V_{RWM}	100	V
Reverse forward current	I_{FRM}	20	A
Average Forward Current	$I_{F(AV)}$	10	A
Average Forward Current (total)	$I_{F(AV)}$ (total)	20	A
Non Repetitive Peak Surge Current	I_{FSM}	150	A
Peak Repetitive Reverse Current	I_{RRM}	0.5	A
Thermal Resistance Junction to Case	$R_{\theta Jc}$	3.5	°C/W
Junction Temperature Range	T_j	150	°C
Storage Temperature Range	T_{stg}	-55~150	°C

电性能参数 / Electrical Characteristics(Ta=25°C)

参数 Parameter	符号 Symbol	测试条件 Test Conditions	最小值 Min	典型值 Typ	最大值 Max	单位 Unit
Forward Voltage	V_F	$I_F = 10A(T_c = 25^\circ C)$			0.8	V
		$I_F = 10A(T_c = 125^\circ C)$			0.7	V
		$I_F = 20A(T_c = 25^\circ C)$			0.95	V
		$I_F = 20A(T_c = 125^\circ C)$			0.85	V
Instantaneous Reverse Current	I_R	$V_R = 100V(T_c = 25^\circ C)$			0.15	mA
		$V_R = 100V(T_c = 125^\circ C)$			150	mA
Critical rate of rise of reverse voltage	dv/dt				10000	V/ μ s

电参数曲线图 / Electrical Characteristic Curve

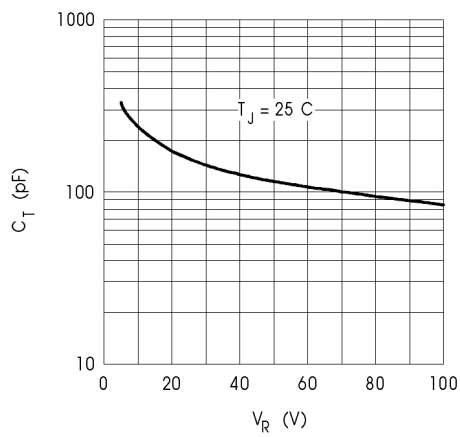
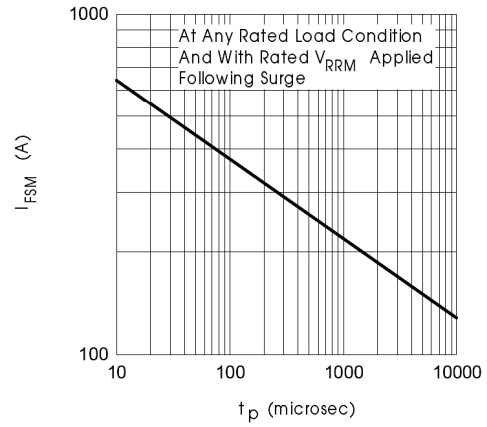
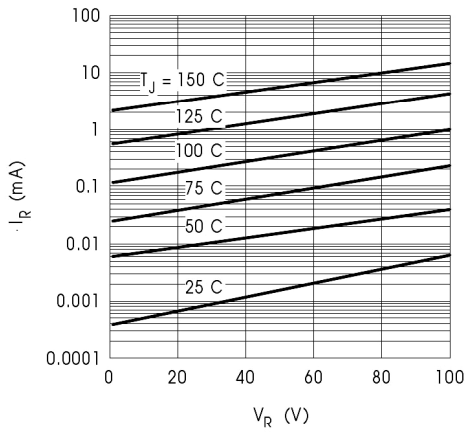
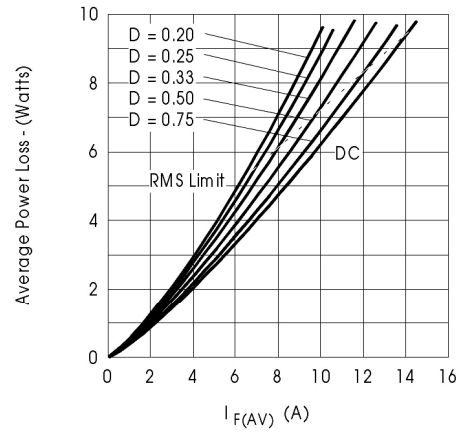
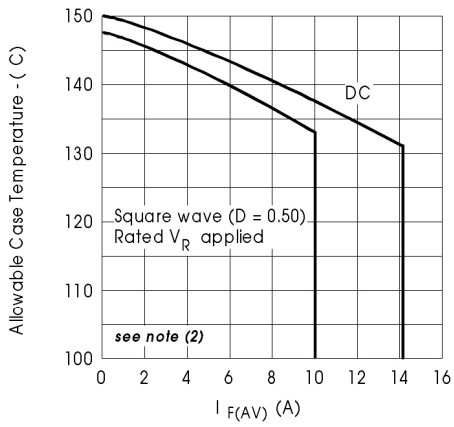

外形尺寸图 / Package Dimensions

TO-220F

单位: mm

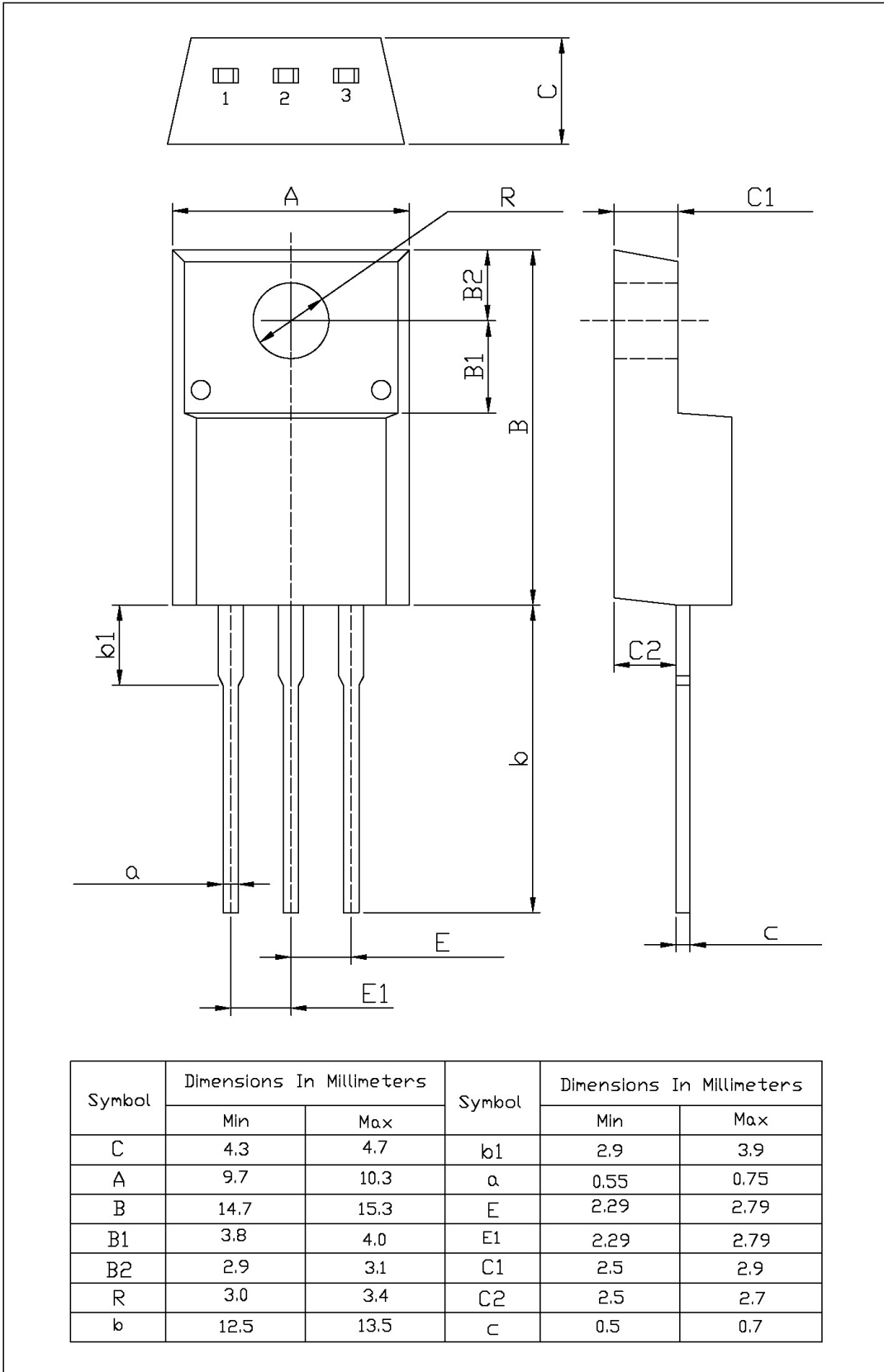

印章说明 / Marking Instructions

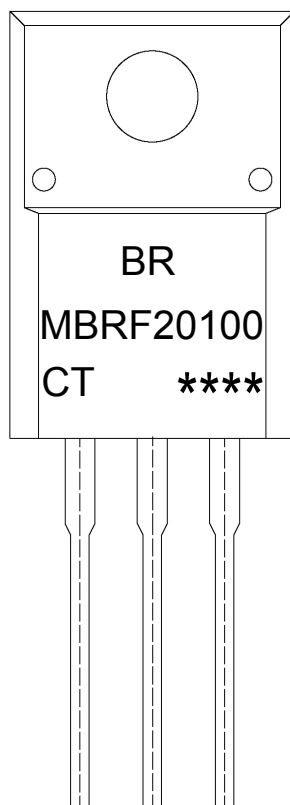

说明：

BR： 为公司代码

MBRF20100： 为产品型号

CT： 为内部结构

****： 为生产批号代码，随生产批号变化。

Note:

BR: Company Code

MBRF20100: Product Type.

CT: Internal Structure

****: Lot No. Code, code change with Lot No.

波峰焊温度曲线图(无铅) / Temperature Profile for Dip Soldering(Pb-Free)



说明：

- 1、预热温度 25 ~ 150°C，时间 60 ~ 90sec；
- 2、峰值温度 255±5°C，时间持续为 5±0.5sec；
- 3、焊接制程冷却速度为 2 ~ 10°C/sec.

Note:

- 1.Preheating:25~150°C, Time:60~90sec.
- 2.Peak Temp.:255±5°C, Duration:5±0.5sec.
3. Cooling Speed: 2~10°C/sec.

耐焊接热试验条件 / Resistance to Soldering Heat Test Conditions

温度：270±5°C

时间：10±1 sec.

Temp.:270±5°C

Time:10±1 sec

包装规格 / Packaging SPEC.

散件包装 / BULK

Package Type 封装形式	Units 包装数量					Dimension 包装尺寸 (unit: mm ³)		
	Units/Bag 只/袋	Bags/Inner Box 袋/盒	Units/Inner Box 只/盒	Inner Boxes/Outer Box 盒/箱	Units/Outer Box 只/箱	Bag 袋	Inner Box 盒	Outer Box 箱
TO-220/F	200	10	2,000	5	10,000	135×190	237×172×102	560×245×195

套管包装 / TUBE

Package Type 封装形式	Units 包装数量					Dimension 包装尺寸 (unit: mm ³)		
	Units/Tube 只/套管	Tubes/Inner Box 套管/盒	Units/Inner Box 只/盒	Inner Boxes/Outer Box 盒/箱	Units/Outer Box 只/箱	Tube 套管	Inner Box 盒	Outer Box 箱
TO-220/F	50	20	1,000	5	5,000	532×31.4×5.5	555×164×50	575×290×180

使用说明 / Notices