

FEATURES

Integrated dual-channel RF front end
2-stage LNA and high power SPDT switch
On-chip bias and matching
Single supply operation

Gain

High gain mode: 32 dB typical at 3.6 GHz
Low gain mode: 16 dB typical at 3.6 GHz

Low noise figure

High gain mode: 1.45 dB typical at 3.6 GHz
Low gain mode: 1.45 dB typical at 3.6 GHz

High isolation

RXOUT-CHA and RXOUT-CHB: 47 dB typical
TERM-CHA and TERM-CHB: 52 dB typical

Low insertion loss: 0.65 dB typical at 3.6 GHz

High power handling at $T_{CASE} = 105^{\circ}C$

Full lifetime

LTE average power (9 dB PAR): 40 dBm
Single event (<10 sec operation)
LTE average power (9 dB PAR): 43 dBm

High OIP3: 32 dBm typical

Power-down mode and low gain mode for LNA

Low supply current

High gain mode: 86 mA typical at 5 V
Low gain mode: 36 mA typical at 5 V
Power-down mode: 12 mA typical at 5 V

Positive logic control

6 mm × 6 mm, 40-lead LFCSP package

APPLICATIONS

Wireless infrastructure

TDD massive multiple input and multiple output and active antenna systems

TDD-based communication systems

GENERAL DESCRIPTION

The ADRF5545A is a dual-channel, integrated radio frequency (RF), front-end multichip module designed for time division duplexing (TDD) applications that operates from 2.4 GHz to 4.2 GHz. The ADRF5545A is configured in dual channels with a cascading two-stage low noise amplifier (LNA) and a high power silicon single-pole, double-throw (SPDT) switch.

In high gain mode, the cascaded two-stage LNA and switch offer a low noise figure (NF) of 1.45 dB and a high gain of 32 dB at 3.6 GHz with an output third-order intercept point (OIP3) of 32 dBm (typical). In low gain mode, one stage of the two-stage LNA is in bypass, providing 16 dB of gain at a lower

FUNCTIONAL BLOCK DIAGRAM

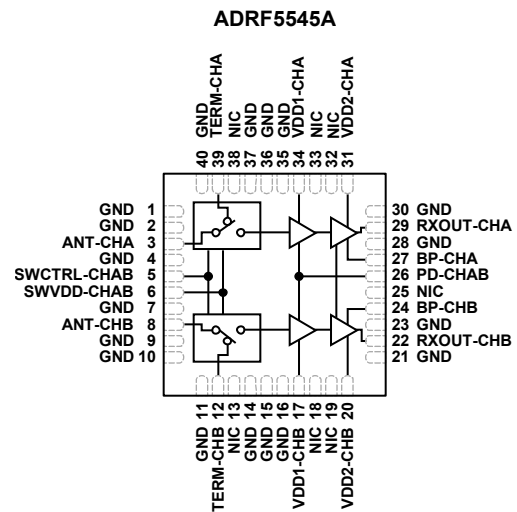

20051-001

current of 36 mA. In power-down mode, the LNAs are turned off and the device draws 12 mA.

In transmit operation, when RF inputs are connected to a termination pin (TERM-CHA or TERM-CHB), the switch provides a low insertion loss of 0.65 dB and handles long-term evolution (LTE) average power (9 dB peak to average ratio (PAR)) of 40 dBm for full lifetime operation and 43 dBm for single event (<10 sec) LNA protection operation.

The device comes in an RoHS compliant, compact, 6 mm × 6 mm, 40-lead LFCSP package.

Rev. B

[Document Feedback](#)

Information furnished by Analog Devices is believed to be accurate and reliable. However, no responsibility is assumed by Analog Devices for its use, nor for any infringements of patents or other rights of third parties that may result from its use. Specifications subject to change without notice. No license is granted by implication or otherwise under any patent or patent rights of Analog Devices. Trademarks and registered trademarks are the property of their respective owners.

TABLE OF CONTENTS

Features	1	Receive Operation, High Gain Mode	8
Applications	1	Receive Operation, Low Gain Mode	10
Functional Block Diagram	1	Transmit Operation	12
General Description	1	Receive Operation, High Gain Mode with 2.6 GHz Tuning	13
Revision History	2	Receive Operation, Low Gain Mode with 2.6 GHz Tuning.	15
Specifications	3	Transmit Operation at with 2.6 GHz Tuning	17
Electrical Specifications.....	3	Theory of Operation	18
2.6 GHz Tuned Operation	4	Signal Path Select.....	18
Absolute Maximum Ratings	5	Biasing Sequence	18
Thermal Resistance	5	Applications Information	19
ESD Caution.....	5	2.6 GHz Operation.....	19
Pin Configuration and Function Descriptions	6	Outline Dimensions.....	20
Interface Schematics	7	Ordering Guide	20
Typical Performance Characteristics.....	8		

REVISION HISTORY

4/2020—Rev. A to Rev. B

Changes to Theory of Operation Section.....	18
Changes to Applications Information Section and Figure 47.....	19

5/2019—Revision A: Initial Version

SPECIFICATIONS

ELECTRICAL SPECIFICATIONS

VDD1-CHA, VDD1-CHB, VDD2-CHA, VDD2-CHB, and SWVDD-CHAB = 5 V; SWCTRL-CHAB = 0 V or SWVDD-CHAB; BP-CHA = VDD1-CHA or 0 V; BP-CHB = VDD1-CHB or 0 V; PD-CHAB = 0 V or VDD1-CHA; case temperature (T_{CASE}) = 25°C, 50 Ω system, unless otherwise noted.

Table 1.

Parameter	Test Conditions/Comments	Min	Typ	Max	Unit
FREQUENCY RANGE		2.4		4.2	GHz
GAIN ¹	Receive operation at 3.6 GHz				
High Gain Mode			32		dB
Low Gain Mode			16		dB
GAIN FLATNESS ¹	Receive operation in any 100 MHz bandwidth				
High Gain Mode			0.6		dB
Low Gain Mode			0.2		dB
NOISE FIGURE (NF) ¹	Receive operation at 3.6 GHz				
High Gain Mode			1.45		dB
Low Gain Mode			1.45		dB
OUTPUT THIRD-ORDER INTERCEPT POINT (OIP3) ¹	Receive operation, two-tone output power = 8 dBm per tone at 1 MHz tone spacing				
High Gain Mode			32		dBm
Low Gain Mode			29		dBm
OUTPUT 1 dB COMPRESSION (OP1dB)					
High Gain Mode			19		dBm
Low Gain Mode			12		dBm
INSERTION LOSS ¹	Transmit operation at 3.6 GHz		0.65		dB
Channel to Channel Isolation ¹	At 3.6 GHz				
Between RXOUT-CHA AND RXOUT-CHB	Receive operation		47		dB
Between TERM-CHA AND TERM-CHB	Transmit operation		52		dB
SWITCH ISOLATION					
ANT-CHA TO TERM-CHA AND ANT-CHB TO TERM-CHB ¹	Transmit operation, PD-CHAB = 0 V		25		dB
SWITCHING CHARACTERISTICS (t_{ON} , t_{OFF})					
	50% control voltage to 90%, 10% of RXOUT-CHA or RXOUT-CHB in receive operation		860		ns
	50% control voltage to 90%, 10% of TERM-CHA or TERM-CHB in transmit operation		800		ns
RF INPUT POWER AT ANT-CHA, ANT-CHB ¹	Receive operation, LTE average (9 dB PAR)			15	dBm
INPUT 0.1dB COMPRESSION (P0.1dB)	100 μs pulse width, 10% duty cycle, $T_{CASE} = 25^{\circ}C^2$		50		dBm
RECOMMENDED OPERATING CONDITIONS					
Bias Voltage Range	VDD1-CHA, VDD1-CHB, VDD2-CHA, VDD2-CHB, SWVDD-CHAB	4.75	5	5.25	V
Control Voltage Range	SWCTRL-CHAB, BP-CHA, BP-CHB, PD-CHAB	0		V_{DD}^3	V
RF Input Power at ANT-CHA, ANT-CHB	SWCTRL-CHAB = 5 V, PD-CHAB = 5 V, BP-CHA = BP-CHB = 0 V, $T_{CASE} = 105^{\circ}C^2$				
	Continuous wave			40	dBm
	9 dB PAR LTE full lifetime average			40	dBm
	9 dB PAR LTE single event (<10 sec) average			43	dBm
Case Temperature Range (T_{CASE}) ²		-40		+105	°C
Junction Temperature at Maximum T_{CASE}^2					
	Receive operation ¹			132	°C
	Transmit operation ¹			134	°C

Parameter	Test Conditions/Comments	Min	Typ	Max	Unit
DIGITAL INPUT					
SWCTRL-CHAB, PD-CHAB					
Low (V_{IL})		0		0.7	V
High (V_{IH})		1.4		V_{DD}^3	V
BP-CHA, BP-CHB					
Low (V_{IL})		0		0.3	V
High (V_{IH})		1.0		V_{DD}^3	V
SUPPLY CURRENT (I_{DD})	VDD1-CHx and VDD2-CHx = 5 V per channel				
High Gain			86		mA
Low Gain			36		mA
Power-Down Mode			12		mA
TX Current (Switch)	SWVDD-CHAB = 5 V		4.3		mA
DIGITAL INPUT CURRENTS	SWCTRL-CHAB, PD-CHAB, BP-CHA, BP-CHB = 5 V per channel				
SWCTRL-CHAB			0.0004		mA
PD-CHAB			0.19		mA
BP-CHA, BP-CHB			0.19		mA

¹ See Table 6 and Table 7.

² Measured at EPAD.

³ V_{DD} is the voltage of the SWVDD-CHAB, VDD1-CHA, VDD1-CHB, VDD2-CHA, and VDD2-CHB pins.

2.6 GHZ TUNED OPERATION

The ADRF5545A-EVALZ can be optimized for 2.6 GHz operation, with external matching (see the [ADRF5545A-EVALZ](#) user guide for more information). The typical 2.6 GHz specifications with external matching are shown in Table 2.

Table 2. Typical Specifications at 2.6 GHz

Parameter	Test Conditions/Comments	Min	Typ	Max	Unit
GAIN ¹	Receive operation at 2.6 GHz				
High Gain Mode			34		dB
Low Gain Mode			17		dB
GAIN FLATNESS ¹	Receive operation in any 100 MHz bandwidth				
High Gain Mode			0.6		dB
Low Gain Mode			0.2		dB
NOISE FIGURE (NF) ¹	Receive operation at 2.6 GHz				
High Gain Mode			1.5		dB
Low Gain Mode			1.5		dB
OUTPUT THIRD ORDER INTERCEPT POINT (OIP3) ¹	Receive operation at 1 MHz tone spacing				
High Gain Mode			31		dBm
Low Gain Mode			31		dBm
OUTPUT 1 dB COMPRESSION (OP1dB)					
High Gain Mode			18		dBm
Low Gain Mode			13		dBm
INSERTION LOSS ¹	Transmit operation at 2.6 GHz		0.60		dB
CHANNEL TO CHANNEL ISOLATION	At 2.6 GHz				
Between RXOUT-CHA and RXOUT-CHB ¹	Receive operation		40		dB
Between TERM-CHA and TERM-CHB ¹	Transmit operation		57		dB
SWITCH ISOLATION					
ANT-CHA to TERM-CHA and ANT-CHB to TERM-CHB ¹	Transmit operation		25		dB

¹ See Table 6 and Table 7.

ABSOLUTE MAXIMUM RATINGS

Table 3.

Parameter	Rating
Positive Supply Voltage VDD1-CHA, VDD1-CHB, VDD2-CHA, VDD2-CHB	7 V
SWVDD-CHAB	5.4 V
Digital Control Input Voltage SWCTRL-CHAB	-0.3 V to $V_{DD}^1 + 0.3$ V
BP-CHA, BP-CHB, PD-CHAB	-0.3 V to $V_{DD}^1 + 0.3$ V
RF Input Power	
Transmit Input Power (LTE Peak)	53 dBm
Receive Input Power (LTE Peak)	25 dBm
Temperature	
Storage	-65°C to +150°C
Reflow	260°C
Electrostatic Discharge (ESD) Sensitivity	
Human Body Model (HBM)	500 V, Class 1B
Charge Device Model (CDM)	1.25 kV

¹ V_{DD} is the voltage of the SWVDD-CHAB, VDD1-CHA, VDD1-CHB, VDD2-CHA, and VDD2-CHB pins.

Stresses at or above those listed under Absolute Maximum Ratings may cause permanent damage to the product. This is a stress rating only; functional operation of the product at these or any other conditions above those indicated in the operational section of this specification is not implied. Operation beyond the maximum operating conditions for extended periods may affect product reliability.

THERMAL RESISTANCE

Thermal performance is directly linked to printed circuit board (PCB) design and operation environment. Careful attention to PCB thermal design is required.

θ_{JC} is the junction to case bottom (channel to package bottom) thermal resistance.

Table 4. Thermal Resistance

Package Type	θ_{JC}	Unit
CP-40-15		
High Gain and Low Gain Mode	30	°C/W
Power-Down Mode	8.7	°C/W

ESD CAUTION



ESD (electrostatic discharge) sensitive device. Charged devices and circuit boards can discharge without detection. Although this product features patented or proprietary protection circuitry, damage may occur on devices subjected to high energy ESD. Therefore, proper ESD precautions should be taken to avoid performance degradation or loss of functionality.

PIN CONFIGURATION AND FUNCTION DESCRIPTIONS

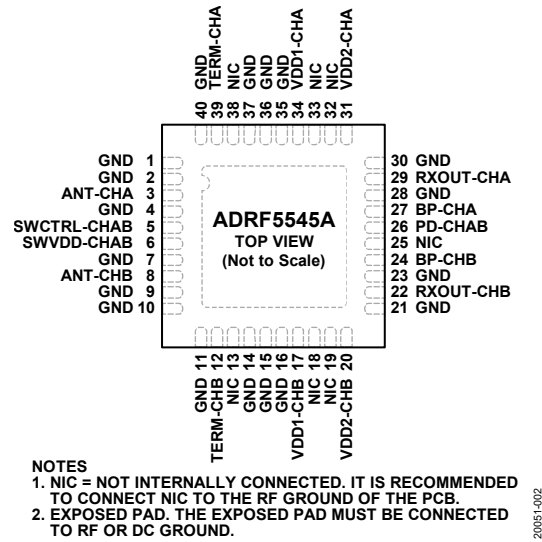

Figure 2. Pin Configuration

Table 5. Pin Function Descriptions

Pin No.	Mnemonic	Description
1, 2, 4, 7, 9 to 11, 14 to 16, 21, 23, 28, 30, 35 to 37, 40	GND	Ground.
3	ANT-CHA	RF Input to Channel A.
5	SWCTRL-CHAB	Control Voltage for Switches on Channel A and Channel B.
6	SWVDD-CHAB	Supply Voltage for Switches on Channel A and Channel B.
8	ANT-CHB	RF Input to Channel B.
12	TERM-CHB	Termination Output for Channel B. This pin is the transmitter path for Channel B.
13, 18, 19, 25, 32, 33, 38	NIC	Not Internally Connected. It is recommended to connect NIC to the RF ground of the PCB.
17	VDD1-CHB	Supply Voltage for Stage 1 LNA on Channel B.
20	VDD2-CHB	Supply Voltage for Stage 2 LNA on Channel B.
22	RXOUT-CHB	RF Output. This pin is the receiver path for Channel B.
24	BP-CHB	Bypass Second Stage LNA of Channel B.
26	PD-CHAB	Power-Down All Stages of LNA for Channel A and Channel B.
27	BP-CHA	Bypass Second Stage LNA of Channel A.
29	RXOUT-CHA	RF Output. This pin is the receiver path for Channel A.
31	VDD2-CHA	Supply Voltage for Stage 2 LNA on Channel A.
34	VDD1-CHA	Supply Voltage for Stage 1 LNA on Channel A.
39	TERM-CHA	Termination Output for Channel A. This pin is the transmitter path for Channel A.
	EPAD	Exposed Pad. The exposed pad must be connected to RF or dc ground.

INTERFACE SCHEMATICS



Figure 3. GND Interface

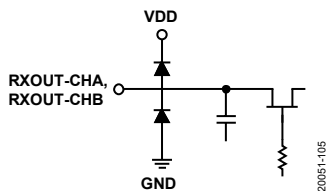

Figure 4. RXOUT-CHx Interface

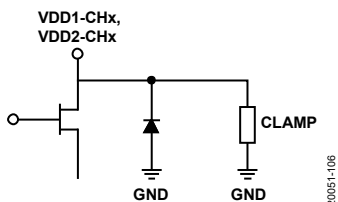

Figure 5. VDD1-CHx, VDD2-CHx Interface

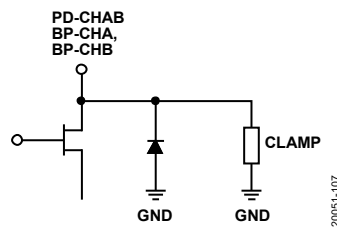

Figure 6. PD-CHAB, BP-CHx Interface

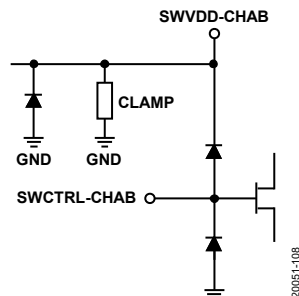

Figure 7. SWCTRL-CHAB, SWVDD-CHAB Interface

TYPICAL PERFORMANCE CHARACTERISTICS

RECEIVE OPERATION, HIGH GAIN MODE

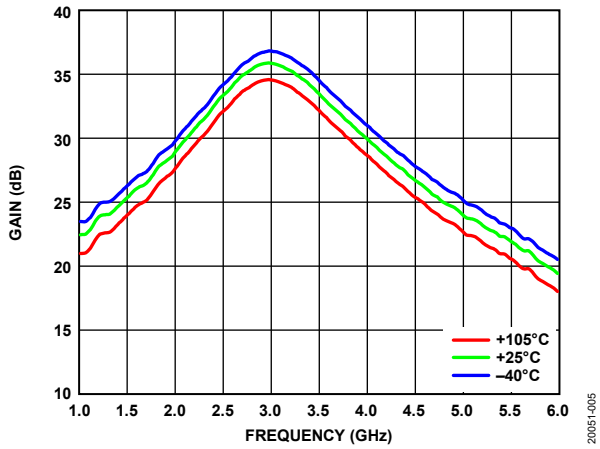

Figure 8. Gain vs. Frequency at Various Temperatures

20051-005

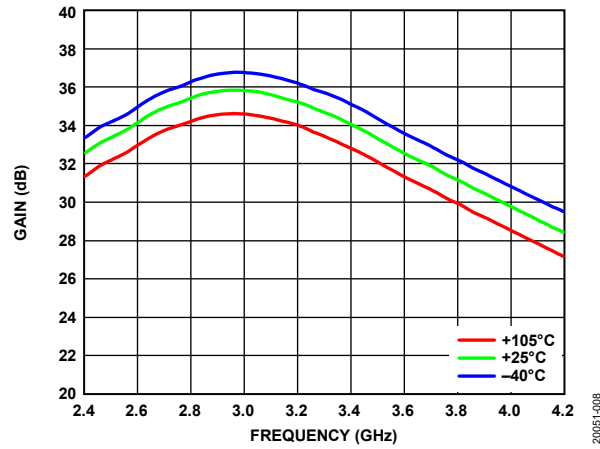

Figure 11. Gain vs. Frequency at Various Temperatures, 2.4 GHz to 4.2 GHz

20051-008

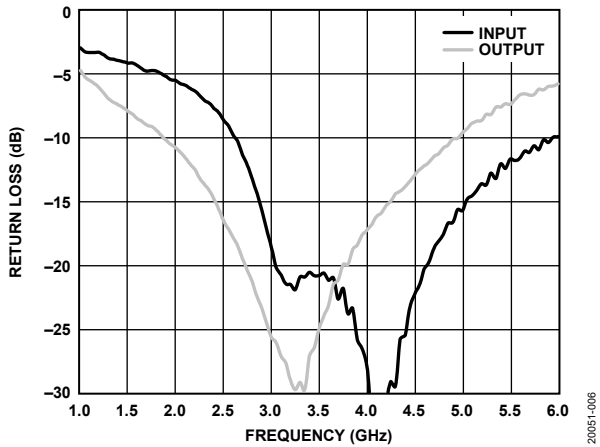

Figure 9. Return Loss vs. Frequency

20051-006

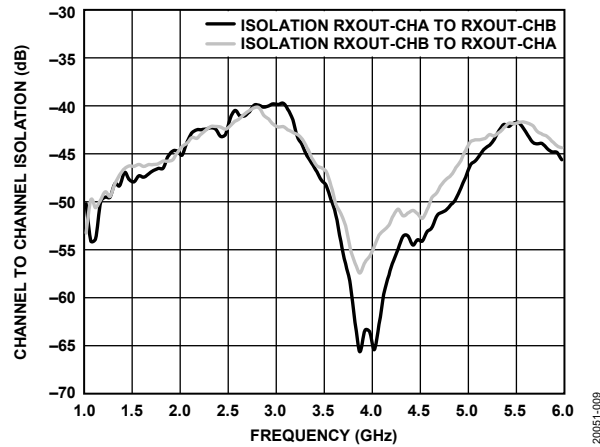

Figure 12. Channel to Channel Isolation vs. Frequency

20051-009

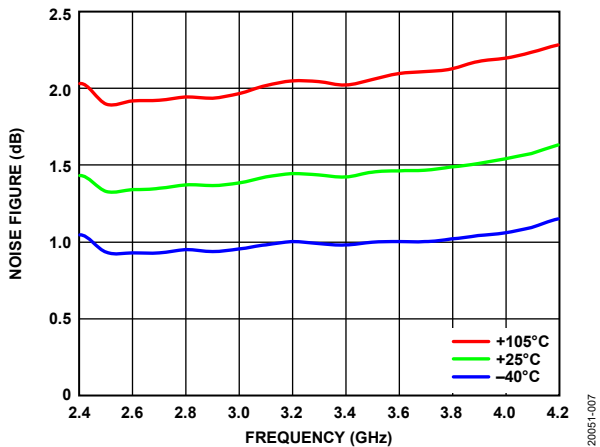

Figure 10. Noise Figure vs. Frequency

20051-007

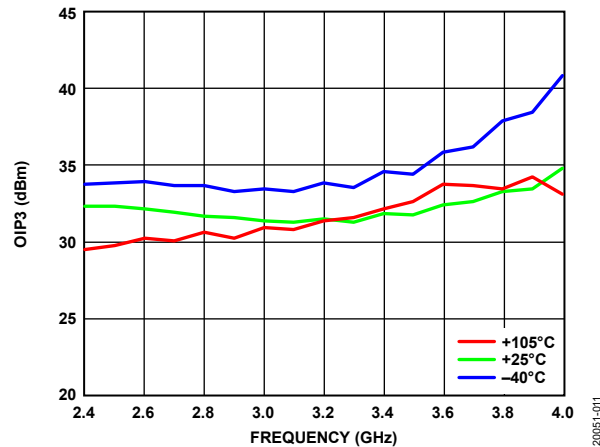

Figure 13. OIP3 vs. Frequency, 8 dBm Output Tone Power

20051-011

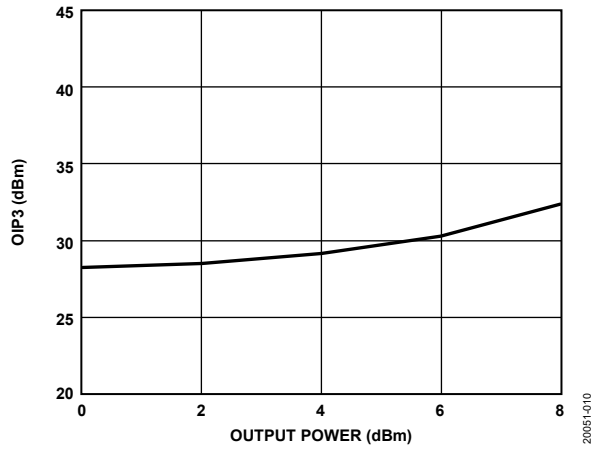

Figure 14. OIP3 vs. Output Power, 3.6 GHz

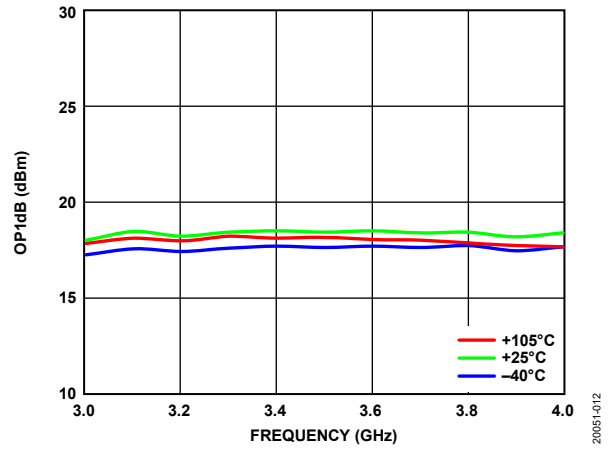

Figure 15. OP1dB vs. Frequency at Various Temperatures

RECEIVE OPERATION, LOW GAIN MODE

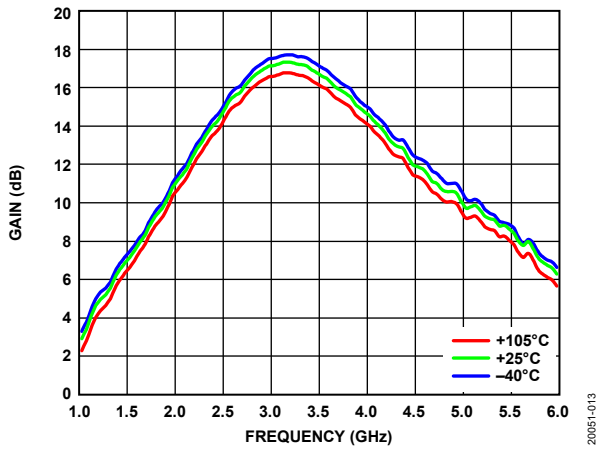

Figure 16. Gain vs. Frequency at Various Temperatures

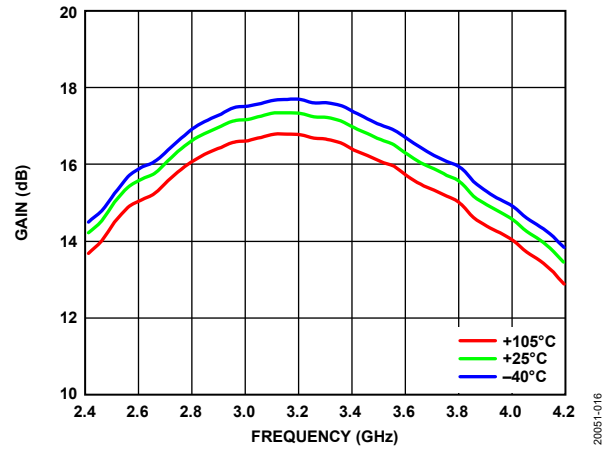

Figure 18. Gain vs. Frequency at Various Temperatures, 2.2 GHz to 4.2 GHz

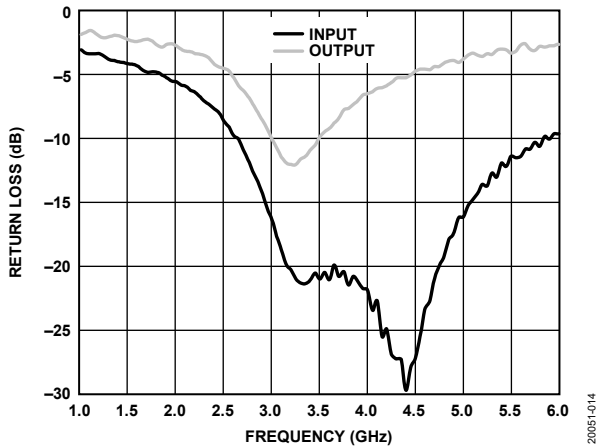

Figure 17. Return Loss vs. Frequency

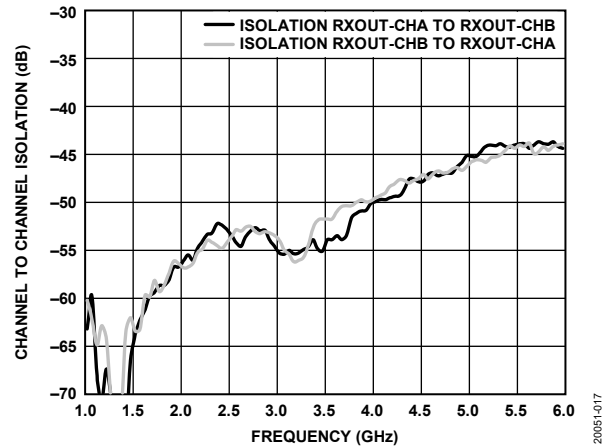

Figure 19. Channel to Channel Isolation vs. Frequency

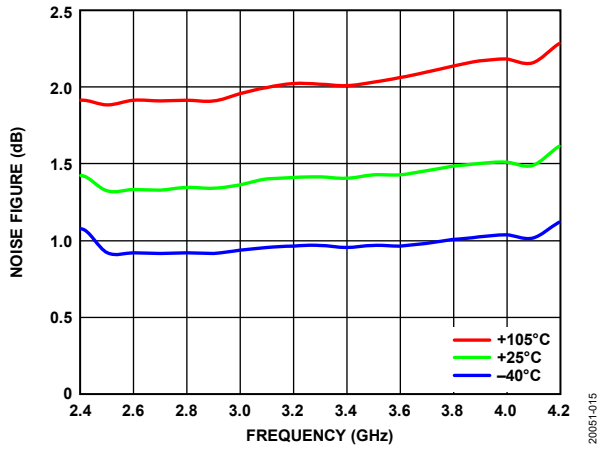

Figure 20. Noise Figure vs. Frequency at Various Temperatures

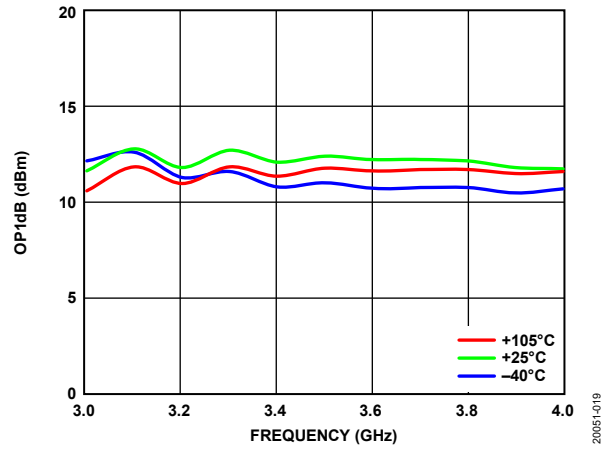

Figure 22. OP1dB vs. Frequency at Various Temperatures

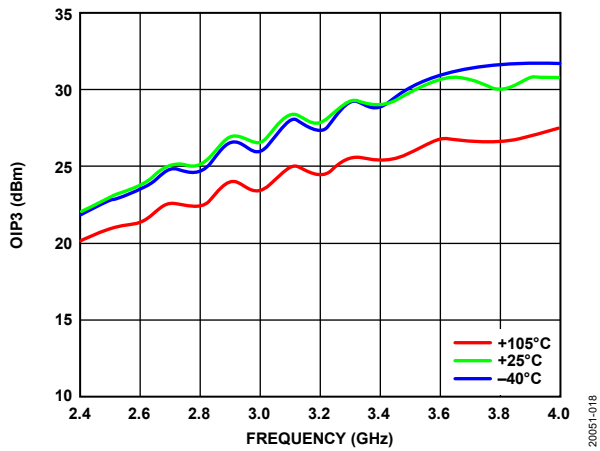

Figure 21. OIP3 vs. Frequency, -10 dBm Output Tone Power

20051-015

20051-019

20051-018

TRANSMIT OPERATION

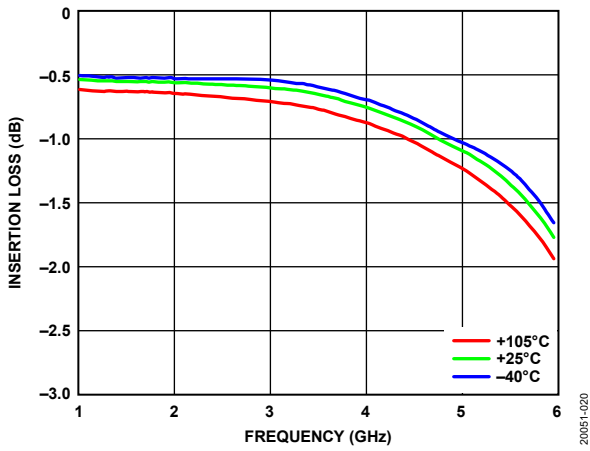

Figure 23. Insertion Loss vs. Frequency at Various Temperatures

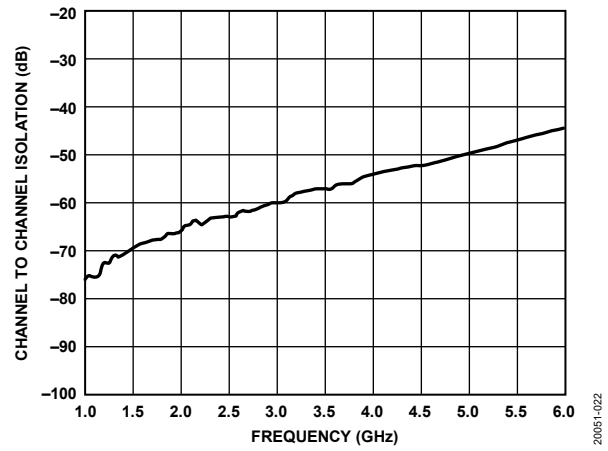

Figure 25. Channel to Channel Isolation vs. Frequency

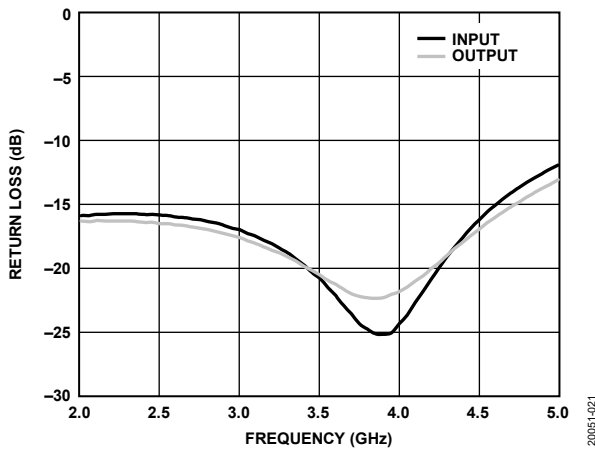

Figure 24. Return Loss vs. Frequency

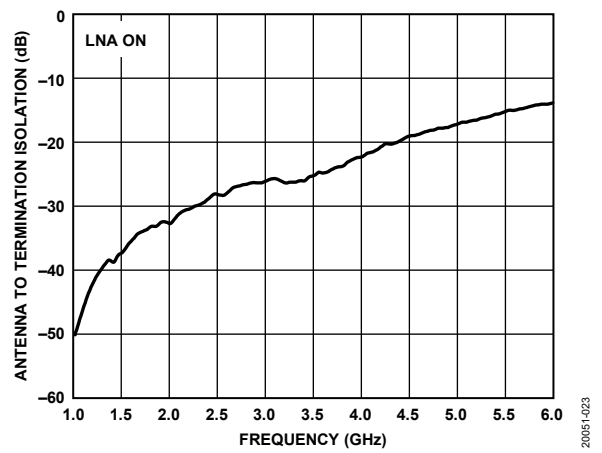

Figure 26. Antenna to Termination Isolation vs. Frequency, LNA On

RECEIVE OPERATION, HIGH GAIN MODE WITH 2.6 GHz TUNING

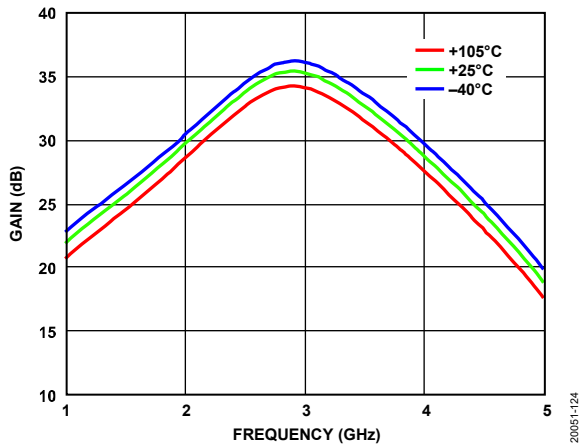

Figure 27. Gain vs. Frequency at Various Temperatures

20051-124

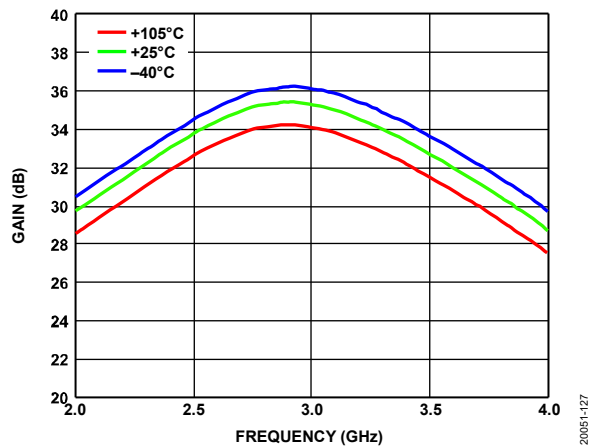

Figure 30. Gain vs. Frequency at Various Temperatures, 2.0 GHz to 4.0 GHz

20051-127

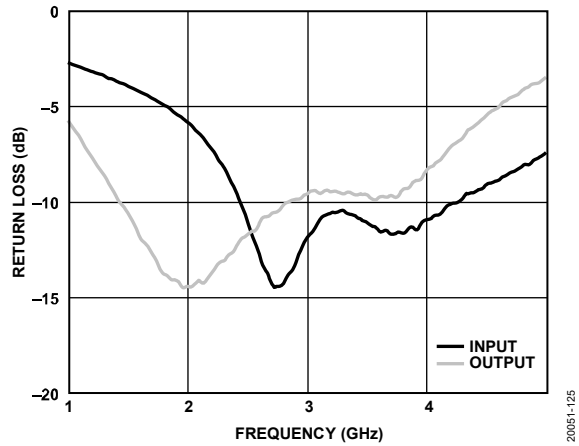

Figure 28. Return Loss vs. Frequency

20051-125

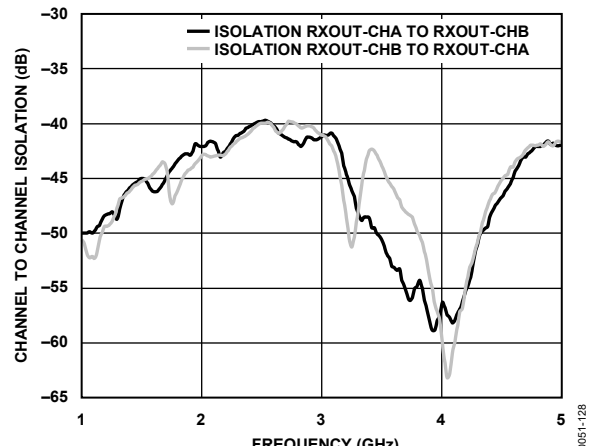

Figure 31. Channel to Channel Isolation vs. Frequency

20051-128

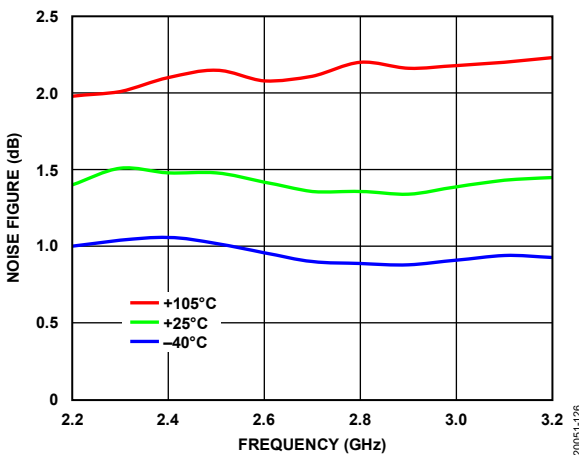

Figure 29. Noise Figure vs. Frequency at Various Temperatures

20051-126

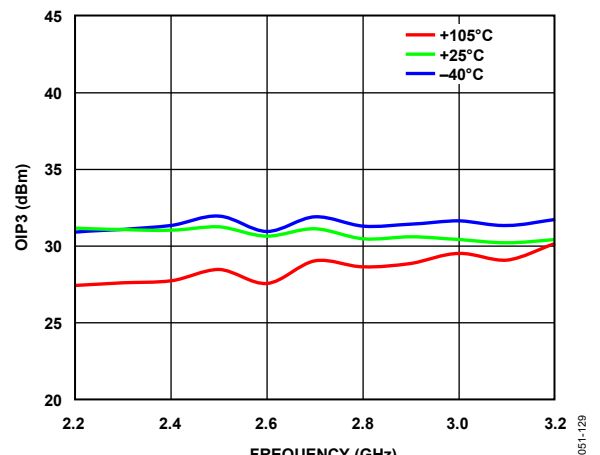

Figure 32. OIP3 vs. Frequency, 8 dBm Output Tone Power

20051-129

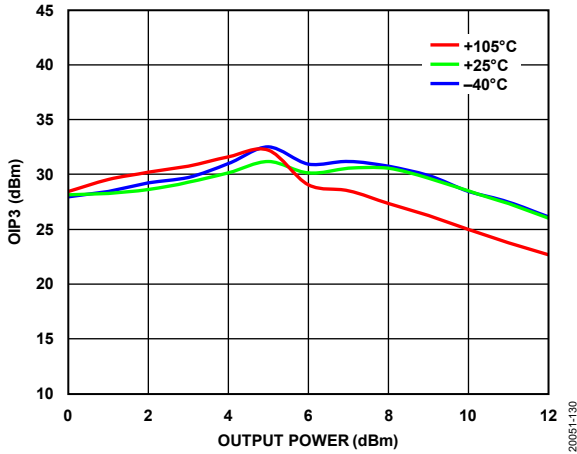

Figure 33. OIP3 vs. Output Power, 2.6 GHz

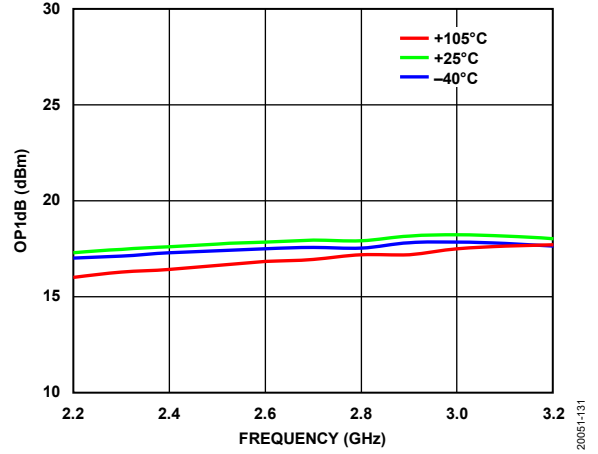

Figure 34. OP1dB vs. Frequency at Various Temperatures

RECEIVE OPERATION, LOW GAIN MODE WITH 2.6 GHz TUNING

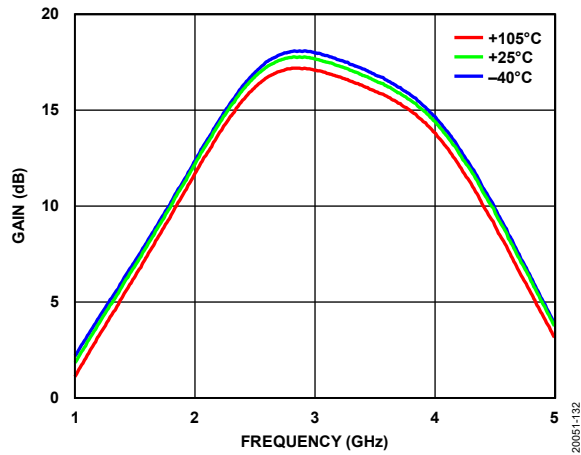

Figure 35. Gain vs. Frequency at Various Temperatures

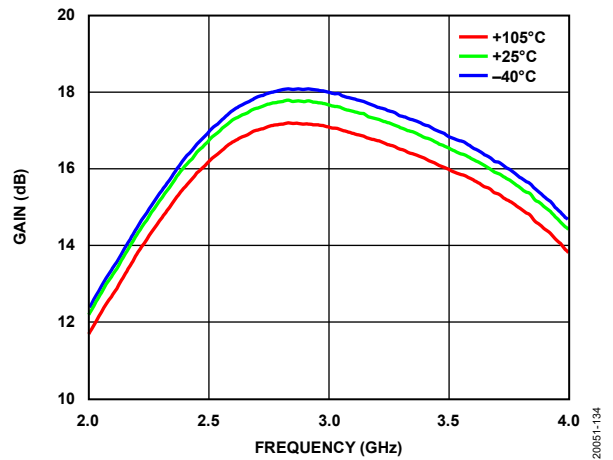

Figure 38. Gain vs. Frequency at Various Temperatures, 2.0 GHz to 4.0 GHz

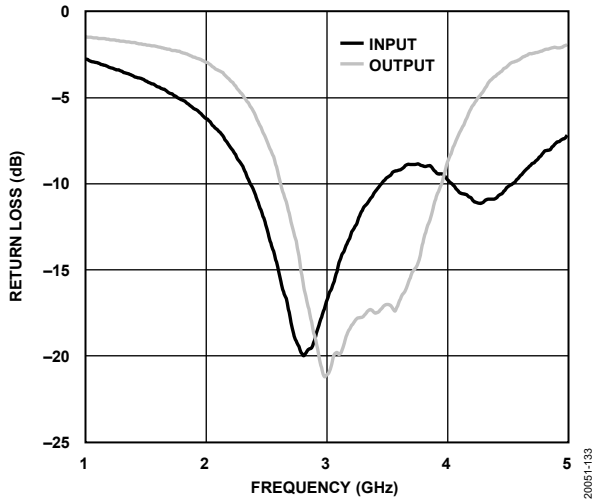

Figure 36. Return Loss vs. Frequency

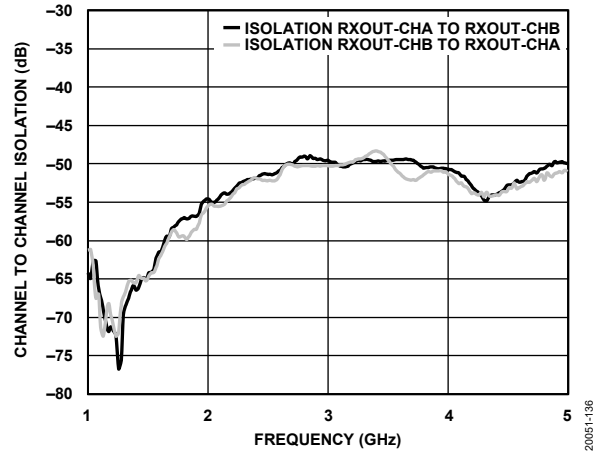

Figure 39. Channel to Channel Isolation vs. Frequency

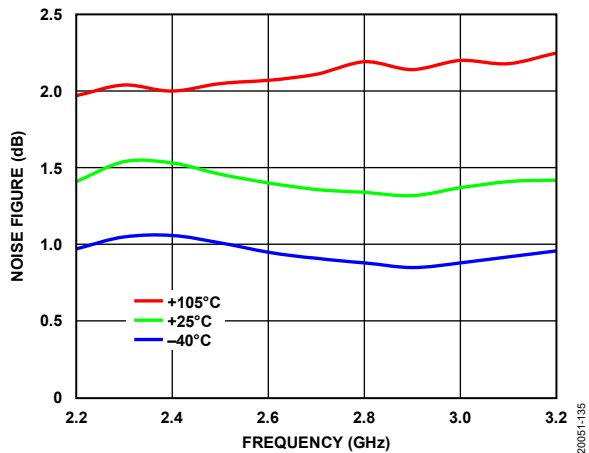

Figure 37. Noise Figure vs. Frequency at Various Temperatures

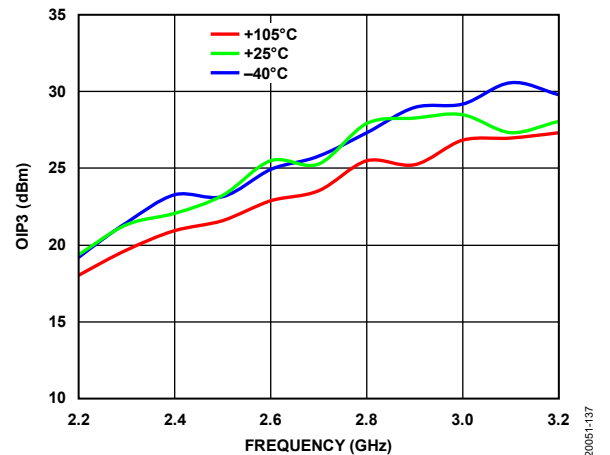

Figure 40. OIP3 vs. Frequency at Various Temperatures, -8 dBm Output Tone Power

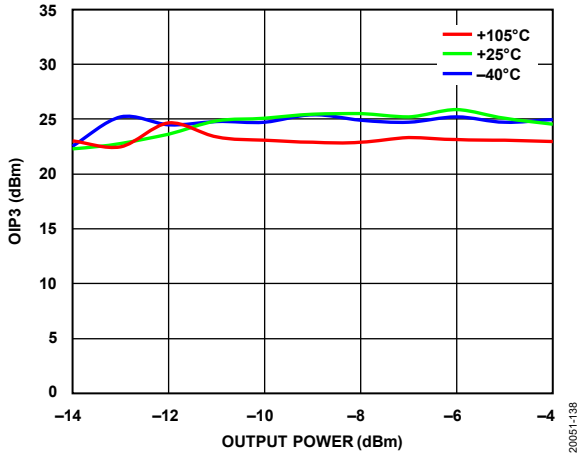

Figure 41. OIP3 vs. Output Power at Various Temperatures, 2.6 GHz

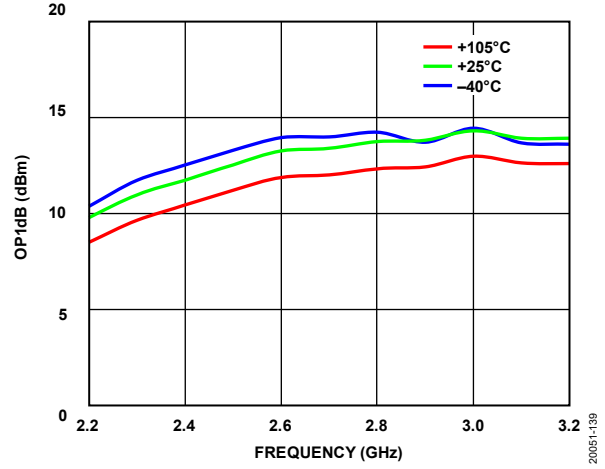

Figure 42. OP1dB vs. Frequency at Various Temperatures

TRANSMIT OPERATION AT WITH 2.6 GHz TUNING

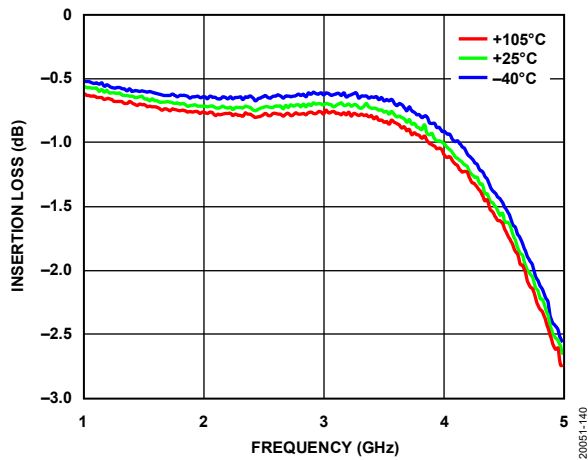

Figure 43. Insertion Loss vs. Frequency at Various Temperatures

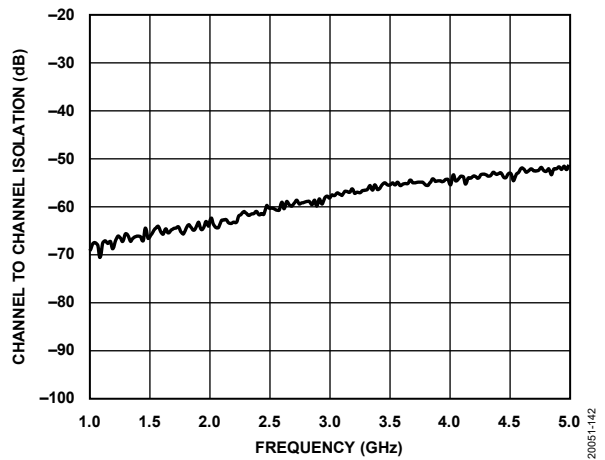

Figure 45. Channel to Channel Isolation vs. Frequency

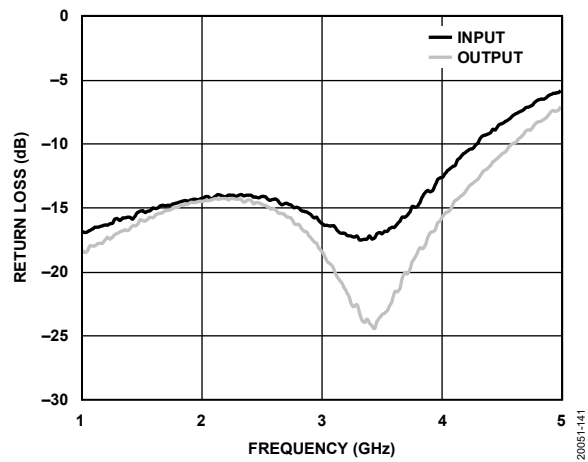

Figure 44. Return Loss vs. Frequency

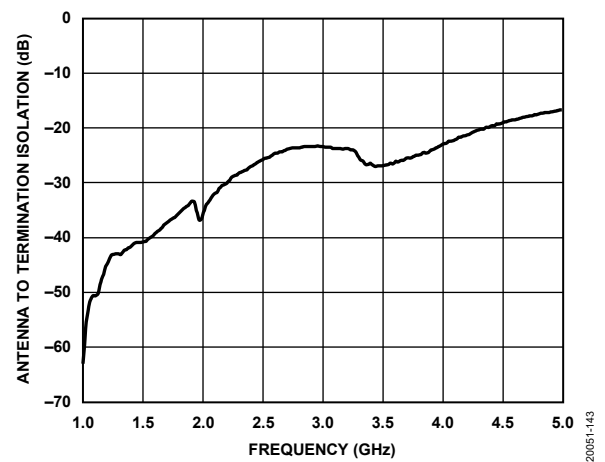

Figure 46. Antenna to Termination Isolation vs. Frequency, LNA On

THEORY OF OPERATION

The ADRF5545A requires a positive supply voltage applied to VDD1-CHA, VDD2-CHA, VDD1-CHB, VDD2-CHB, and SWVDD-CHAB. Use bypassing capacitors on the supply lines to filter noise. Use 300 Ω series resistors on the BP_CHx and PD-CHAB digital control pins for glitch and overcurrent protection.

SIGNAL PATH SELECT

The ADRF5545A supports transmit operations when 5 V is applied to SWCTRL-CHAB. In transmit operation, when an RF input is applied to ANT-CHA and ANT-CHB, the signal paths are connected from ANT-CHA to TERM-CHA and from ANT-CHB to TERM-CHB.

The ADRF5545A supports receive operations when 0 V is applied to SWCTRL-CHAB. In receive operation, an RF input applied at ANT-CHA and ANT-CHB connects ANT-CHA to RXOUT-CHA and ANT-CHB to RXOUT-CHB.

Transmit Operation

The ADRF5545 supports insertion loss mode and isolation mode when in transmit operation, that is, when SWCTRL-CHAB = 5 V. As detailed in Table 7, with PD-CHAB set to 5 V and BP-CHA or BP-CHB set to 0 V, insertion loss mode is selected. Under the same circumstances, isolation mode is selected by applying 0 V to PD-CHAB.

Receive Operation

The ADRF5545A supports high gain mode, low gain mode, power-down high isolation mode, and power-down low isolation mode in receive operation, as detailed in Table 7.

When 0 V is applied to PD-CHAB, the LNA is powered up and the user can select high gain mode or low gain mode. To select high gain mode, apply 0 V to BP-CHA or BP-CHB. To select low gain mode, apply 5 V to BP-CHA or BP-CHB.

When 5 V is applied to PD-CHAB, the ADRF5545A enters power-down mode. To select power-down high isolation mode, apply 0 V to BP-CHA or BP-CHB. To select power-down low isolation mode, apply 5 V to BP-CHA or BP-CHB.

BIASING SEQUENCE

To bias up the ADRF5545A, perform the following steps:

1. Connect GND to ground.
2. Bias up VDD1-CHA, VDD2-CHA, VDD1-CHB, VDD2-CHB, and SWVDD-CHAB.
3. Bias up SWCTRL-CHAB.
4. Bias up PD-CHAB.
5. Bias up BP-CHA and BP-CHB.
6. Apply an RF input signal.

To bias down, perform these steps in the reverse order.

Table 6. Truth Table: Signal Path

SWCTRL-CHAB	Signal Path Select	
	Transmit Operation ¹	Receive Operation
Low	Off	On
High	On	Off

¹ See the signal path descriptions in Table 7.

Table 7. Truth Table: Operation

Operation	PD-CHAB	BP-CHA, BP-CHB	Signal Path
Receive Operation			ANT-CHA to RXOUT-CHA, ANT-CHB to RXOUT-CHB
High Gain Mode	Low	Low	
Low Gain Mode	Low	High	
Power-Down High Isolation Mode	High	Low	
Power-Down Low Isolation Mode	High	High	
Transmit Operation			ANT-CHA to TERM-CHA, ANT-CHB to TERM-CHB
Insertion Loss Mode	High	Low	
Isolation Mode	Low	Low	

APPLICATIONS INFORMATION

To generate the evaluation PCB used in a typical application circuit (see the [ADRF5545A-EVALZ](#) user guide for more information), use proper RF circuit design techniques. Signal lines at the RF port must have a 50 Ω impedance, and the package ground leads and the backside ground slug must connect directly to the ground plane. Use 300 Ω series resistors on the BP-CHx and PD-CHAB digital control pins for glitch and overcurrent protection. The evaluation board shown in Figure 47 is available from Analog Devices, Inc., upon request.

2.6 GHZ OPERATION

The ADRF5545A can be used for applications at 2.6 GHz (see the [ADRF5545A-EVALZ](#) user guide for more information). Table 2 shows the specifications of this evaluation board tuned at 2.6 GHz. See Figure 27 to Figure 46 for the typical performance plots reflecting these specifications at 2.6 GHz.

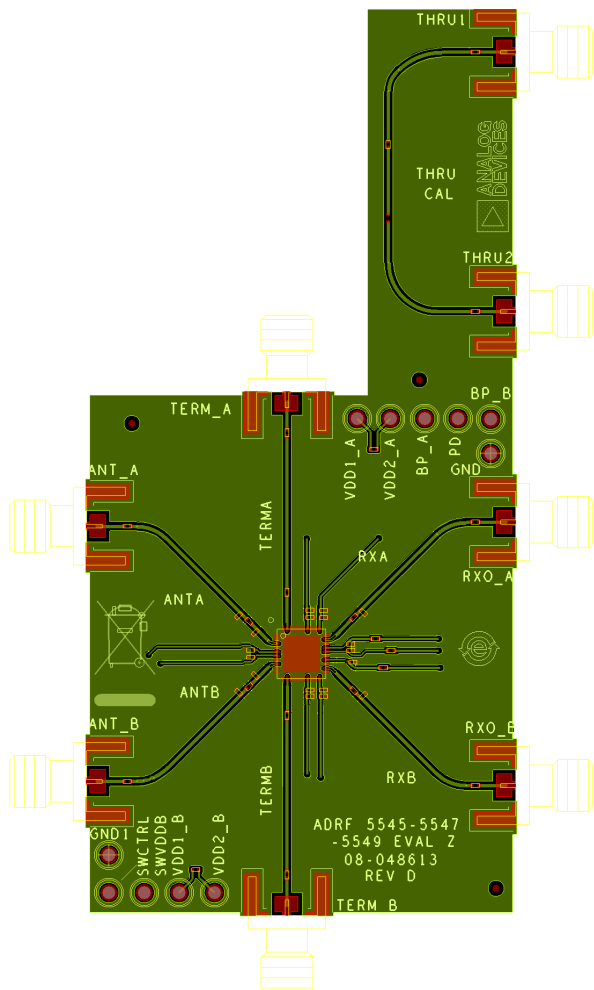
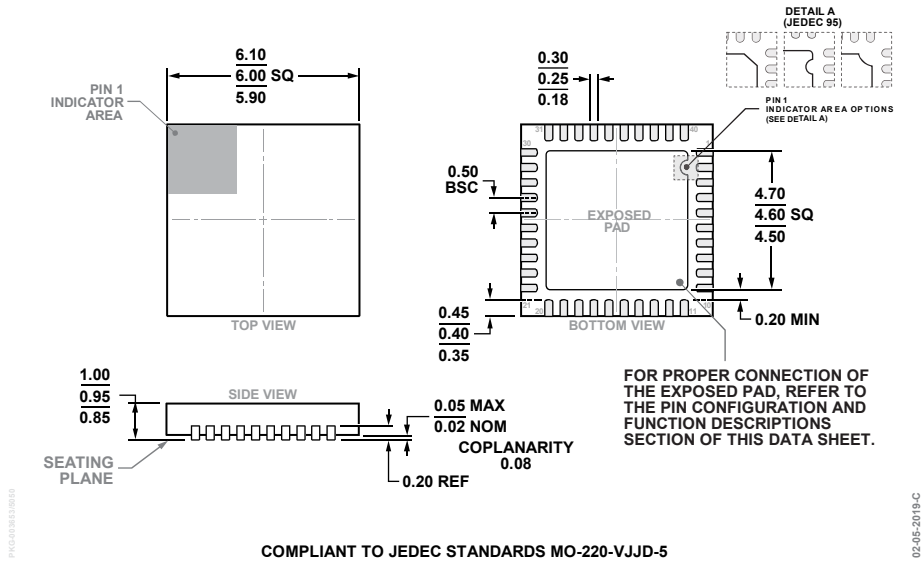

Figure 47. ADRF5545A-EVALZ Evaluation Board

OUTLINE DIMENSIONS



COMPLIANT TO JEDEC STANDARDS MO-220-VJJD-5
 Figure 48. 40-Lead Lead Frame Chip Scale Package [LFCSP]
 6 mm × 6 mm Body and 0.95 mm Package Height
 (CP-40-15)
 Dimensions shown in millimeters

ORDERING GUIDE

Model ¹	Temperature Range	Package Description	Package Option
ADRF5545ABCPZN	−40°C to +105°C	40-Lead Lead Frame Chip Scale Package [LFCSP]	CP-40-15
ADRF5545ABCPZN-R7	−40°C to +105°C	40-Lead Lead Frame Chip Scale Package [LFCSP]	CP-40-15
ADRF5545ABCPZN-RL	−40°C to +105°C	40-Lead Lead Frame Chip Scale Package [LFCSP]	CP-40-15
ADRF5545A-EVALZ		Evaluation Board	

¹ Z = RoHS Compliant Part.