

**SENSITIVE GATE SILICON  
CONTROLLED RECTIFIERS  
REVERSE BLOCKING  
THYRISTORS**

**DESCRIPTION**

PNPN devices designed for high volume, line-powered consumer applications such as relay and lamp drivers, small motor controls, gate drivers for larger thyristors, and sensing and detection circuits. Supplied in an inexpensive plastic TO-92 package which is readily adaptable for use in automatic insertion equipment.

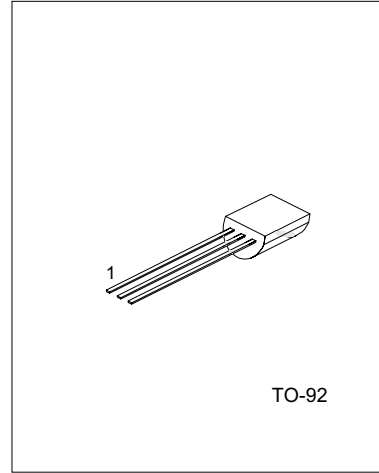

TO-92

1:CATHODE 2:GATE 3:ANODE

**DESCRIPTION**

- \*Sensitive Gate Allows Triggering by Micro controllers and Other Logic circuits
- \*Blocking Voltage to 600V
- \*On-State Current Rating of 0.8A RMS at 80°C
- \*High Surge Current Capability – 10A
- \*Minimum and Maximum Values of IGT, VGT and IH Specified for Ease of Design
- \*Immunity to  $dV/dt$  – 20V/ $\mu$ sec Minimum at 110°C
- \*Glass-Passivated Surface for Reliability and Uniformity

**THERMAL CHARACTERISTICS**

PARAMETER	SYMBOL	MAX	UNIT
Thermal Resistance, Junction to Case	$R_{\theta JC}$	75	°C/W
Thermal Resistance, Junction to Ambient	$R_{\theta JA}$	200	°C/W
Lead Solder Temperature ( $<1/16$ " from case, 10 secs max)	$T_L$	260	°C

**ABSOLUTE MAXIMUM RATINGS**

PARAMETER	SYMBOL	MAX	UNIT
Peak Repetitive Off-State Voltage(note) ( $T_J = -40$ to $110^\circ\text{C}$ , Sine Wave, 50 to 60Hz; Gate Open)	$V_{DRM}, V_{RRM}$		V
MCR100-4		200	
MCR100-6		400	
MCR100-8		600	
On-State RMS Current ( $T_c = 80^\circ\text{C}$ ) 180° Condition Angles	$I_T(\text{RMS})$	0.8	A
Peak Non-Repetitive Surge Current (1/2 cycle, Sine Wave, 60Hz, $T_J = 25^\circ\text{C}$ )	$I_{TSM}$	10	A

PARAMETER	SYMBOL	MAX	UNIT
Circuit Fusing Considerations ( $t=8.3$ ms)	$I^2t$	0.415	A <sup>2</sup> s
Forward Peak Gate Power ( $T_A=25^\circ\text{C}$ , Pulse Width $\leq 1.0\mu\text{s}$ )	PGM	0.1	W
Forward Average Gate Power ( $T_A=25^\circ\text{C}$ , $t=8.3\text{ms}$ )	PG(AV)	0.1	W
Peak Gate Current – Forward ( $T_A=25^\circ\text{C}$ , Pulse Width $\leq 1.0\mu\text{s}$ )	IGM	1	A
Peak Gate Voltage – Reverse ( $T_A=25^\circ\text{C}$ , Pulse Width $\leq 1.0\mu\text{s}$ )	VGRM	5	V
Operating Junction Temperature Range @ Rated $V_{RRM}$ and $V_{DRM}$	$T_J$	-40 to +110	$^\circ\text{C}$
Storage Temperature Range	$T_{stg}$	-40 to +150	$^\circ\text{C}$

Note:  $V_{DRM}$  and  $V_{RRM}$  for all types can be applied on a continuous basis. Ratings apply for zero or negative gate voltage; however, positive gate voltage shall not be applied concurrent with negative potential on the anode. Blocking voltages shall not be tested with a constant current source such that the voltage ratings of the devices are exceeded.

#### ELECTRICAL CHARACTERISTICS ( $T_J=25^\circ\text{C}$ , unless otherwise stated)

PARAMETER	TEST CONDITION	SYMBOL	MIN	TYP	MAX	UNIT
<b>OFF CHARACTERISTICS</b>						
Peak Forward or Reverse Blocking Current $T_C=25^\circ\text{C}$ $T_C=125^\circ\text{C}$	$V_D=\text{Rated } V_{DRM} \text{ and } V_{RRM}; R_{GK}=1\text{k}\Omega$	$I_{DRM}, I_{RRM}$			10 100	$\mu\text{A}$ $\mu\text{A}$
<b>ON CHARACTERISTICS</b>						
Peak Forward On-State Voltage (Note1)	$I_{TM}=1\text{A Peak @ } T_A=25^\circ\text{C}$	$V_{TM}$			1.7	V
Gate Trigger Current (Continuous dc)(note2)	$V_{AK}=7\text{Vdc}, R_L=100\Omega, T_C=25^\circ\text{C}$	$I_{GT}$		40	200	$\mu\text{A}$
Holding Current (note 3) $T_C=25^\circ\text{C}$ $T_C=-40^\circ\text{C}$	$V_{AK}=7\text{Vdc}$ , initiating current=20mA	$I_H$		0.5	5 10	mA
Latch Current $T_C=25^\circ\text{C}$ $T_C=-40^\circ\text{C}$	$V_{AK}=7\text{V}, I_G=200\mu\text{A}$	$I_L$		0.6	10 15	mA
Gate Trigger Current (continuous dc) (Note 2) $T_C=25^\circ\text{C}$ $T_C=-40^\circ\text{C}$	$V_{AK}=7\text{Vdc}, R_L=100\Omega$	$V_{GT}$		0.62	0.8 1.2	V
<b>DYNAMIC CHARACTERISTICS</b>						
Critical Rate of Rise of Off-State Voltage	$V_D=\text{Rated } V_{DRM}$ , Exponential Waveform, $R_{GK}=1000\Omega, T_J=110^\circ\text{C}$	$dV/dt$	20	35		V/ $\mu\text{s}$
Critical Rate of Rise of On-State Current	$I_{PK}=20\text{A}; P_w=10\mu\text{sec}; diG/dt=1\text{A}/\mu\text{sec}, I_{gt}=20\text{mA}$	$di/dt$			50	A/ $\mu\text{s}$

Notes: 1. Indicates Pulse Test Width  $\leq 1.0\text{ms}$ , duty cycle  $\leq 1\%$   
 2.  $R_{GK}=1000\Omega$  included in measurement.  
 3. Does not include  $R_{GK}$  in measurement.

VOLTAGE CURRENT CHARACTERISTIC OF SCR

SYMBOL	PARAMETER
$V_{DRM}$	Peak Repetitive Off Stat Forward Voltage
$I_{DRM}$	Peak Forward Blocking Current
$V_{RRM}$	Peak Repetitive Off State Reverse Voltage
$I_{RRM}$	Peak Reverse Blocking Current
$V_{TM}$	Peak On State Voltage
$I_H$	Holding Current

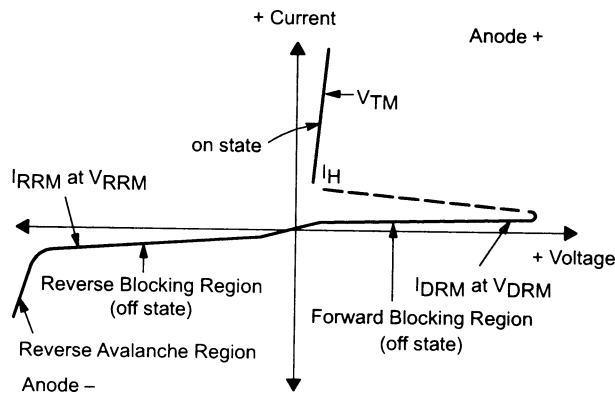

CLASSIFICATION OF  $I_{GT}$

RANK	B	C	AA	AB	AC	AD
RANGE	50-100 $\mu$ A	100-200 $\mu$ A	8-15 $\mu$ A	15-20 $\mu$ A	20-25 $\mu$ A	25-50 $\mu$ A

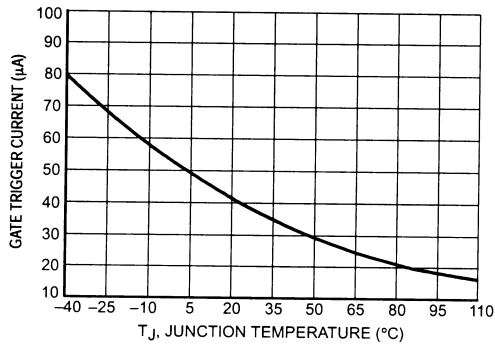

Figure 1. Typical Gate Trigger Current versus Junction Temperature

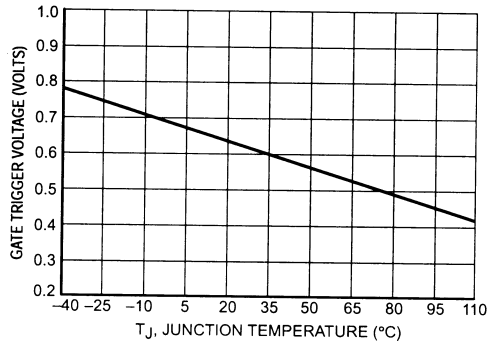

Figure 2. Typical Gate Trigger Voltage versus Junction Temperature

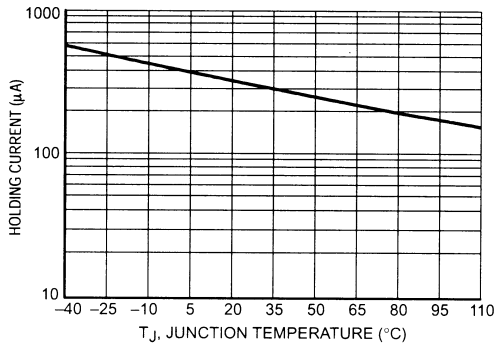

Figure 3. Typical Holding Current versus Junction Temperature

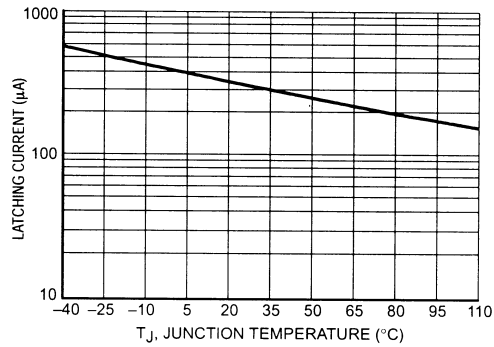

Figure 4. Typical Latching Current versus Junction Temperature

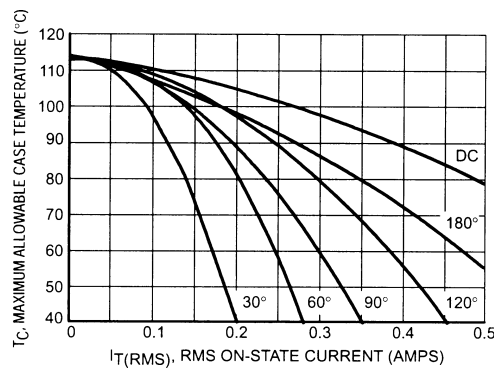

Figure 5. Typical RMS Current Derating

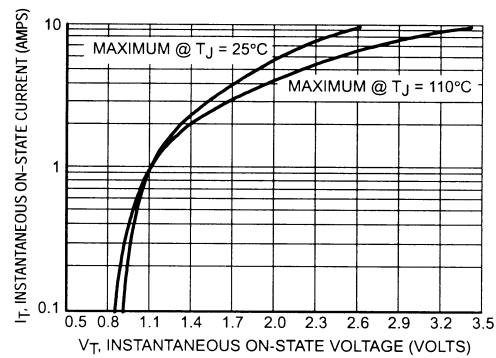

Figure 6. Typical On-State Characteristics