

## Micropower Low-Noise Charge-Pump and Linear Regulator

### Features

- Low noise regulator with integrated charge pump voltage-booster
- 5V output with input voltage as low as 2.8V
- Charge pump can also power external LDO
- Low noise in 20Hz to 20kHz audio band
- Up to 200mA continuous output current
- Low operating and shutdown currents
- Stable with low-ESR ceramic or tantalum capacitors
- 10-Lead MSOP and TDFN packages
- Lead-free finishing

### Applications

- 5V analog supply for audio codec in notebook computers, PDAs, MP3 players, etc.
- 3.3V to 5V conversion in PCMCIA cards, PCI Express Cards, other applications needing 5V

### Block Diagram

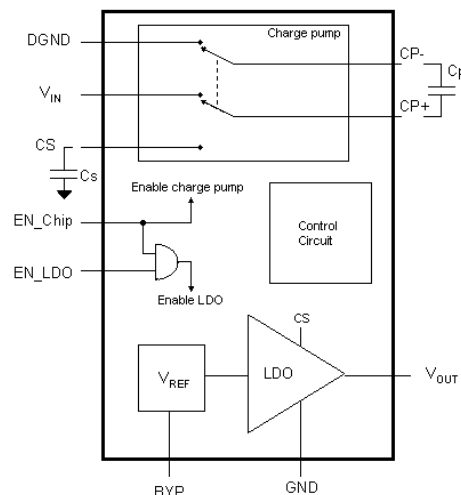

### Product Description

The CM3702 low-noise charge pump LDO regulator is designed to provide accurate and “clean” power to a subsystem, e.g an audio codec, LED driver, or flash memory. The 5V output provides up to 100mA continuous current for input voltages from 2.8V to 5.5V, and up to 200mA for a narrower range. This is accomplished with an integrated charge pump that boosts the input voltage before feeding it to an internal LDO linear regulator. The charge pump is designed to maintain a nominal 0.8V differential between the input and output of the LDO regulator. This allows the LDO regulator to operate with good power supply ripple rejection across the audio band while maintaining good power efficiency. The charge pump works with two external capacitors and operates at 250kHz, well outside the audible frequency band. In addition, separate analog and digital ground pins are provided for the charge pump and the rest of the circuitry to eliminate ground noise feed-through from the charge pump to the regulated output.

The CM3702 is fully protected, offering both overload current limiting and high temperature thermal shutdown. Two enable inputs provide flexibility in powering down the device. For maximum power saving in shutdown, both the charge pump and LDO regulator should be disabled. For applications that require the 5V output to be re-established with minimum delay after shutdown, the charge pump can be left enabled while the regulator is disabled. This avoids the delay that may otherwise be required for the charge pump to reach full operating voltage after being disabled. The CMOS LDO regulator features low quiescent current even at full load, making it very suitable for power sensitive applications.

A bandgap reference bypass pin is provided to further minimize noise by connecting an external capacitor between this pin and ground. Another, external, regulator can be connected to the charge pump output pin Cs, if required.

The CM3702 is available in 10-pin MSOP and TDFN packages, both with optional lead-free finishing, and are ideal for space critical applications.

### STANDARD PART ORDERING INFORMATION

Pins	Package	Standard Finish		Lead-free Finish	
		Ordering Part Number	Part Marking	Ordering Part Number	Part Marking
10	MSOP-10	CM3702-50MR	3702 50S	CM3702-50MS	3702 50
10	TDFN-10	CM3702-50DF	CM370 250DF	CM3702-50DE	CM370 250DE

## Pin Descriptions

**V<sub>IN</sub>** (pin 2) is the input power source for the device. Since the charge pump draws current in pulses at the 250kHz internal clock frequency, a low-ESR input decoupling capacitor is usually required close to this pin to ensure low noise operation.

**CP+** and **CP-** (pins 9, 10) are used to connect the external “flying” capacitor  $C_P$  to the charge pump. The charge stored in  $C_P$  is transferred to the reservoir capacitor  $C_S$  at the 250kHz internal clock rate.

**CS** (pin 3) is the output of the charge pump and is connected to the external reservoir capacitor  $C_S$ . This should be a low-ESR capacitor.

When the voltage on this pin reaches about 5.8V then the charge pump pauses until the voltage on this pin drops to about 5.7V. This gives rise to at least 100mV of ‘ripple’ (the frequency and amplitude of this ripple depends upon values of  $C_P$  and  $C_S$  and also the ESR of  $C_S$ ).

Note that current may be drawn from this pin for other applications (for example an additional, independent, 5V LDO) as long as the total current is less than 100mA (otherwise the part may overheat).

**DGND** (pin 1) is the ground for the charge pump circuit. This should be connected to the system (noisy) ground.

**GND** (pin 4) is the ground reference for all internal circuits except the charge pump. This pin should be connected to a “clean” low-noise analog ground.

**EN\_LDO**, **EN\_Chip** (pins 6, 7) are active-high TTL-level logic inputs to enable the linear regulator and charge pump according to the following truth table:

EN_Chip Pin 7	EN_LDO Pin 6	CHARGE PUMP	REGULATOR
1	1	Enabled	Enabled
1	0	Enabled	Disabled
0	1	Disabled	Disabled
0	0	Disabled	Disabled

When the LDO Regulator is disabled, an internal pull-down with a nominal resistance of 500Ω is activated to discharge the 5V output rail to ground.

When the charge pump is disabled or paused, the internal 250kHz oscillator is disabled. The “flying capacitor”  $C_P$  will then stay connected between  $V_{IN}$  and DGND, and  $C_S$  will stay connected to the input of the LDO regulator. In this mode,  $C_S$  will discharge at a rate determined by the input current of the LDO regulator.

**BYP** (pin 5) is connected to the internal voltage reference of the LDO regulator. An external bypass capacitor  $C_{BYP}$  of 0.1μF is recommended to minimize internal voltage reference noise and maximize power supply ripple rejection.

**V<sub>OUT</sub>** (pin 8) is the regulated output. An output capacitor may be added to improve noise and load-transient response. When the LDO regulator is disabled, an internal pull-down is activated to discharge the  $V_{OUT}$  rail to GND.

## Pinout Diagrams

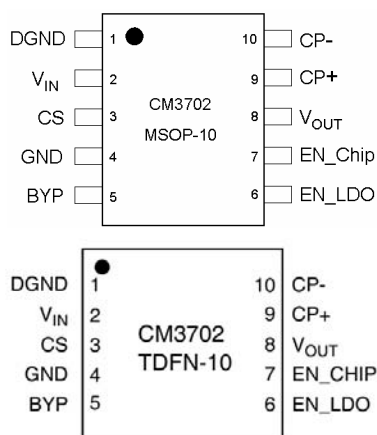

## Typical Application Circuit

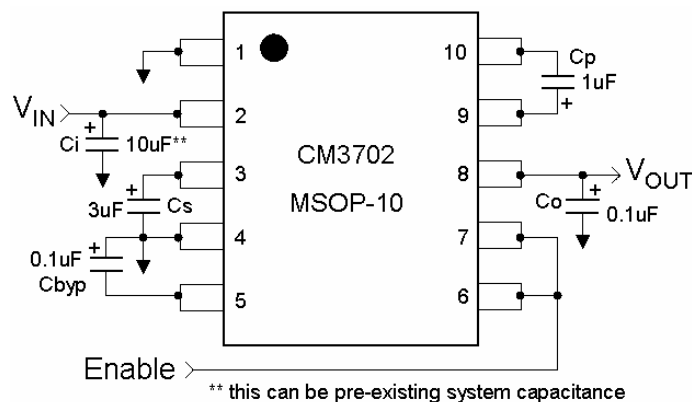

Absolute Maximum Ratings		
Parameter	Rating	Unit
ESD Protection (HBM)	2000	V
V <sub>IN</sub> , V <sub>OUT</sub> Voltages	+ 5.5, Gnd - 0.5	V
V <sub>EN</sub> Logic Input Voltage	V <sub>IN</sub> + 0.5, Gnd - 0.5	V
Temperature: Storage	-40 to +150	°C
Operating Ambient	0 to +70	
Operating Junction	0 to +170	

Standard Operating Conditions		
Parameter	Range	Unit
V <sub>IN</sub> - Input Voltage Range	3.0 to 5.5	V
Ambient Operating Temperature	0 to +70	°C
θ <sub>JA</sub> of MSOP package on pcb	200 (approx)	°C/W
I <sub>OUT</sub> - Output Load Current	0 to 200	mA
C <sub>BYP</sub>	0.1	μF
C <sub>OUT</sub>	0 to 100	μF

Electrical Operating Characteristics						
(V <sub>IN</sub> = 5.0V; I <sub>OUT</sub> = 100mA; C <sub>OUT</sub> = 10μF; C <sub>P</sub> = 1μF; C <sub>S</sub> = 10μF; unless specified otherwise)						
Symbol	Parameter	Conditions	MIN	TYP	MAX	UNIT
V <sub>CS</sub>	Charge pump output voltage	V <sub>OUT</sub> = 5V, 1mA ≤ I <sub>OUT</sub> ≤ 100mA;	5.5	5.8	7	V
V <sub>OUT</sub>	Regulator Output Voltage	V <sub>IN</sub> = 4.0V; 1mA ≤ I <sub>OUT</sub> ≤ 100mA;	4.85		5.15	V
V <sub>RLOAD</sub>	Load Regulation	I <sub>OUT</sub> = 1mA to 100mA		0.2		%
V <sub>RLINE</sub>	Line Regulation	Vary V <sub>IN</sub> from 3.0V to 5.0V		0.02		%
R <sub>DISCHG</sub>	V <sub>OUT</sub> Discharge Resistance	LDO regulator disabled EN2 (pin 6) grounded; V <sub>IN</sub> = 5V		500		Ω
I <sub>GND</sub>	LDO Regulator Ground Current via GND pin	Shutdown (EN2 grounded)		1	10	μA
		Regulator Enabled, I <sub>OUT</sub> = 0mA		180		μA
		Regulator Enabled, I <sub>OUT</sub> = 100mA		180		μA
I <sub>DGND</sub>	Charge Pump Shutdown Current via DGND pin	EN1 (pin 7) grounded, V <sub>IN</sub> = 5.0V		1	10	μA
PSRR	Power Supply Rejection	I <sub>OUT</sub> = 100mA; C <sub>BYP</sub> = 0.1μF		42		dB
		f = 100Hz f = 10kHz		42		dB
e <sub>NO</sub>	Output Voltage Noise	BW = 22Hz-22kHz; C <sub>OUT</sub> = 10μF; C <sub>BYP</sub> = 0.1μF; I <sub>OUT</sub> = 100mA		35		μVrms
e <sub>NO</sub>	Output Voltage Noise	BW = 22Hz-22kHz; C <sub>p</sub> = 1μF, C <sub>S</sub> = 3μF C <sub>OUT</sub> = C <sub>BYP</sub> = 0.1μF; I <sub>OUT</sub> = 100mA		38		μVrms
V <sub>IH</sub>	EN1, EN2 Input High threshold	V <sub>IN</sub> = 5.0V	2.0			V
V <sub>IL</sub>	EN1, EN2 Input Low threshold	V <sub>IN</sub> = 5.0V			0.5	V
I <sub>LIM</sub>	Overload Current Limit	(LDO only)	200	300		mA
I <sub>SC</sub>	Output Short Circuit Current	(LDO only)	100	200		mA
T <sub>JSD</sub>	Thermal Shutdown Junction Temp			170		°C
T <sub>HYS</sub>	Thermal Shutdown Hysteresis			25		°C

Typical Performance Characteristics (T=25°C)

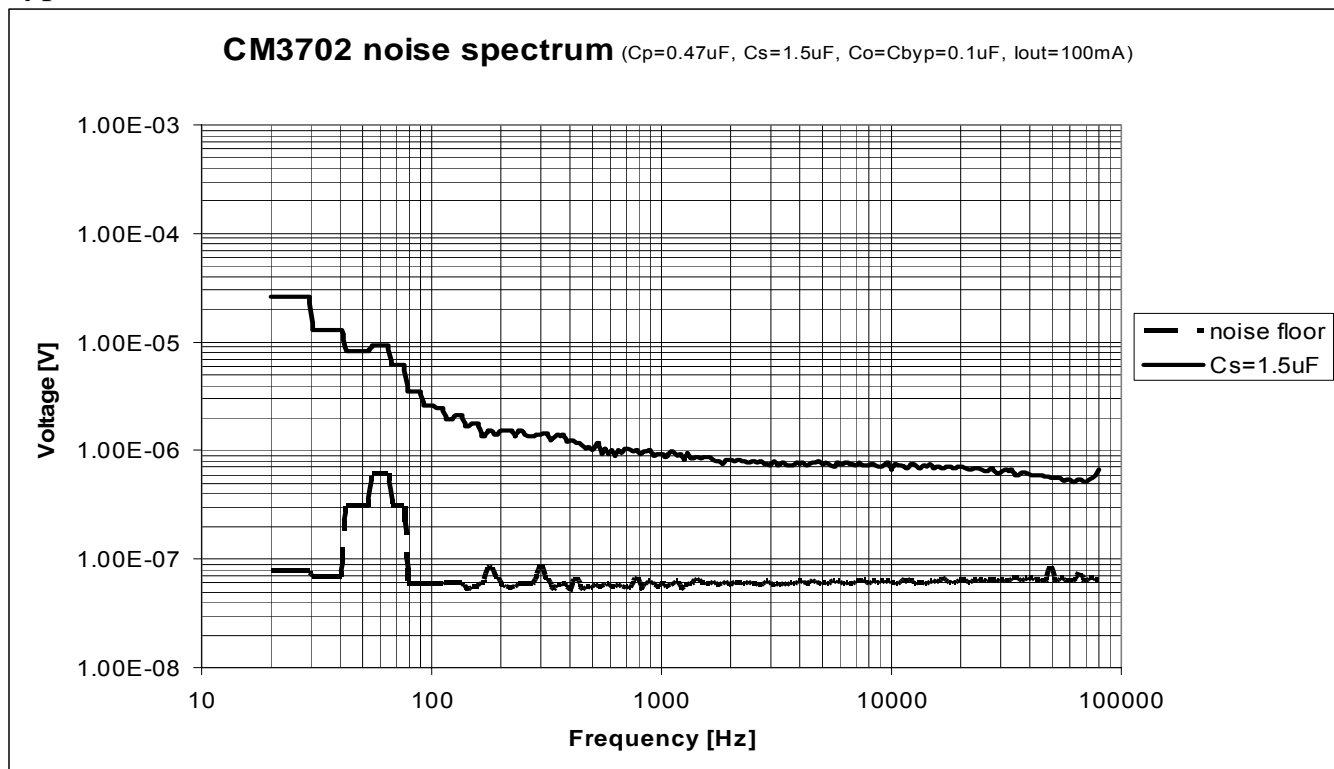

Note: Noise peaks may appear for different values of  $C_p$ ,  $C_s$  &  $I_{OUT}$ , and are due to the ripple frequency of the charge pump (see later).

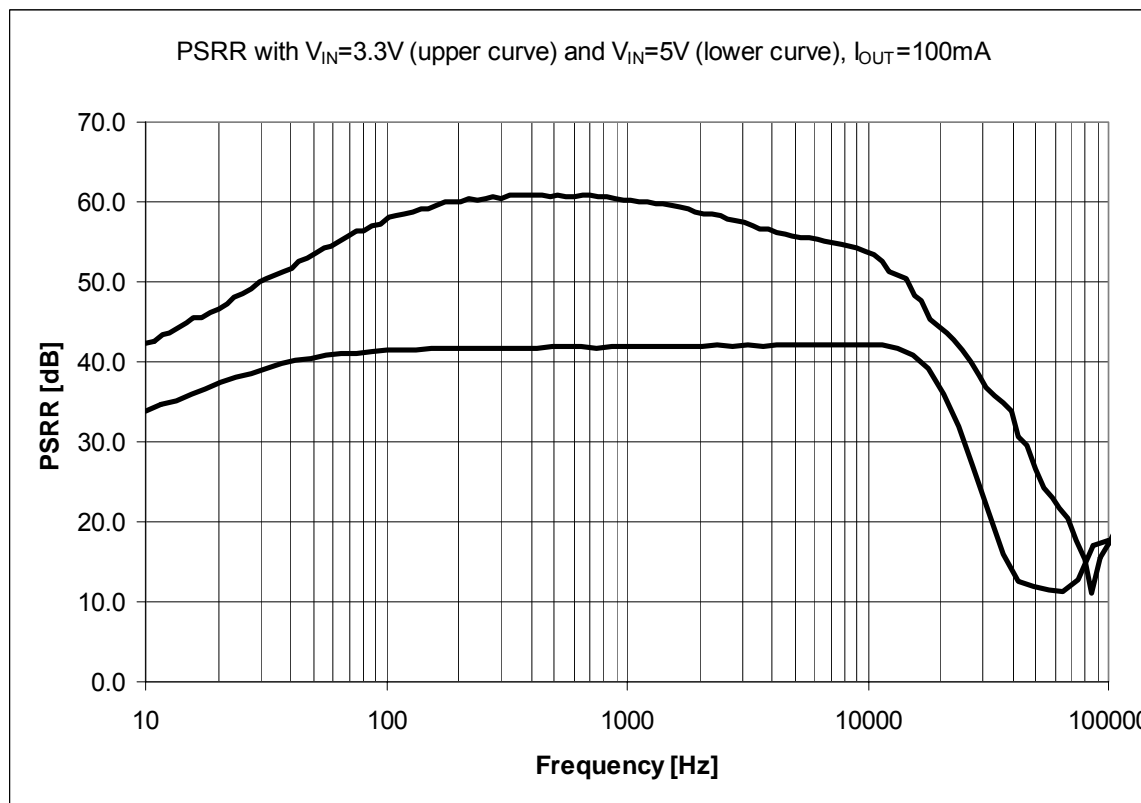

Measured by forcing  $V_{IN}$  voltage to 3.3V & 5.0V dc, then sweeping 100mV ac on  $V_{IN}$ .  $C_{OUT} = 10\mu F$ ,  $C_{BYP} = 0.1\mu F$

Typical Performance Characteristics (T=25°C, Cp=1uF, Cs=10uF, Cbyp=0.1uF, C\_OUT=10uF unless stated)

V\_OUT vs. I\_OUT (V\_IN = 5V)

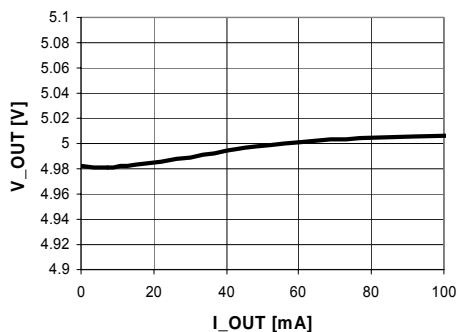

V\_EN Threshold vs. V\_IN

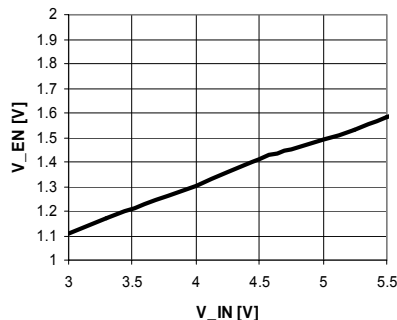

V\_OUT vs. V\_IN

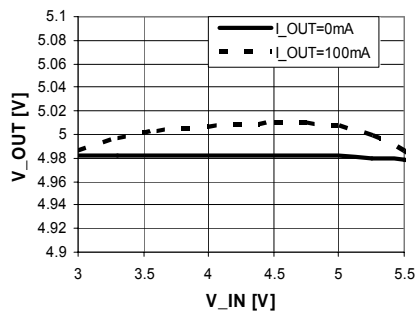

I\_IN vs. V\_IN

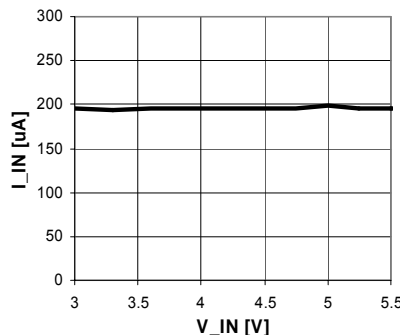

CS pin vs. V\_IN

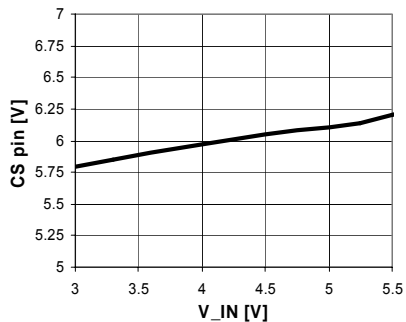

I\_IN vs. I\_OUT

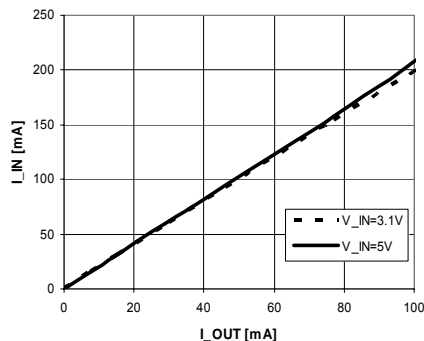

DROPOUT VOLTAGE (LDO ONLY)  
at T=150°C, T=85°C and T=25°C

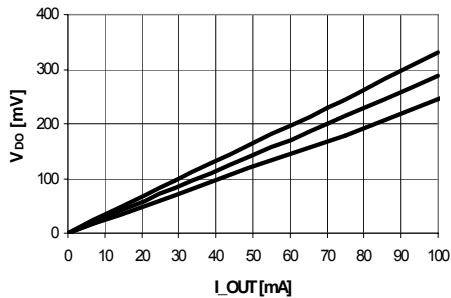

Overcurrent characteristic (LDO only)

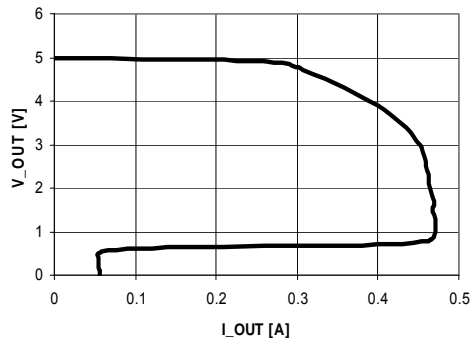

Typical Performance Characteristics (T=25°C, Cp=1uF, Cs=10uF, Cbyp=0.1uF, C\_OUT=10uF unless stated)

### LOAD REGULATION (0 to 100mA)

Tek **Stop:** Single Seq 1.00kS/s

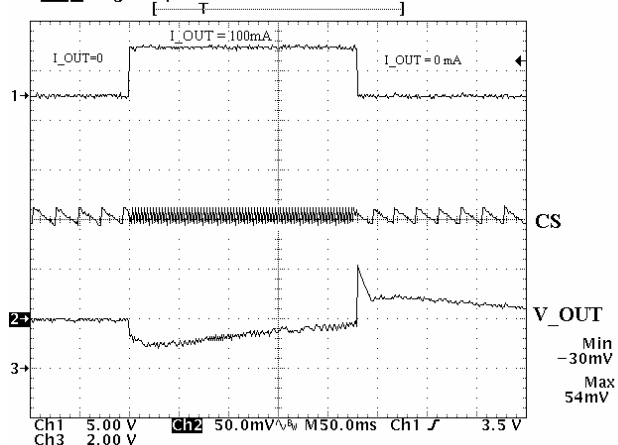

### COLD START / POWER-UP

Tek **Stop:** Single Seq 2.50kS/s

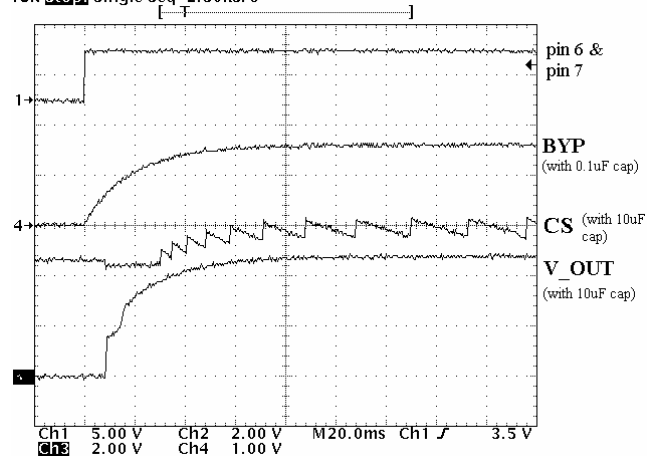

### LOAD REGULATION (2mA to 100mA)

Tek **Stop:** Single Seq 1.00kS/s

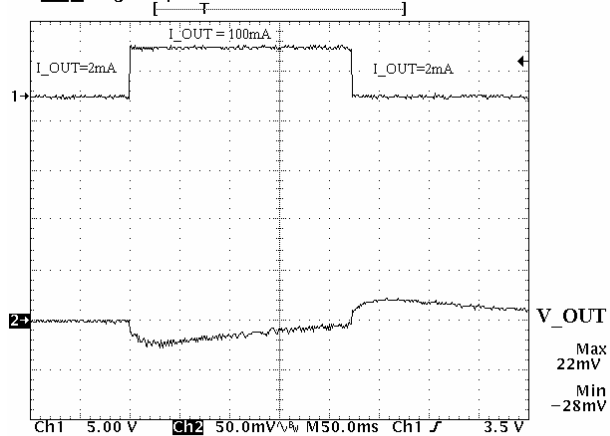

### LDO POWER-UP

Tek **Stop:** 2.50MS/s 3 Acqs

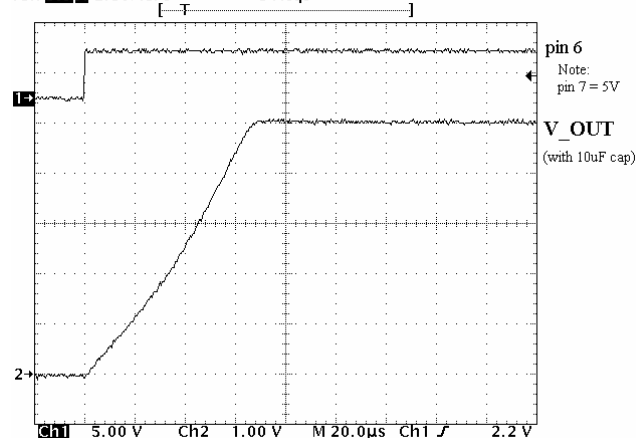

### LINE REGULATION

Tek **Stop:** 2.50kS/s 154 Acqs

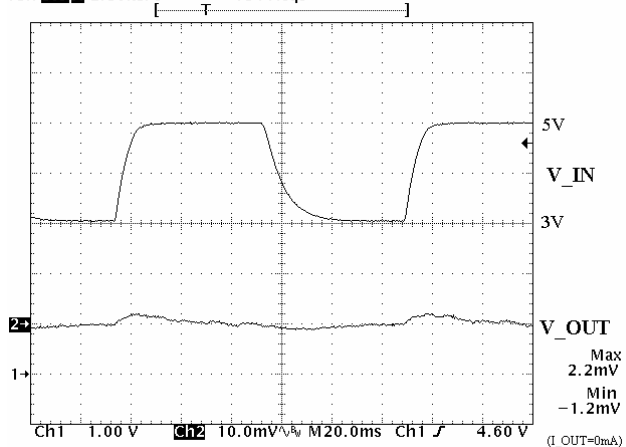

### LDO POWER-DOWN

Tek **Stop:** 25.0kS/s 3 Acqs

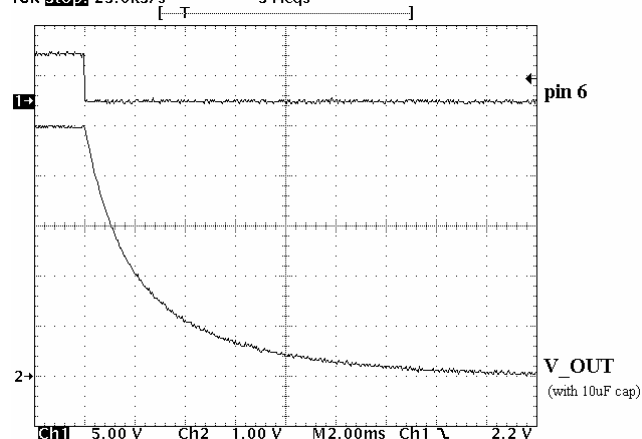

Typical Performance Characteristics ( $V_{IN}=5V$ ,  $C_p=1\mu F$ ,  $C_s=10\mu F$ ,  $C_{byp}=0.1\mu F$ ,  $C_{OUT}=10\mu F$  unless stated)  
 Note: temperature quoted is ambient temperature, not die temperature

**V\_OUT with V\_IN = 5V**

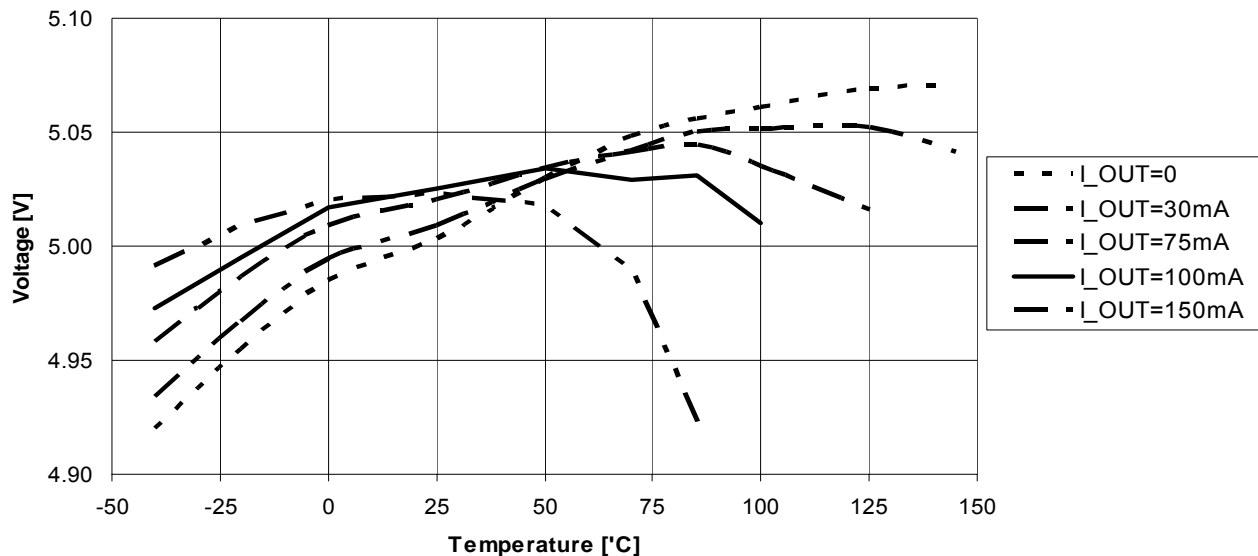

**V\_OUT with V\_IN = 3.0V, I\_OUT = 100mA**

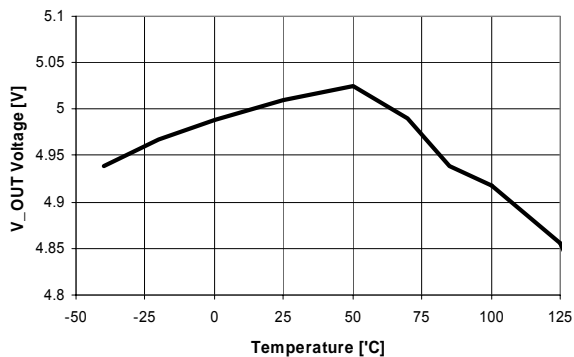

**I\_IN Leakage current (Pins 6, 7 = 0V)**

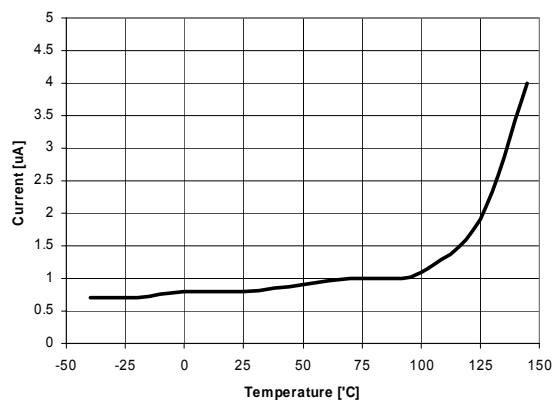

**Bypass pin voltage**

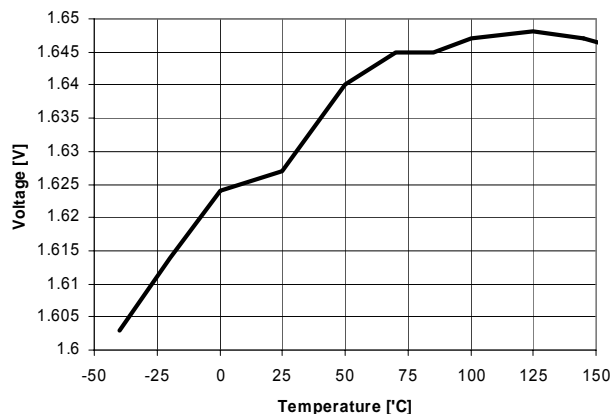

**Undervoltage lockout**

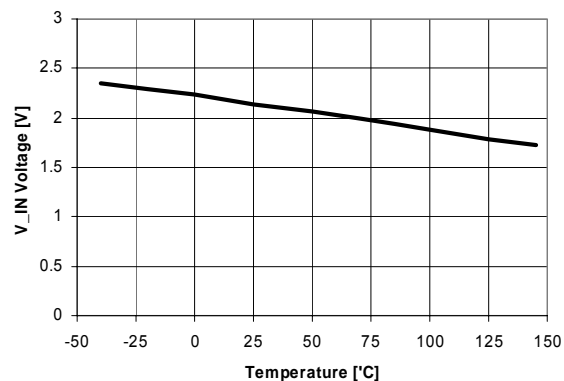

## Applications Information

### Ripple Frequency

The charge pump internal oscillation frequency is about 250kHz. However, this is the continuous, free-running frequency, which is usually only seen while the charge pump is powering up. After the charge pump output voltage (CS) reaches approximately 5.8V, the charge pump pauses until the CS voltage drops to approximately 5.7V. Then the charge pump restarts and runs until the CS voltage is greater than approximately 5.8V, when it pauses again, and this process repeats. This gives rise to a sawtooth 'ripple' waveform on CS which can have a much lower frequency than 250kHz. This mode of operation is necessary to conserve power – if it were not done this way then a much larger package with heatsink would be required.

The frequency of this 'ripple' is affected by V<sub>IN</sub>, I<sub>OUT</sub>, Cs capacitor value and Cp capacitor value.

### Guidelines for choosing values for external capacitors.

(1) To find Cp: specify value of V<sub>IN</sub>, and highest value of I<sub>OUT</sub>:

If V<sub>IN</sub>= 3.3V +/- 5%, then **minimum** value of Cp(μF) = I<sub>OUT</sub>(mA) / 85

If V<sub>IN</sub>= 5.0V +/- 10%, then **minimum** value of Cp(μF) = I<sub>OUT</sub>(mA) / 700

(2) Ci, the V<sub>IN</sub> decoupling capacitor, should typically be much greater than Cp to prevent voltage droop during Cp charging.

Excessive glitches on V<sub>IN</sub> will affect the output voltage V<sub>OUT</sub>.

Typically Ci is 10X greater than Cp. But usually there are already some capacitors on this supply, so adding extra capacitors is not necessary – simply move an already-present low-ESR capacitor close to the CM3702.

This is especially important for V<sub>IN</sub> = 5V.

(3) Choose value of Cs. Cs should be small to ensure that the ripple frequency is high, but Cs should be at least 2x greater than Cp otherwise the ripple amplitude will be very high. Reducing the value of Cs will increase the ripple frequency.

Examples of Cs ripple frequencies: (Cs=10μF, 25°C)

Cp=0.47μF	
V <sub>IN</sub> =3.14, I <sub>OUT</sub> =15mA	CS Frequency=46kHz
V <sub>IN</sub> =3.60, I <sub>OUT</sub> =15mA	CS Frequency=35kHz
V <sub>IN</sub> =4.50, I <sub>OUT</sub> =70mA	CS Frequency=76kHz
V <sub>IN</sub> =5.50, I <sub>OUT</sub> =70mA	CS Frequency=56kHz

Cp=1μF	
V <sub>IN</sub> =3.14, I <sub>OUT</sub> =100mA	CS Frequency=250kHz
V <sub>IN</sub> =3.60, I <sub>OUT</sub> =100mA	CS Frequency=110kHz
V <sub>IN</sub> =4.50, I <sub>OUT</sub> =100mA	CS Frequency=67kHz
V <sub>IN</sub> =5.50, I <sub>OUT</sub> =100mA	CS Frequency=49kHz

(4) Co, the V<sub>OUT</sub> decoupling capacitor helps minimize noise and improve load regulation. 0.1μF - 100μF recommended.

(5) Cbyp, the bypass capacitor helps reduce noise in the LDO. 0.1μF recommended.

After choosing external component values, check in-system performance (at min/max V<sub>IN</sub>, max temperature, and min/max I<sub>OUT</sub>). See troubleshooting guide on next page for tips if there are problems.

### Charge Pump Noise

The charge pump is 'digital' in operation and can produce digital noise at both the free-running frequency and at the ripple frequency.

To minimize noise PCB grounding is important! This part requires short, low-impedance ground connections for DGND (pin 1), GND (pin 4), the V<sub>IN</sub> decoupling capacitor (pin 2), the CS capacitor (pin 3), the Bypass decoupling capacitor (pin 5) and the V<sub>OUT</sub> decoupling capacitor (pin 8). All decoupling capacitors and the Cs capacitor should be low-ESR ceramics.

The Cp capacitor does NOT need to be low-ESR.

### Efficiency

The power efficiency in % of the combined charge pump and LDO is approximately:

$$100 * (V_{OUT}) / (V_{IN} * 2)$$

### Power Dissipation

The dissipation of the part is approximately:

$$((V_{IN} * 2) - V_{OUT}) * I_{OUT}$$



The MSOP-10 package heats at a rate of about 200°C/W ( $\theta_{JA}$ ). (Note that this value is approximate because it depends upon the copper tracks and ground planes on the pcb.) If  $V_{IN} = 5V$  and  $I_{OUT} = 100mA$  then the power dissipation will be approximately 500mW. Multiplying this by the  $\theta_{JA}$  of 200, the part's internal temperature will be about 100°C higher than the ambient temperature. If the ambient temperature is 70°C then the internal temperature will be approximately 170°C which will typically trigger the overtemperature circuit and depower the part.

$$\text{Internal temperature} = \text{Ambient temperature} + ( \theta_{JA} * \text{Power dissipation} )$$

(Must be less than 170°C)

Note that the evaluation pcb has a  $\theta_{JA}$  of less than 150°C/W, based upon measured performance.

### How to reduce the power dissipation of the part, and how to get more than 100mA

If  $V_{IN} = 5V$  typ., then the charge pump / LDO combination is capable of providing more than 100mA. The only problem is power dissipation.

If the input voltage is lowered using an external diode then the output current can be increased without causing the part to overheat:

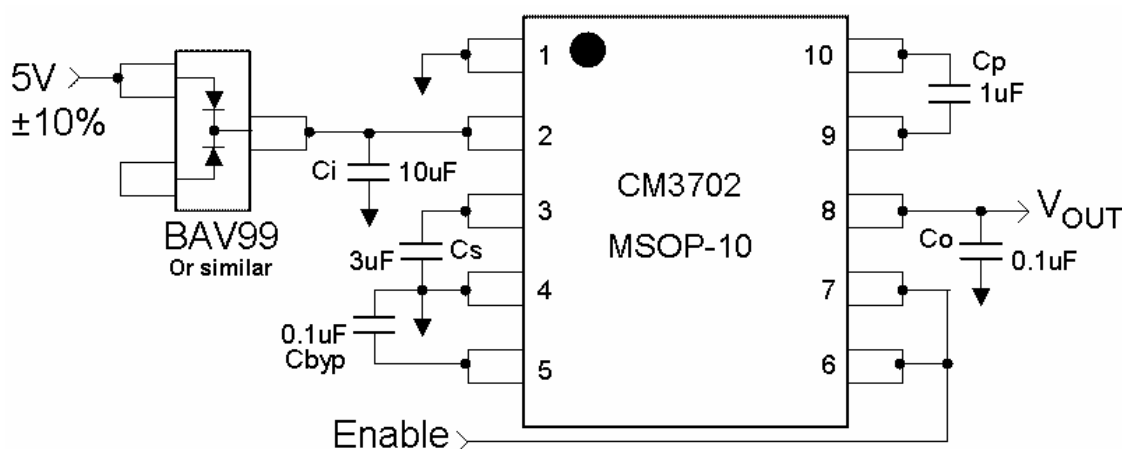

Using this circuit  $I_{OUT}$  can be 200mA if  $V_{IN} = 4.75V$ , and yet the part will not overheat even if  $V_{IN} = 5.25V$ ,  $I_{OUT}=200mA$  and the ambient temperature is 85°C.

### Warnings

The charge pump output CS (pin 3) must not be shorted to GND or held below its internally-set voltage while the part is powered. This usually results in the destruction of the part.

With  $V_{IN} = 5V$ , the maximum current that can be continuously drawn from CS is approximately 100mA dc.

Never short Cp+ (pin 9) to Cp- (pin 10). This will cause large currents to flow from  $V_{IN}$  to DGND through the part, usually causing its destruction. This will happen even if EN\_Chip and EN\_LDO are off.

### Troubleshooting Guide

1. Is the output voltage is drooping under heavy loads? Perhaps the charge pump cannot provide the necessary current. Try increasing the value of Cp. If that does not work then is  $V_{IN}$  too low? Is  $V_{IN}$  drooping during the Cp charging cycle? If  $V_{IN}$  is not suitably decoupled and drops below 3.1V then the available current will be very low.
2. Is the output voltage oscillating between 5V and 0V? The part may be reaching its overtemperature limit. Reduce current consumption, reduce  $\theta_{JA}$  or add an external diode on the input to reduce  $V_{IN}$ .
3. Is the part too noisy? Try increasing value (or reducing ESR) of Cs, Ci, Co, Cb. At minimum current the charge pump ripple frequency will be low. If  $V_{OUT}$  noise is at the charge pump ripple frequency then change values of Cp and Cs. Reducing the input voltage  $V_{IN}$  will reduce the charge pump ripple frequency noise on  $V_{OUT}$ .
4. Will the part power up? Pin 6 must be HIGH to power up. Even if pin 7 is HIGH, pin 6 must also be high to power up.
5. Can the cold start power-up time be reduced? Yes, by reducing the value of the BYP capacitor.

## Mechanical Details

### MSOP Mechanical Specifications:

The CM3702-50MR/MS is supplied in a 10-pin MSOP package. Dimensions are presented below.

For complete information on the MSOP-10 package, see the California Micro Devices MSOP Package Information document.

PACKAGE DIMENSIONS				
Package	MSOP			
Pins	10			
Dimensions	Millimeters		Inches	
	Min	Max	Min	Max
A	0.75	0.95	0.028	0.038
A1	0.05	0.15	0.002	0.006
B	0.18	0.40	0.006	0.016
C	0.18		0.007	
D	2.90	3.10	0.114	0.122
E	2.90	3.10	0.114	0.122
e	0.50 BSC		0.0196 BSC	
H	4.76	5.00	0.187	0.197
L	0.40	0.70	0.0137	0.029
# per tube	80 pieces*			
# per tape and reel	4000			
Controlling dimension: inches				

\* This is an approximate number which may vary.

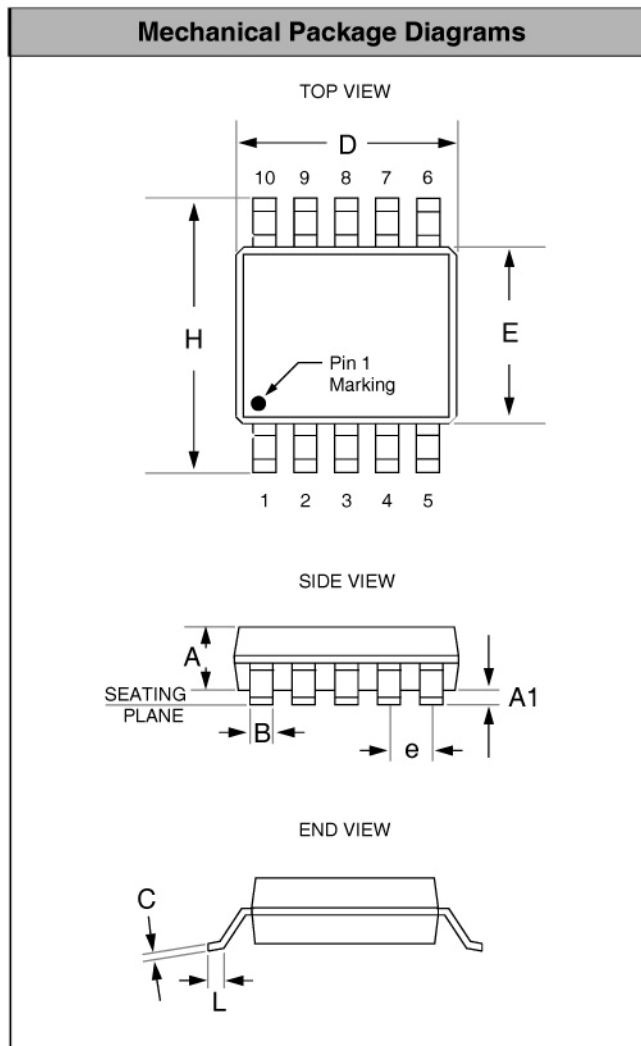

**Package Dimensions for MSOP-10**

## Mechanical Details

### TDFN-10 Mechanical Specifications

The CM3702-50DF/DE is supplied in a 10-lead TDFN package. Dimensions are presented below.

For complete information on the TDFN-10, see the California Micro Devices TDFN Package Information document.

PACKAGE DIMENSIONS						
Package	TDFN					
JEDEC No.	MO-229 (Var. WEED-3) <sup>†</sup>					
Leads	10					
Dim.	Millimeters			Inches		
	Min	Nom	Max	Min	Nom	Max
A	0.70	0.75	0.80	0.028	0.030	0.031
A1	0.00	0.02	0.05	0.000	0.001	0.002
A2	0.45	0.55	0.65	0.018	0.022	0.026
A3		0.20			0.008	
b	0.18	0.25	0.30	0.007	0.010	0.012
D		3.00			0.118	
D2	2.20	2.30	2.40	0.087	0.091	0.094
E		3.00			0.118	
E2	1.40	1.50	1.60	0.055	0.060	0.063
e		0.50			0.020	
K	1.30	1.50	1.70	0.051	0.060	0.067
L	0.20	0.30	0.40	0.008	0.012	0.016
# per tube	NA					
# per tape and reel	3000 pieces					
Controlling dimension: millimeters						

<sup>†</sup>This package is compliant with JEDEC standard MO-229, variation WEED-3 with exception of the "D2" and "E2" dimensions as called out in the table above.

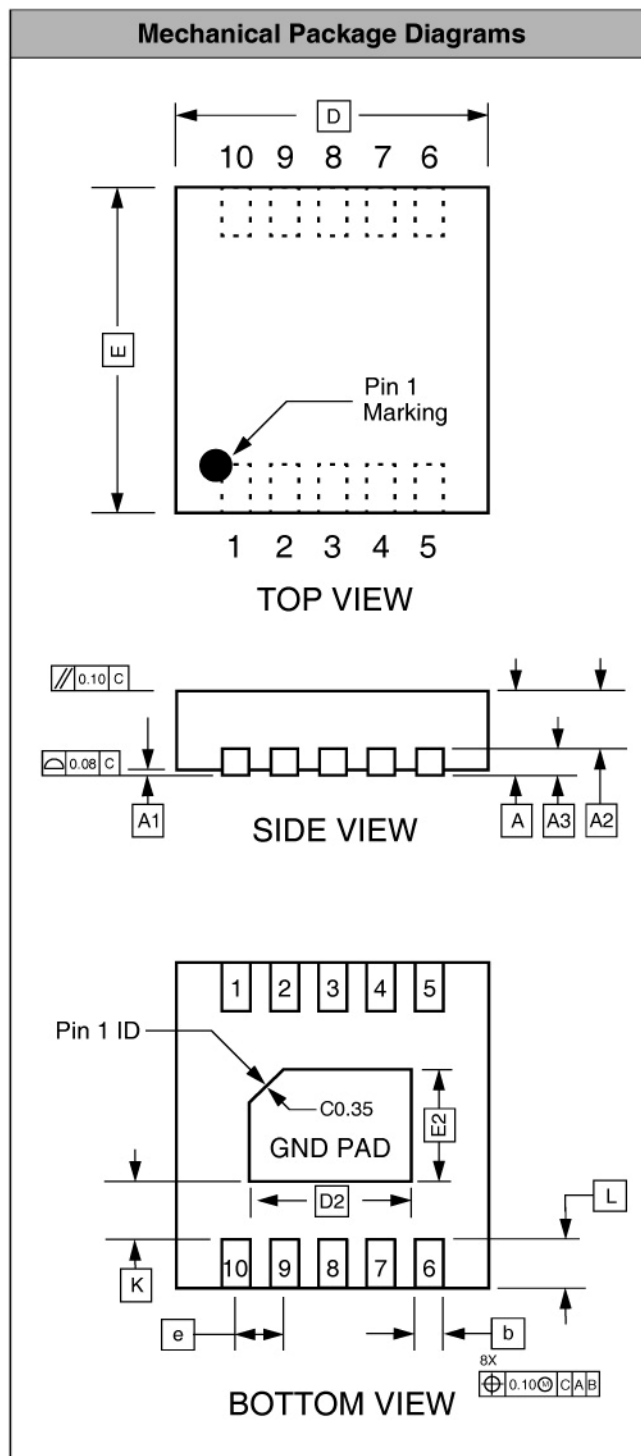

**Package Dimensions for 10-Lead TDFN**