

NF3000A-YXS Series (RoHS Compliant)

3-phase 3-line 250VAC

Space saving Book type



UL1283 (file No.E102708)
EN60939-2 (file No.R50031314)

Applications

Semiconductor equipment, Machin tool, General-purpose inverter and servo
Power source for CVCF, Power source for elevator, Factory

Specifications

Part No.	Rated Current	Weight	Dimensions [mm]												
			A	B	C	D	E	F	G	H	J	K	L	M	
NF3010A-YXS	10A	0.5kg	110	100	50	40	95	M4	M4	M4	R2.25x6	dia.4.5	9	11	fig1
NF3020A-YXS	20A														
NF3030A-YXS	30A														
NF3040A-YXS	40A	0.8kg	128	120	65	55	95	M5	M5	M4	R2.25x6	dia.4.5	13	16	
NF3050A-YXS	50A														
NF3060A-YXS	60A														
NF3080A-YXS	80A	1.6kg	fig2												
NF3100A-YXS	100A														
NF3125A-YXS	125A	2.8kg	fig3												
NF3150A-YXS	150A														
NF3200A-YXS	200A	6.9kg	fig4												
NF3250A-YXS	250A	8.1kg	fig4												
NF3300A-YXS	300A														
Rated Voltage	250VAC max														
Leakage Current	1.5mA max 200VAC 60Hz By UL1283														
Ambient temp.	-20 up to 50 Deg.C														

fig.1 (10A~60A)

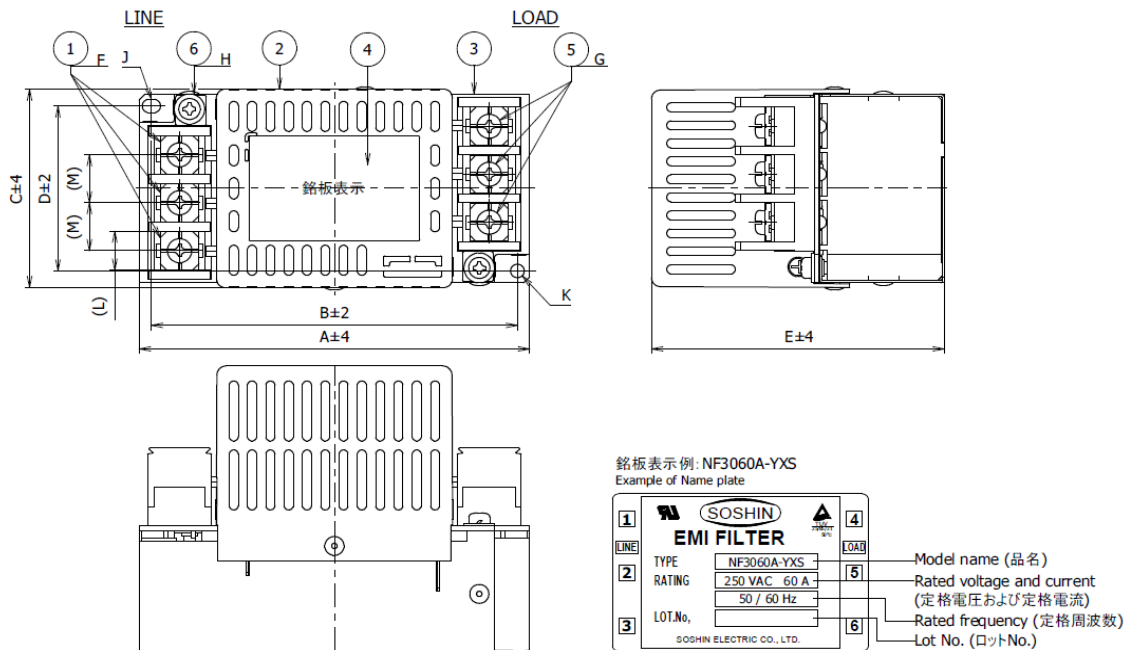

fig.2 (80A, 100A)

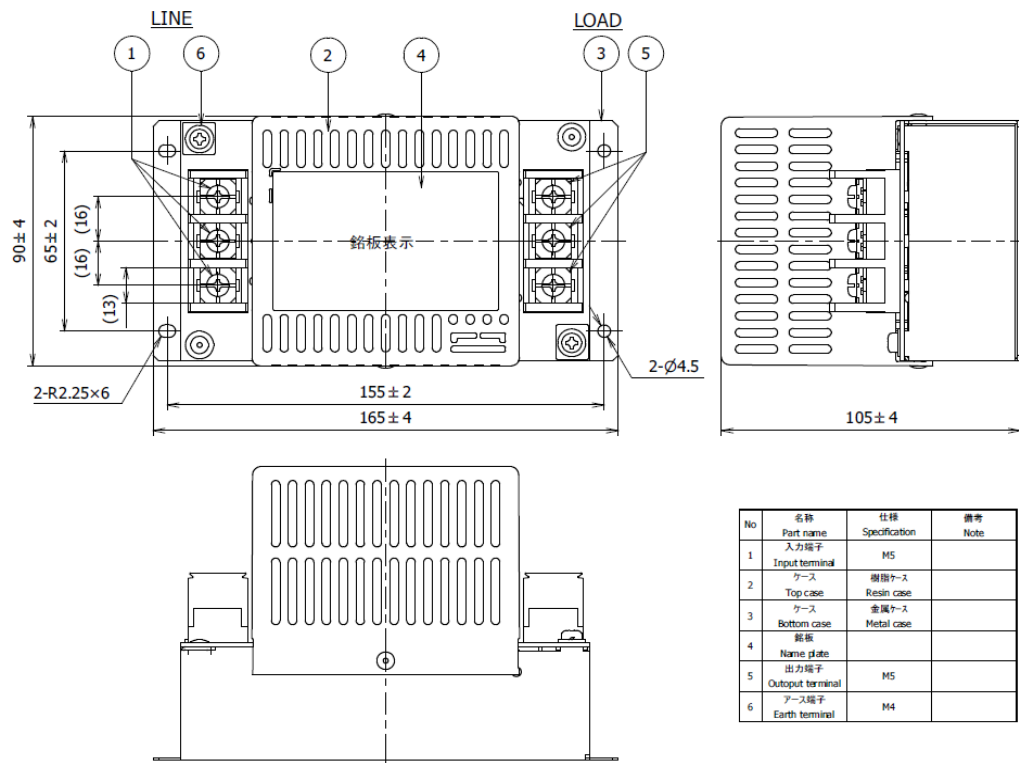

fig. 3 (125A, 150A)

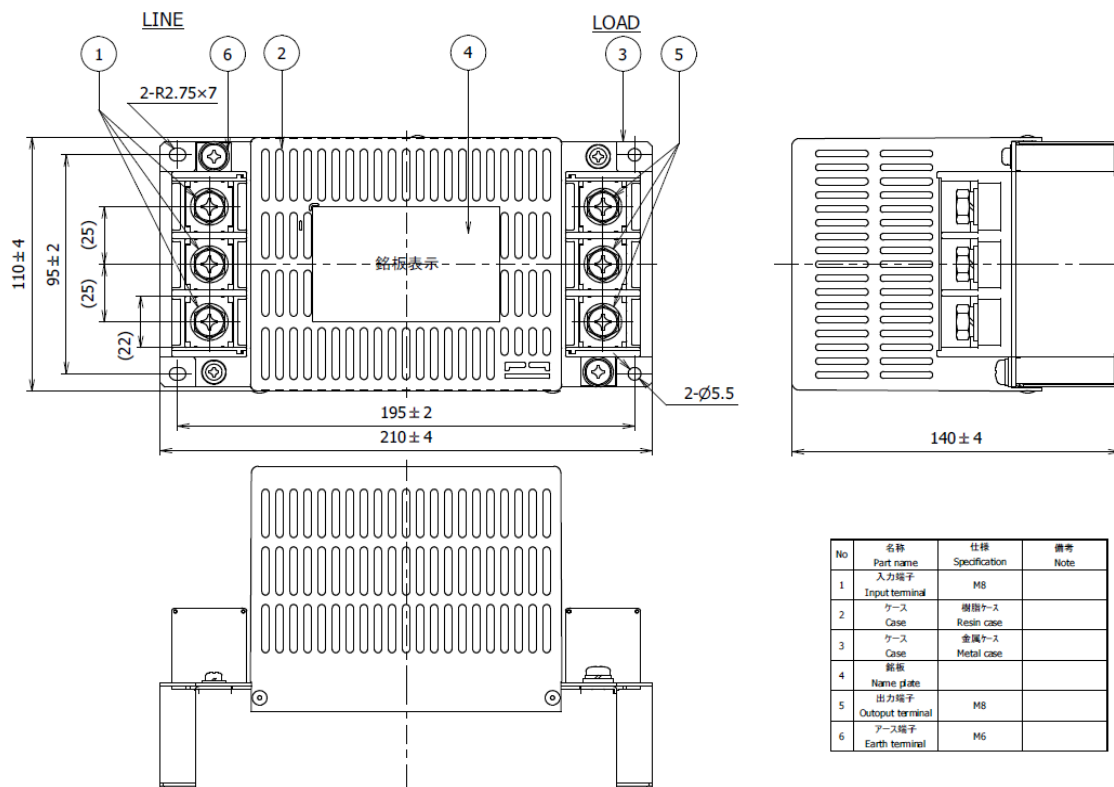
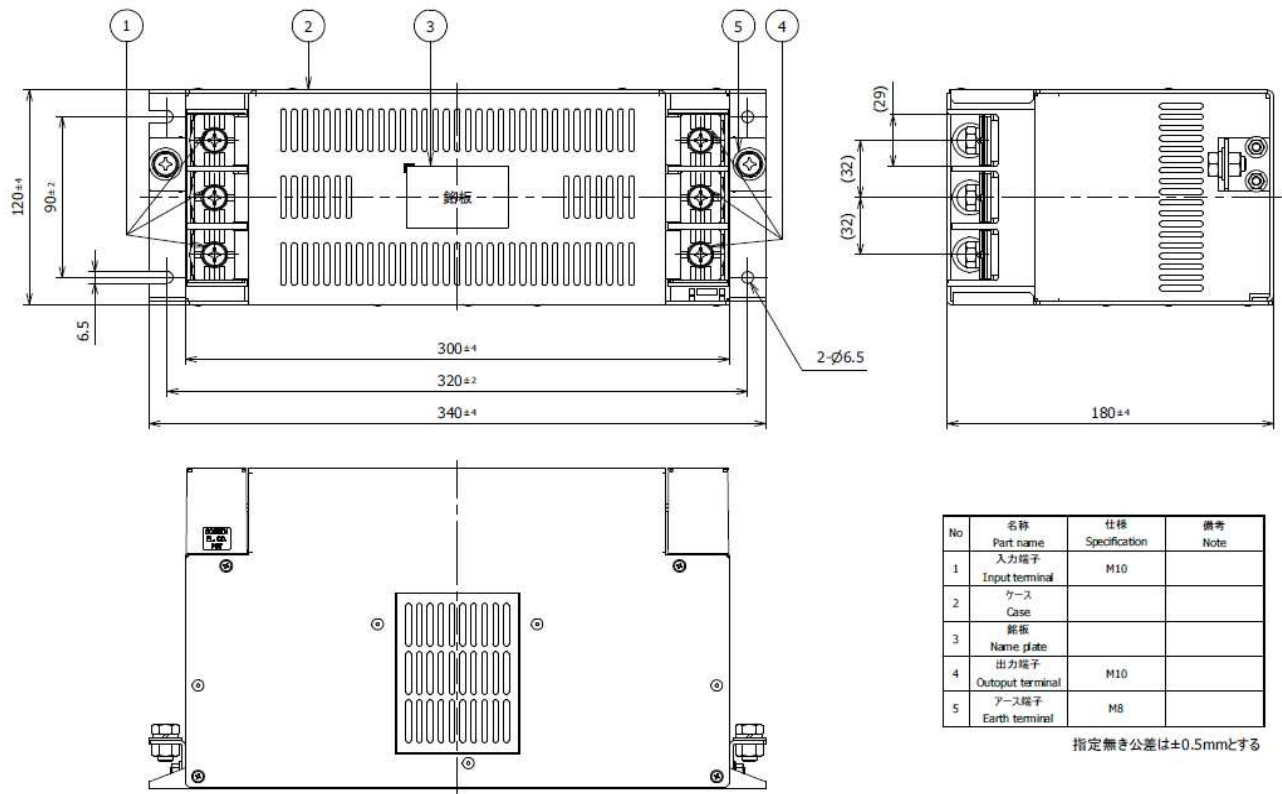
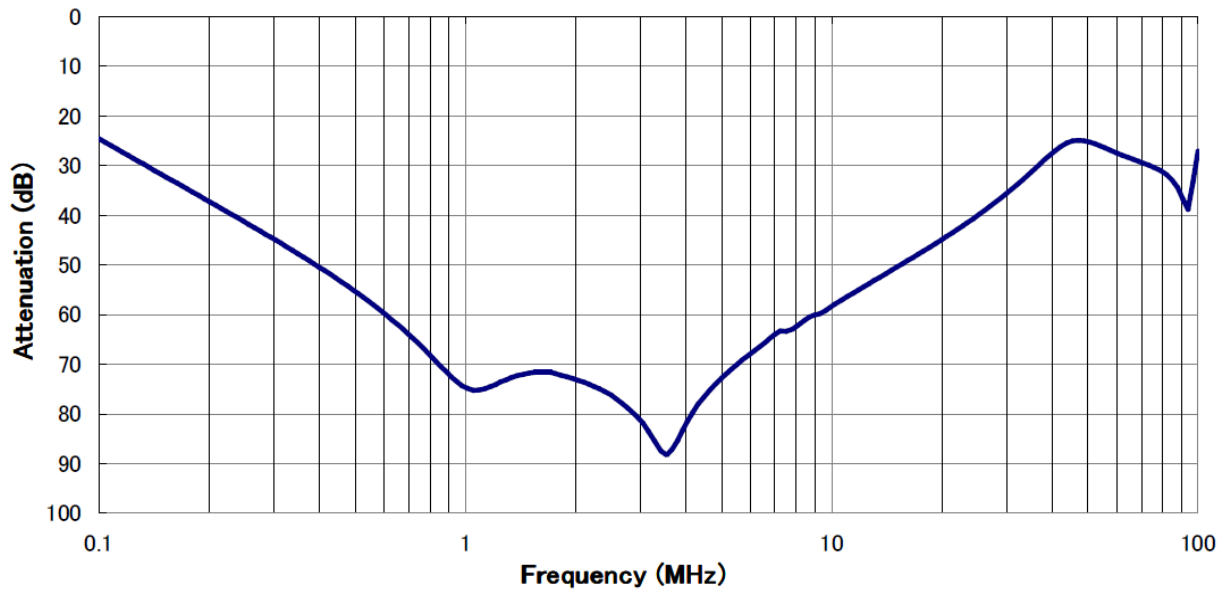

fig. 4 (200A~300A)



Characteristics (Typical) (10A, 20A, 30A)



Characteristics (Typical) (40A, 50A, 60A)

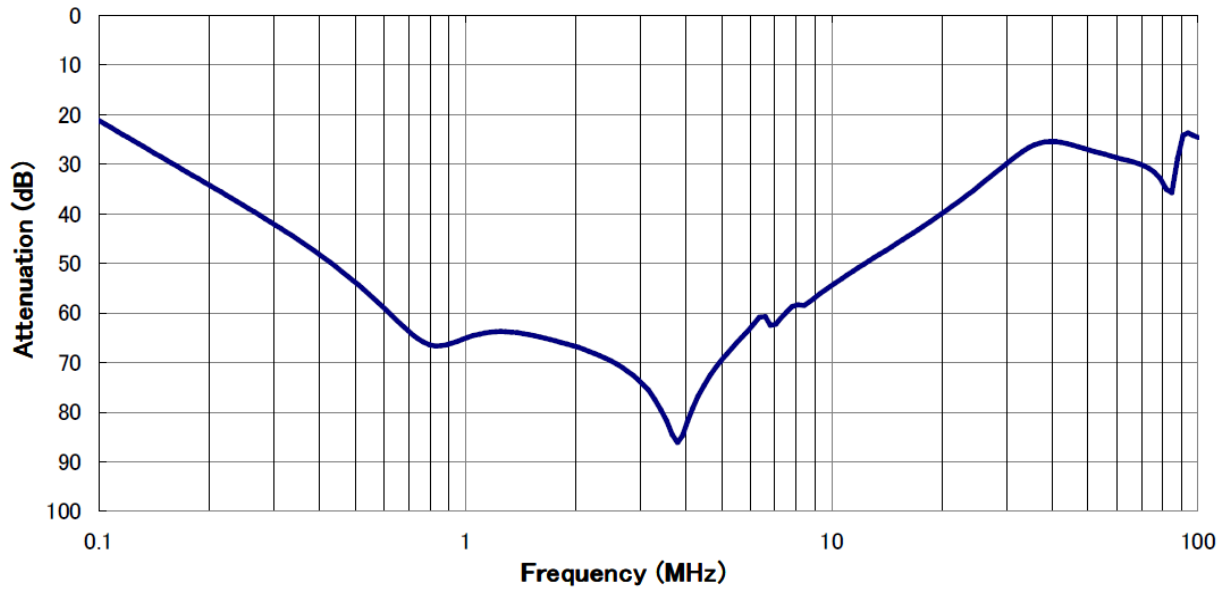

Characteristics (Typical) (80A, 100A)

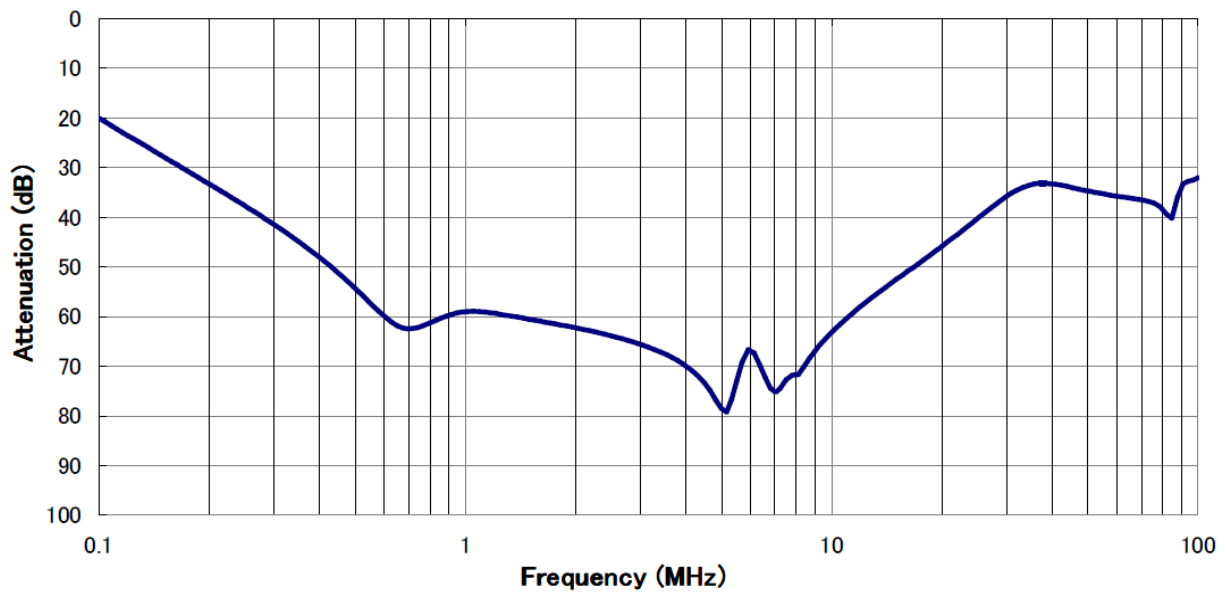

Characteristics (Typical) (125A, 150A)

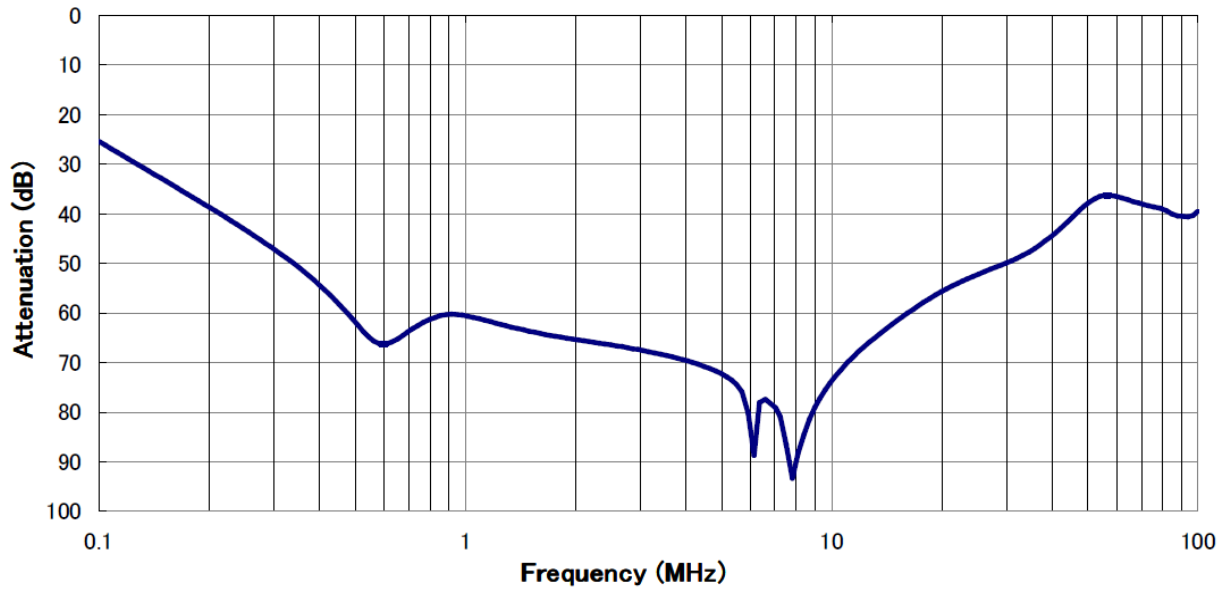

Circuit Diagram

