



## 2N7002

Power MOSFET

### 0.3A, 60V N-CHANNEL POWER MOSFET

#### DESCRIPTION

The UTC **2N7002** uses advanced technology to provide excellent  $R_{DS(ON)}$ , low gate charge and operation with low gate voltages. This device is suitable for use as a load switch or in PWM applications.

#### FEATURES

- \* High Density Cell Design for Low  $R_{DS(ON)}$ .
- \* Voltage Controlled Small Signal Switch
- \* Rugged and Reliable
- \* High Saturation Current Capability

#### SYMBOL

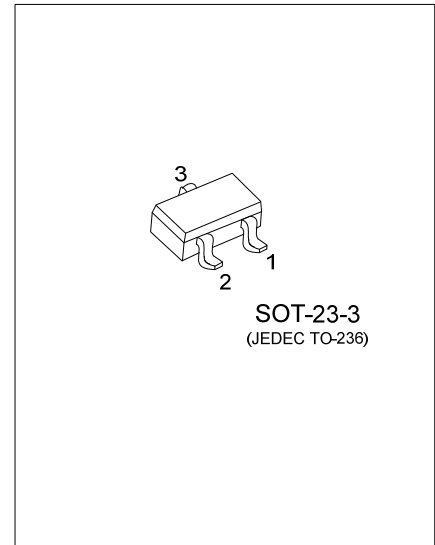
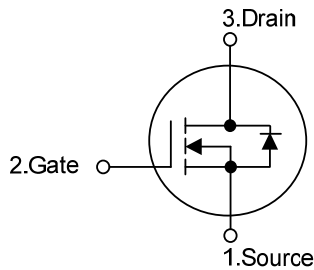

#### ORDERING INFORMATION

Ordering Number	Package	Pin Assignment			Packing
		1	2	3	
2N7002G-AE2-R	SOT-23-3	S	G	D	Tape Reel

Note: Pin Assignment: G: Gate D: Drain S: Source

2N7002G-AE2-R	(1)Packing Type	(1) R: Tape Reel
	(2)Package Type	(2) AE2: SOT-23-3
	(3)Green Package	(3) G: Halogen Free and Lead Free

#### MARKING

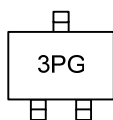

■ ABSOLUTE MAXIMUM RATINGS ( $T_A=25^\circ\text{C}$ , unless otherwise specified.)

PARAMETER	SYMBOL	RATINGS	UNIT
Drain-Source Voltage	$V_{DSS}$	60	V
Drain-Gate Voltage ( $R_{GS} \leq 1\text{M}\Omega$ )	$V_{DGR}$	60	V
Gate Source Voltage	$V_{GSS}$	Continuous	$\pm 20$
		Non Repetitive ( $t_P < 50\mu\text{s}$ )	$\pm 40$
Drain Current	$I_D$	Continuous	300
		Pulsed	800
Power Dissipation	$P_D$	200	mW
Derated Above $25^\circ\text{C}$		1.6	$\text{mW}/^\circ\text{C}$
Junction Temperature	$T_J$	+ 150	$^\circ\text{C}$
Storage Temperature	$T_{STG}$	-55 ~ +150	$^\circ\text{C}$

Note: Absolute maximum ratings are those values beyond which the device could be permanently damaged. Absolute maximum ratings are stress ratings only and functional device operation is not implied.

■ THERMAL DATA

PARAMETER	SYMBOL	RATINGS	UNIT
Junction to Ambient	$\theta_{JA}$	625	$^\circ\text{C}/\text{W}$
Junction to Case	$\theta_{JC}$	215	$^\circ\text{C}/\text{W}$

■ ELECTRICAL CHARACTERISTICS ( $T_A=25^\circ\text{C}$ , unless otherwise specified)

PARAMETER	SYMBOL	TEST CONDITIONS	MIN	TYP	MAX	UNIT
<b>OFF CHARACTERISTICS</b>						
Drain-Source Breakdown Voltage	$BV_{DSS}$	$V_{GS}=0\text{V}, I_D=10\mu\text{A}$	60			V
Drain-Source Leakage Current	$I_{DSS}$	$V_{DS}=60\text{V}, V_{GS}=0\text{V}$			1	$\mu\text{A}$
Gate-Source Leakage Current	$I_{GSSF}$	$V_{GS}=20\text{V}, V_{DS}=0\text{V}$			100	nA
		$V_{GS}=-20\text{V}, V_{DS}=0\text{V}$			-100	nA
<b>ON CHARACTERISTICS (Note)</b>						
Gate Threshold Voltage	$V_{GS(TH)}$	$V_{GS}=V_{DS}, I_D=250\mu\text{A}$	1	2.1	2.5	V
Drain-Source On-Voltage	$V_{DS(ON)}$	$V_{GS}=10\text{V}, I_D=300\text{mA}$		0.6	3.75	V
		$V_{GS}=5.0\text{V}, I_D=50\text{mA}$			0.375	
Static Drain-Source On-Resistance	$R_{DS(ON)}$	$V_{GS}=10\text{V}, I_D=300\text{mA}$			7.5	$\Omega$
		$V_{GS}=5.0\text{V}, I_D=50\text{mA}$			7.5	$\Omega$
<b>DYNAMIC CHARACTERISTICS</b>						
Input Capacitance	$C_{ISS}$	$V_{DS}=25\text{V}, V_{GS}=0\text{V}, f=1.0\text{MHz}$		20	50	pF
Output Capacitance	$C_{OSS}$			11	25	pF
Reverse Transfer Capacitance	$C_{RSS}$			4	5	pF
Turn-On Time	$t_{ON}$	$V_{DD}=30\text{V}, R_L=150\Omega, I_D=200\text{mA}, V_{GS}=10\text{V}, R_{GEN}=25\Omega$			20	nS
Turn-Off Time	$t_{OFF}$	$V_{DD}=30\text{V}, R_L=25\Omega, I_D=200\text{mA}, V_{GS}=10\text{V}, R_{GEN}=25\Omega$			20	nS
<b>DRAIN-SOURCE DIODE CHARACTERISTICS AND MAXIMUM RATINGS</b>						
Drain-Source Diode Forward Voltage	$V_{SD}$	$V_{GS}=0\text{V}, I_S=300\text{mA}$ (Note)		0.88	1.5	V
Maximum Pulsed Drain-Source Diode Forward Current	$I_{SM}$				0.8	A
Maximum Continuous Drain-Source Diode Forward Current	$I_S$				300	mA

Note: Pulse Test: Pulse Width  $\leq 300\mu\text{s}$ , Duty Cycle  $\leq 2.0\%$

■ TEST CIRCUIT AND WAVEFORM

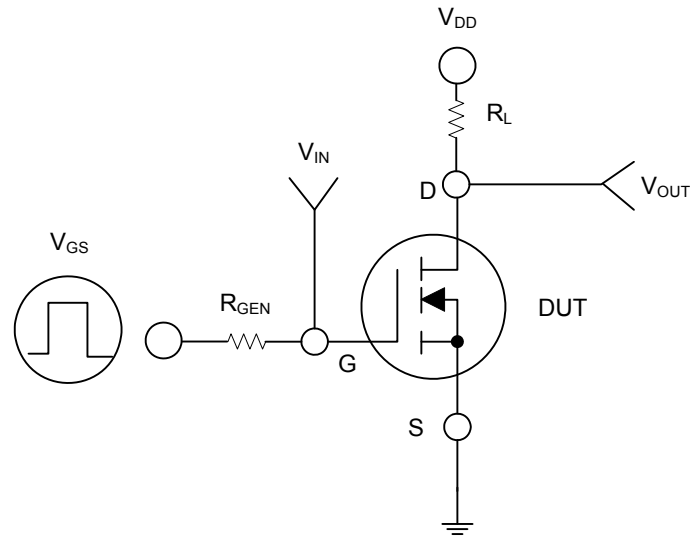

Fig. 1

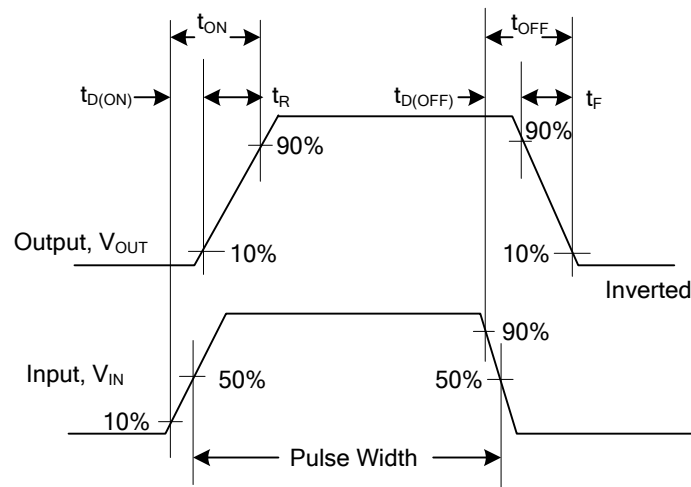
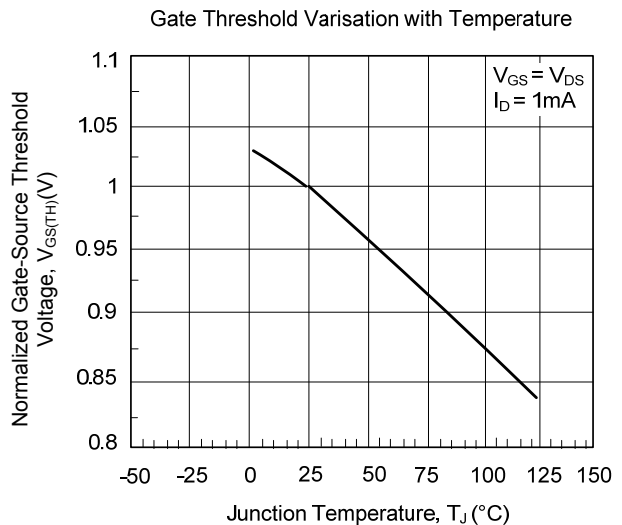
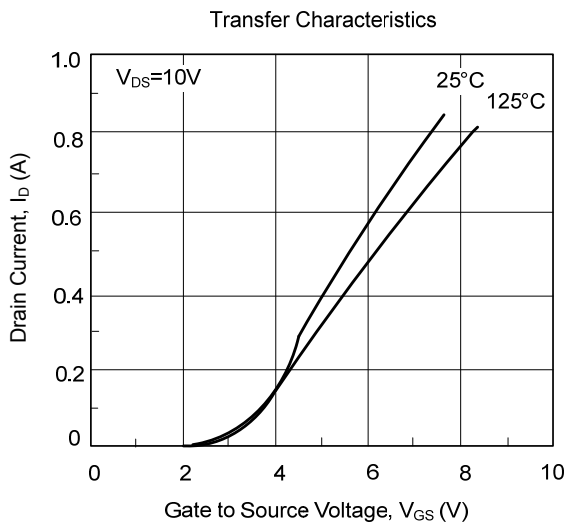
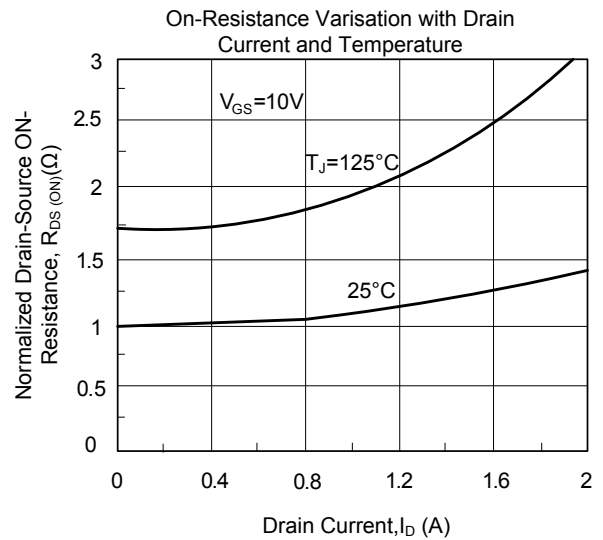
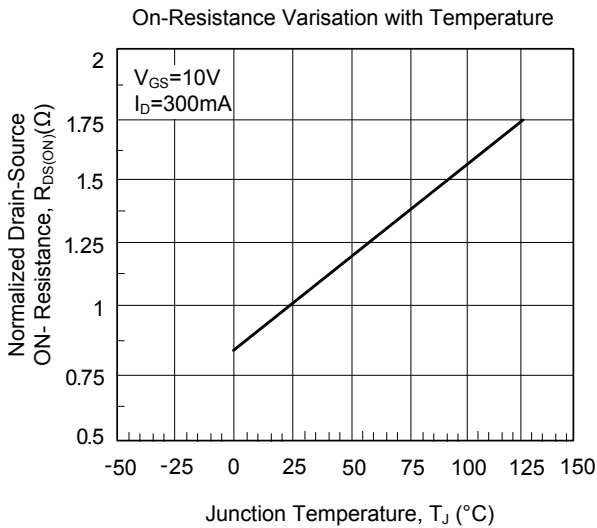
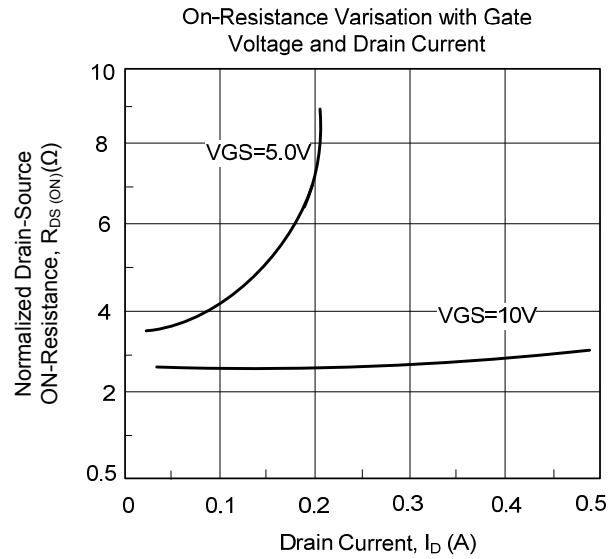
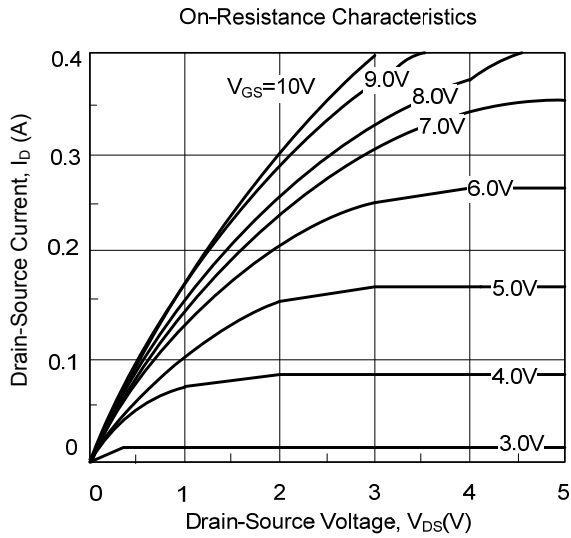

Fig. 2 Switching Waveforms

■ TYPICAL CHARACTERISTICS



■ TYPICAL CHARACTERISTICS (Cont.)

Breakdown Voltage Variation with Temperature

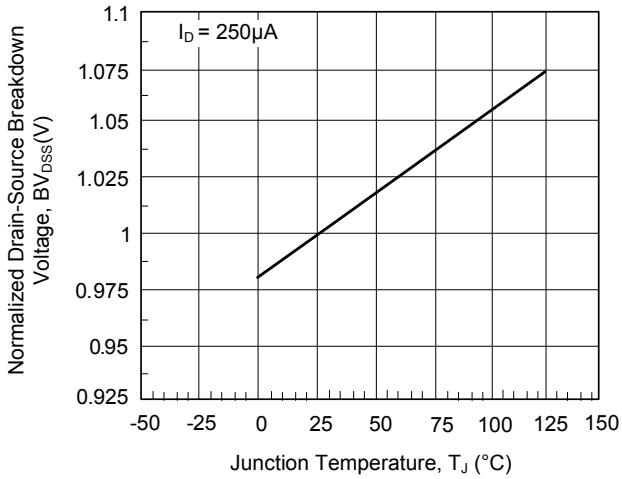

Body Diode Forward Voltage Variation with Temperature

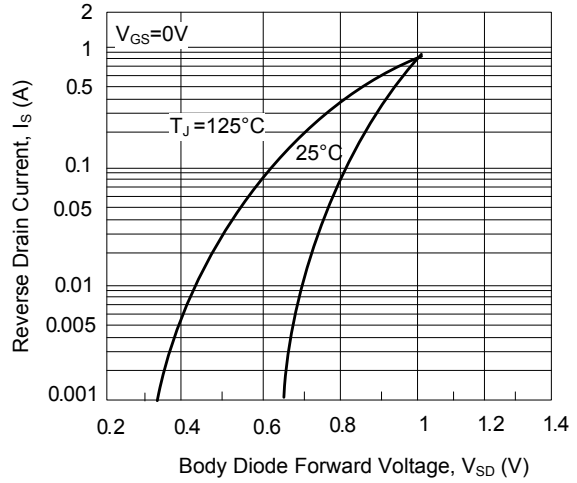

Capacitance Characteristics

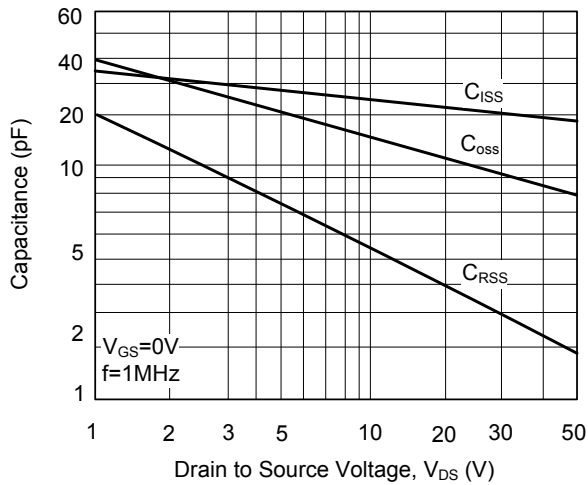

Gate Charge Characteristics

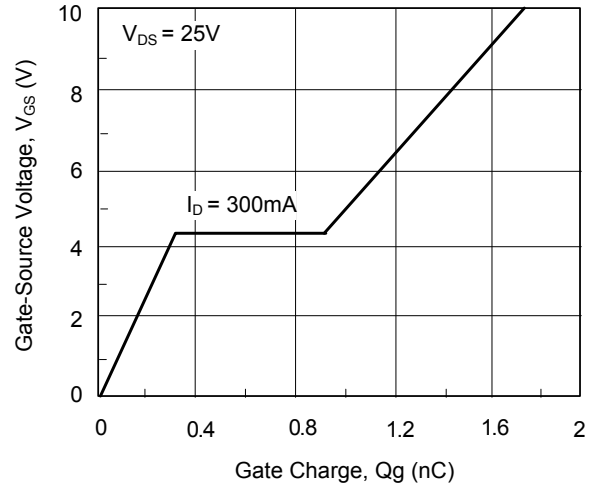

Maximum Safe Operating Area

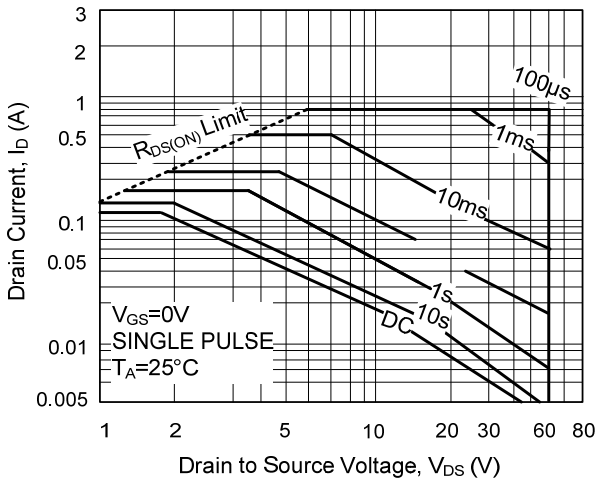

Transient Thermal Response Curve

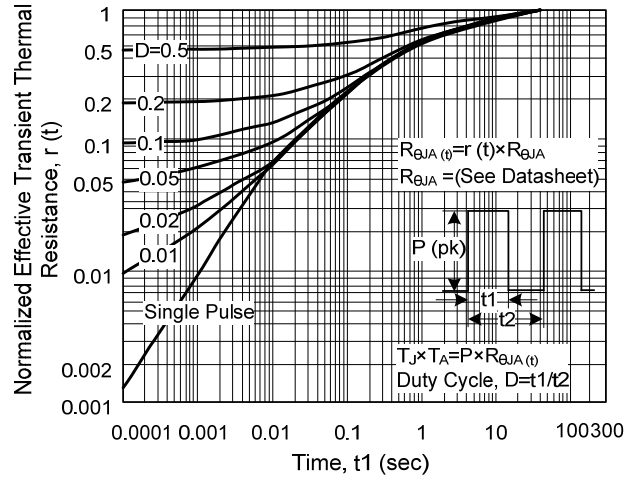

UTC assumes no responsibility for equipment failures that result from using products at values that exceed, even momentarily, rated values (such as maximum ratings, operating condition ranges, or other parameters) listed in products specifications of any and all UTC products described or contained herein. UTC products are not designed for use in life support appliances, devices or systems where malfunction of these products can be reasonably expected to result in personal injury. Reproduction in whole or in part is prohibited without the prior written consent of the copyright owner. The information presented in this document does not form part of any quotation or contract, is believed to be accurate and reliable and may be changed without notice.