

## Applications

- Military radar
- Civilian radar
- Professional and military radio communications
- Test instrumentation
- Wideband or narrowband amplifiers
- Jammers

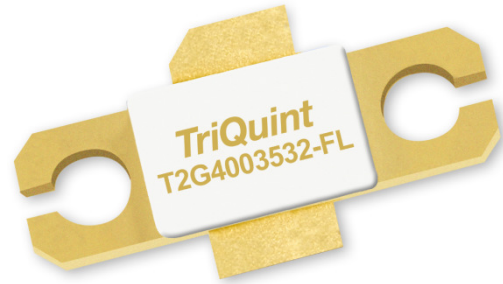

## Product Features

- Frequency: DC to 3.5 GHz
- Output Power ( $P_{3dB}$ ): 28 W at 3.5 GHz
- Linear Gain: >16 dB at 3.5 GHz
- Operating Voltage: 32 V
- Low thermal resistance package

## Functional Block Diagram

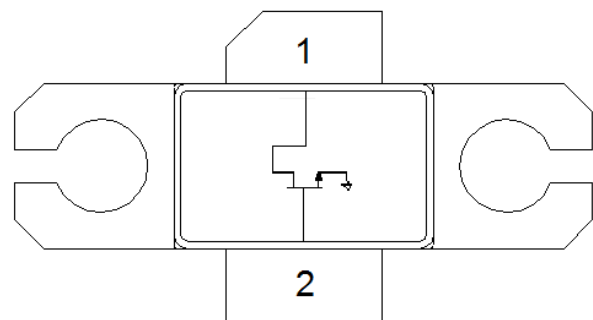

## General Description

The TriQuint T2G4003532-FL is a 30 W ( $P_{3dB}$ ) discrete GaN on SiC HEMT which operates from DC to 3.5 GHz. The device is constructed with TriQuint's proven TQGaN25 process, which features advanced field plate techniques to optimize power and efficiency at high drain bias operating conditions. This optimization can potentially lower system costs in terms of fewer amplifier line-ups and lower thermal management costs.

Lead-free and ROHS compliant

Evaluation boards are available upon request.

## Pin Configuration

Pin No.	Label
1	$V_D$ / RF OUT
2	$V_G$ / RF IN
Flange	Source

## Ordering Information

Part	ECCN	Description
T2G4003532-FL	EAR99	Packaged part Flangeless
T2G4003532- FS/FL-EVB1	EAR99	2.7-3.5 GHz Evaluation Board

### Absolute Maximum Ratings

Parameter	Value
Breakdown Voltage ( $V_{DG}$ )	100 V
Gate Voltage Range ( $V_G$ )	-7 to 0 V
Drain Current ( $I_D$ )	4.5 A
Gate Current ( $I_G$ )	-7.5 to 12 mA
Power Dissipation ( $P_D$ )	40 W
RF Input Power, CW, T = 25°C ( $P_{IN}$ )	38.75 dBm
Channel Temperature ( $T_{CH}$ )	275 °C
Mounting Temperature (30 Seconds)	320 °C
Storage Temperature	-40 to 150 °C

Operation of this device outside the parameter ranges given above may cause permanent damage. These are stress ratings only, and functional operation of the device at these conditions is not implied.

### Recommended Operating Conditions

Parameter	Value
Drain Voltage ( $V_D$ )	32 V (Typ.)
Drain Quiescent Current ( $I_{DQ}$ )	150 mA (Typ.)
Peak Drain Current ( $I_D$ )	1900 mA (Typ.)
Gate Voltage ( $V_G$ )	-2.9 V (Typ.)
Channel Temperature ( $T_{CH}$ )	225 °C (Max)
Power Dissipation, CW ( $P_D$ )	28 W (Max)
Power Dissipation, Pulse ( $P_D$ )	46 W (Max)

Electrical specifications are measured at specified test conditions. Specifications are not guaranteed over all recommended operating conditions.

### RF Characterization – Load Pull Performance at 1.0 GHz <sup>(1)</sup>

Test conditions unless otherwise noted:  $T_A = 25$  °C,  $V_D = 32$  V,  $I_{DQ} = 150$  mA

Symbol	Parameter	Min	Typical	Max	Units
$G_{LIN}$	Linear Gain		21.6		dB
$P_{3dB}$	Output Power at 3 dB Gain Compression		27.0		W
$DE_{3dB}$	Drain Efficiency at 3 dB Gain Compression		51.0		%
$PAE_{3dB}$	Power-Added Efficiency at 3 dB Gain		50.0		%
$G_{3dB}$	Gain at 3 dB Compression		18.6		dB

Notes:

- $V_{DS} = 32$  V,  $I_{DQ} = 150$  mA; Pulse: 100 $\mu$ s, 20%

### RF Characterization – Load Pull Performance at 3.5 GHz <sup>(1)</sup>

Test conditions unless otherwise noted:  $T_A = 25$  °C,  $V_D = 32$  V,  $I_{DQ} = 150$  mA

Symbol	Parameter	Min	Typical	Max	Units
$G_{LIN}$	Linear Gain		17.7		dB
$P_{3dB}$	Output Power at 3 dB Gain Compression		31.0		W
$DE_{3dB}$	Drain Efficiency at 3 dB Gain Compression		59.7		%
$PAE_{3dB}$	Power-Added Efficiency at 3 dB Gain		57.6		%
$G_{3dB}$	Gain at 3 dB Compression		14.7		dB

Notes:

- $V_{DS} = 32$  V,  $I_{DQ} = 150$  mA; Pulse: 100 $\mu$ s, 20%

### RF Characterization – Performance at 3.5 GHz <sup>(1, 2)</sup>

Test conditions unless otherwise noted:  $T_A = 25\text{ }^\circ\text{C}$ ,  $V_D = 32\text{ V}$ ,  $I_{DQ} = 150\text{ mA}$

Symbol	Parameter	Min	Typical	Max	Units
$G_{LIN}$	Linear Gain	16.0	16.5		dB
$P_{3dB}$	Output Power at 3 dB Gain Compression	25.0	28.0		W
$DE_{3dB}$	Drain Efficiency at 3 dB Gain Compression	45.5	48.8		%
$G_{3dB}$	Gain at 3 dB Compression	13.0	13.5		dB

Notes:

1. Performance at 3.5 GHz in the 2.7 to 3.5 GHz Evaluation Board
2.  $V_{DS} = 32\text{ V}$ ,  $I_{DQ} = 150\text{ mA}$ ; Pulse: 100 $\mu$ s, 20%

### RF Characterization – Narrow Band Performance at 3.50 GHz <sup>(1)</sup>

Test conditions unless otherwise noted:  $T_A = 25\text{ }^\circ\text{C}$ ,  $V_D = 32\text{ V}$ ,  $I_{DQ} = 150\text{ mA}$

Symbol	Parameter	Typical
VSWR	Impedance Mismatch Ruggedness	10:1

Notes:

1.  $V_{DS} = 32\text{ V}$ ,  $I_{DQ} = 150\text{ mA}$ , CW at  $P_{1dB}$

## Thermal and Reliability Information

Parameter	Test Conditions	Value	Units
Thermal Resistance ( $\theta_{JC}$ )	DC at 85 °C Case	4.9	°C/W
Channel Temperature ( $T_{CH}$ )		225	°C

Notes:

Thermal resistance measured to bottom of package, CW.

## Median Lifetime

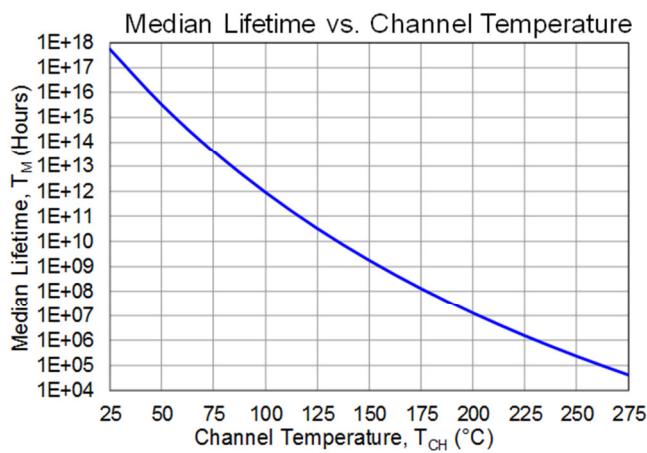

## Maximum Channel Temperature

$T_{BASE} = 85^\circ\text{C}$ ,  $P_D = 30\text{ W}$

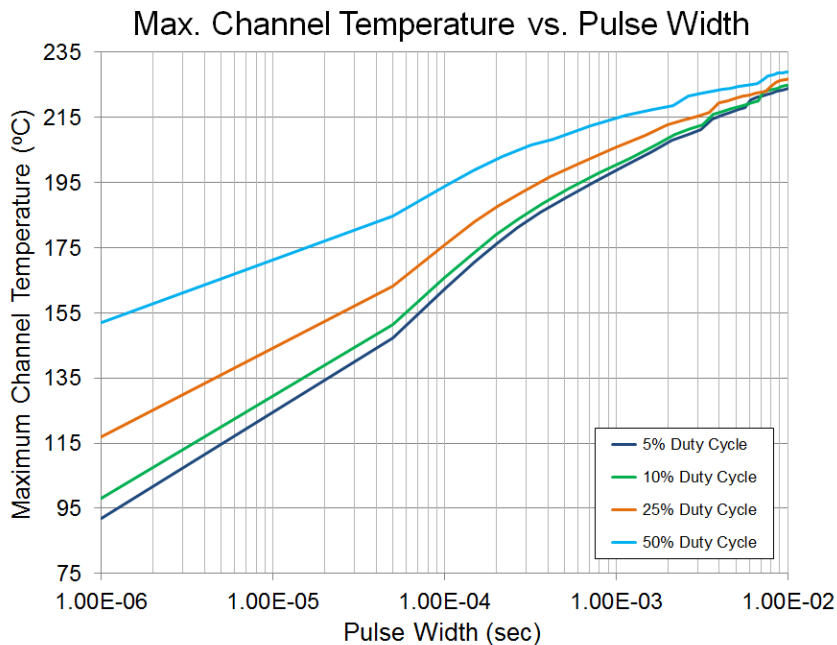

## Load Pull Smith Charts (1, 2)

RF performance that the device typically exhibits when placed in the specified impedance environment. The impedances are not the impedances of the device, they are the impedances presented to the device via an RF circuit or load-pull system. The impedances listed follow an optimized trajectory to maintain high power and high efficiency.

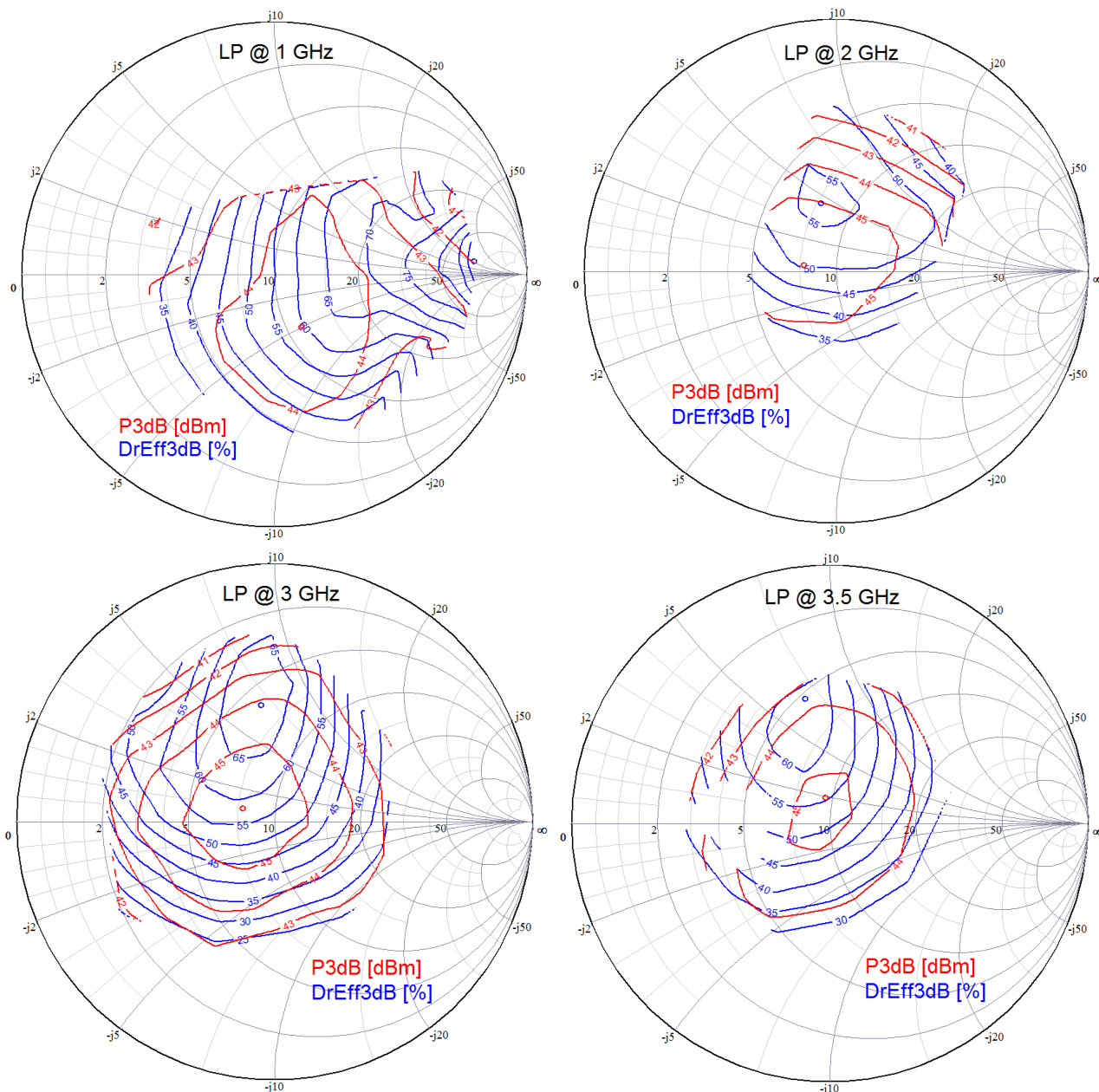

### Notes:

1. Test Conditions:  $V_{DS} = 32 \text{ V}$ ,  $I_{DQ} = 150 \text{ mA}$
2. Test Signal: Pulse Width = 100  $\mu\text{sec}$ , Duty Cycle = 20%

**Typical Performance**

Performance is based on compromised impedance point and measured at DUT reference plane.

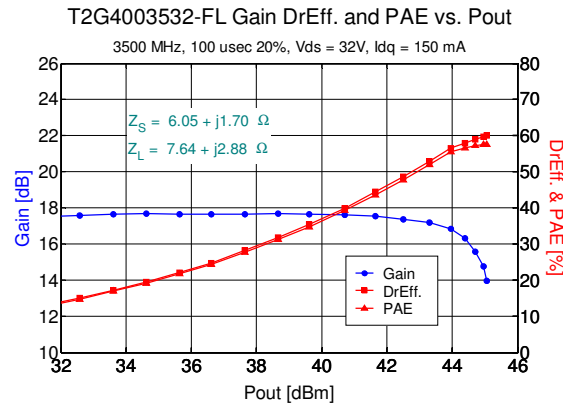
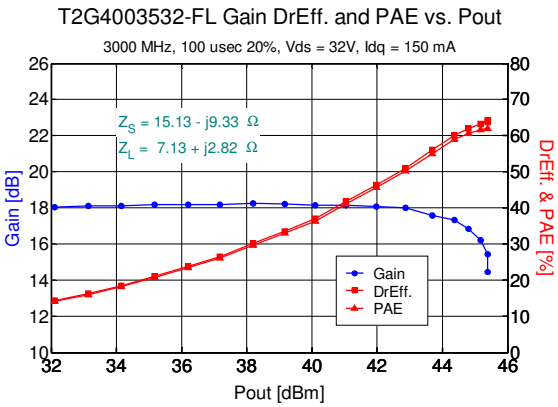
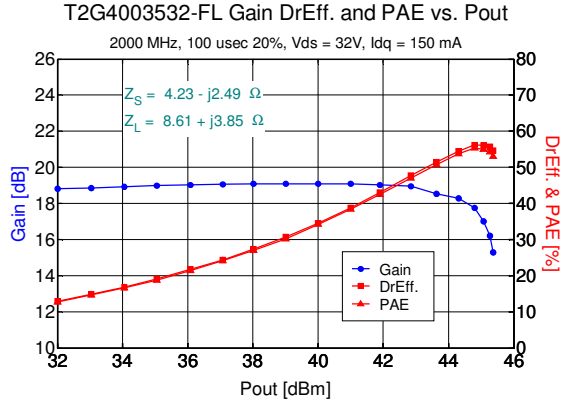
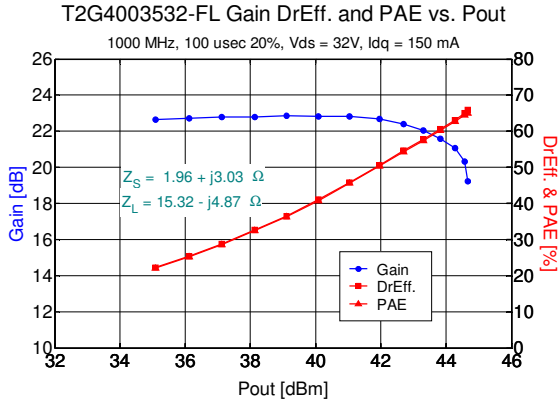

## Performance Over Temperature (1, 2)

Performance measured in TriQuint's 2.7 GHz to 3.5 GHz Evaluation Board at 3 dB compression.

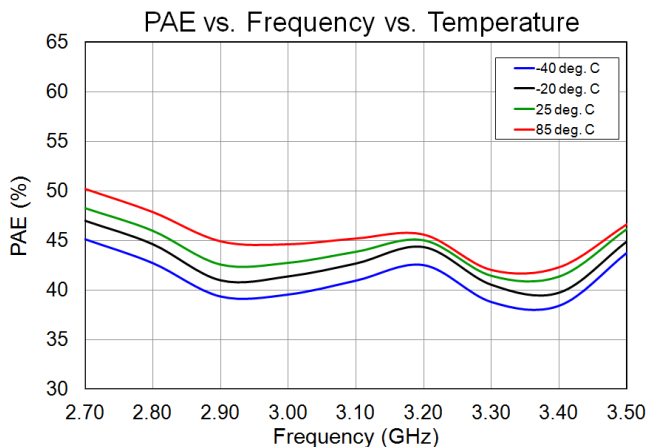
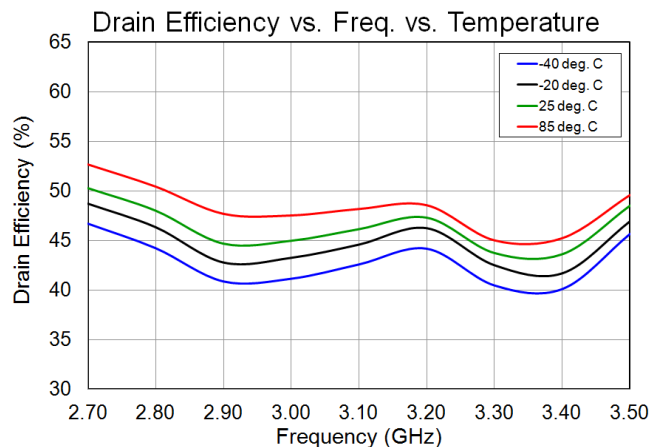
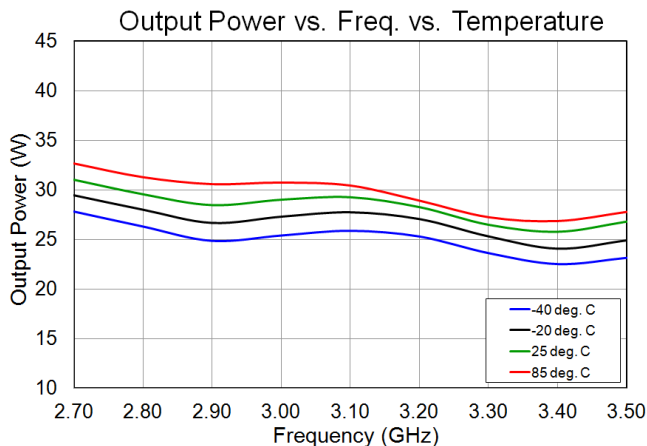
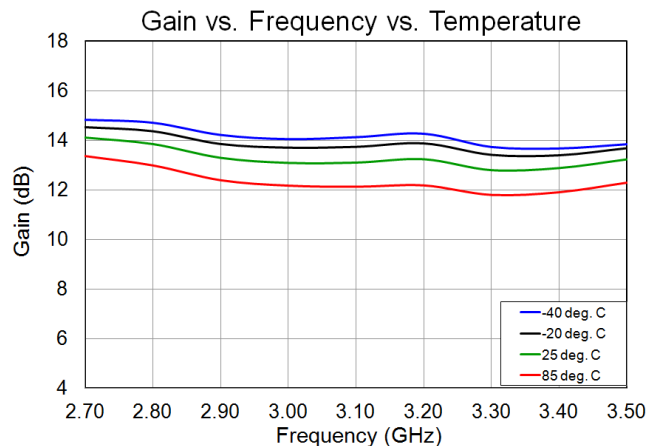

**Notes:**

1. Test Conditions:  $V_{DS} = 32\text{ V}$ ,  $I_{DQ} = 150\text{ mA}$
2. Test Signal: Pulse Width = 100  $\mu\text{s}$ , Duty Cycle = 20%

## Evaluation Board Performance <sup>(1, 2)</sup>

Performance at 3 dB Compression

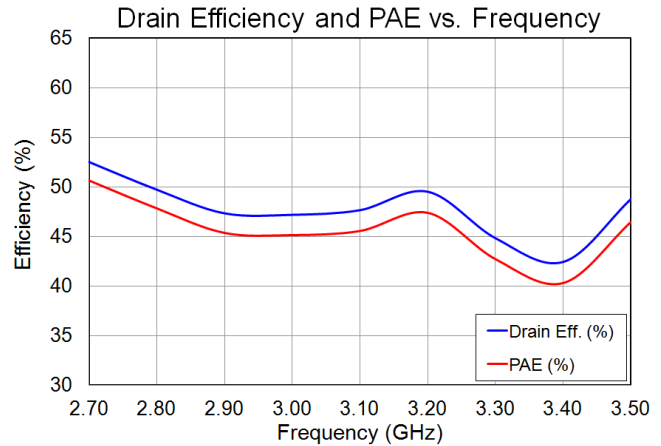
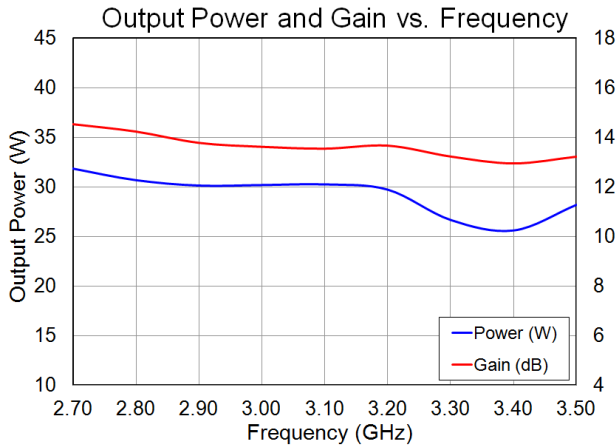

Notes:

1. Test Conditions:  $V_{DS} = 32\text{ V}$ ,  $I_{DQ} = 150\text{ mA}$
2. Test Signal: Pulse Width =  $100\text{ }\mu\text{s}$ , Duty Cycle = 20 %

## Application Circuit

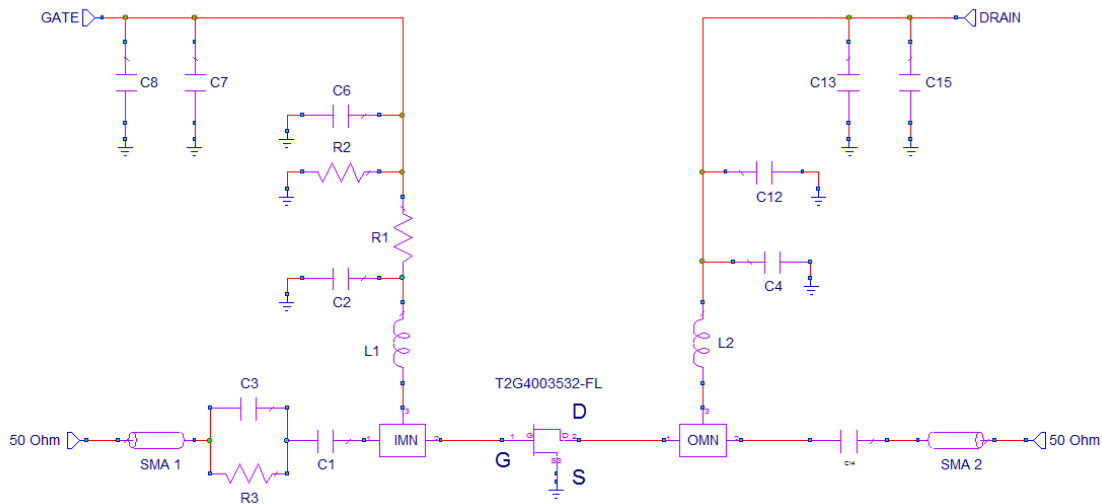

### Bias-up Procedure

- Set gate voltage ( $V_G$ ) to  $-5.0\text{ V}$
- Set drain voltage ( $V_D$ ) to  $32\text{ V}$
- Slowly increase  $V_G$  until quiescent  $I_D$  is  $150\text{ mA}$ .
- Apply RF signal

### Bias-down Procedure

- Turn off RF signal
- Turn off  $V_D$  and wait 1 second to allow drain capacitor dissipation
- Turn off  $V_G$



## Evaluation Board Layout

Top RF layer is 0.020" thick Rogers RO4350B,  $\epsilon_r = 3.48$ . The pad pattern shown has been developed and tested for optimized assembly at TriQuint Semiconductor. The PCB land pattern has been developed to accommodate lead and package tolerances.

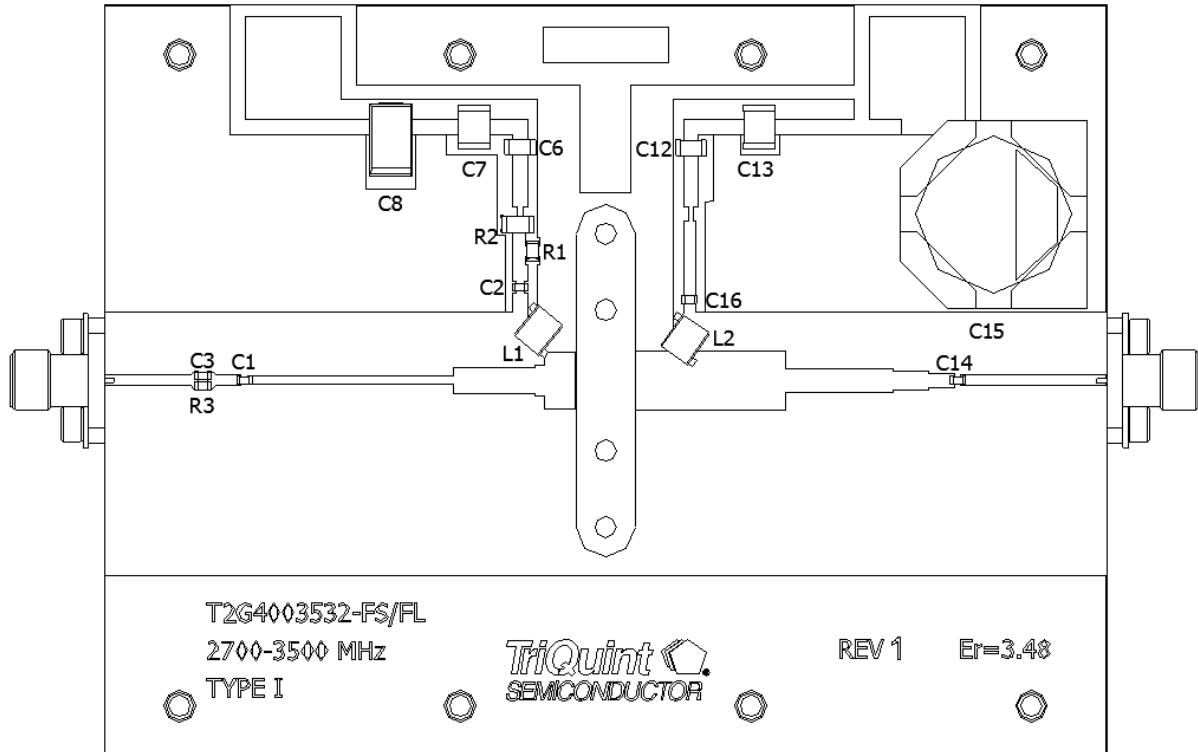

## Bill of Materials

Reference Des.	Value	Qty	Manufacturer	Part Number
C1, C2, C3, C14	10 pF	4	ATC	600S100FT250XT
C6, C12	0.1 uF	2	Kemet	C1206C104K1RACTU
C7, C13	1.0 uF	2	AVX	18121C105KAT2A
C8	22 uF	1	Vishay Sprague	293D226X9035E2TE3
C15	470 uF	1	Illinois Capacitor	477KXM035M
C16	2400 pF	1	Dielectric Labs	C08BL242X_5SN_X0T
L1, L2	8.0 nH	2	Coilcraft	A03TJLB
R1	12.1 Ohms	1	Vishay Dale	CRCW120612R1FKEA
R2	1000 Ohms	1	Vishay Dale	CRCW12061K00FKEA
R3	97.6 Ohms	1	Vishay Dale	CRCW060397R6FKEA

## Pin Layout

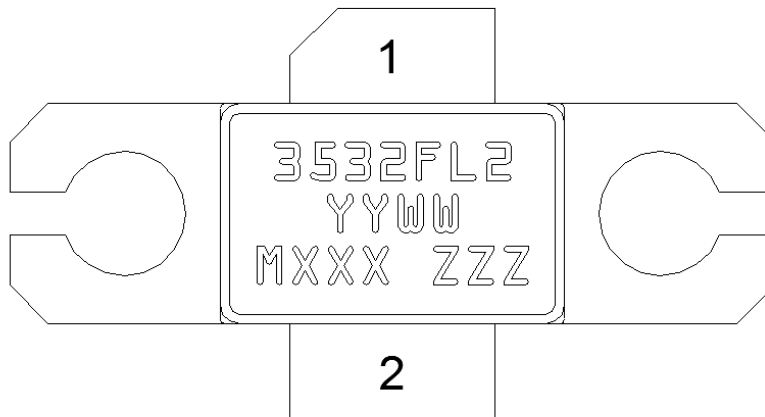

TOP VIEW

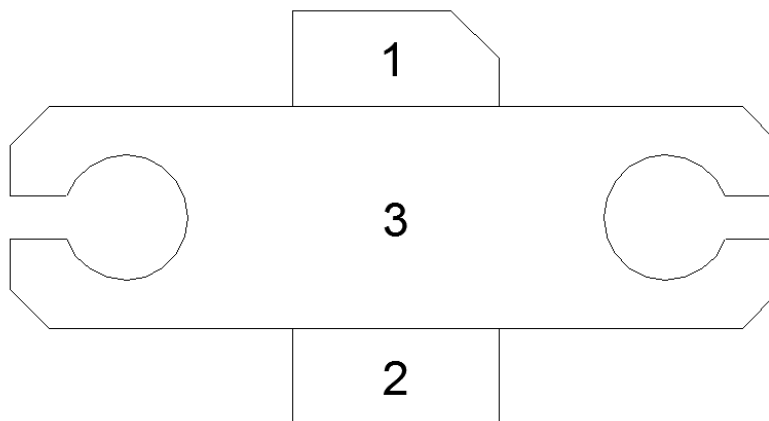

BOTTOM VIEW

Note:

The T2G4003532-FL will be marked with the “3532FS2” designator and a lot code marked below the part designator. The “YY” represents the last two digits of the calendar year the part was manufactured, the “WW” is the work week of the assembly lot start, the “MXXX” is the production lot number, and the “ZZZ” is an auto-generated serial number.

## Pin Description

Pin	Symbol	Description
1	$V_D$ / RF OUT	Drain voltage / RF Output matched to 50 ohms; see EVB Layout on page 9 as an example.
2	$V_G$ / RF IN	Gate voltage / RF Input matched to 50 ohms; see EVB Layout on page 9 as an example.
3	Flange	Source connected to ground; see EVB Layout on page 9 as an example.

**Mechanical Information**

All dimensions are in millimeters.

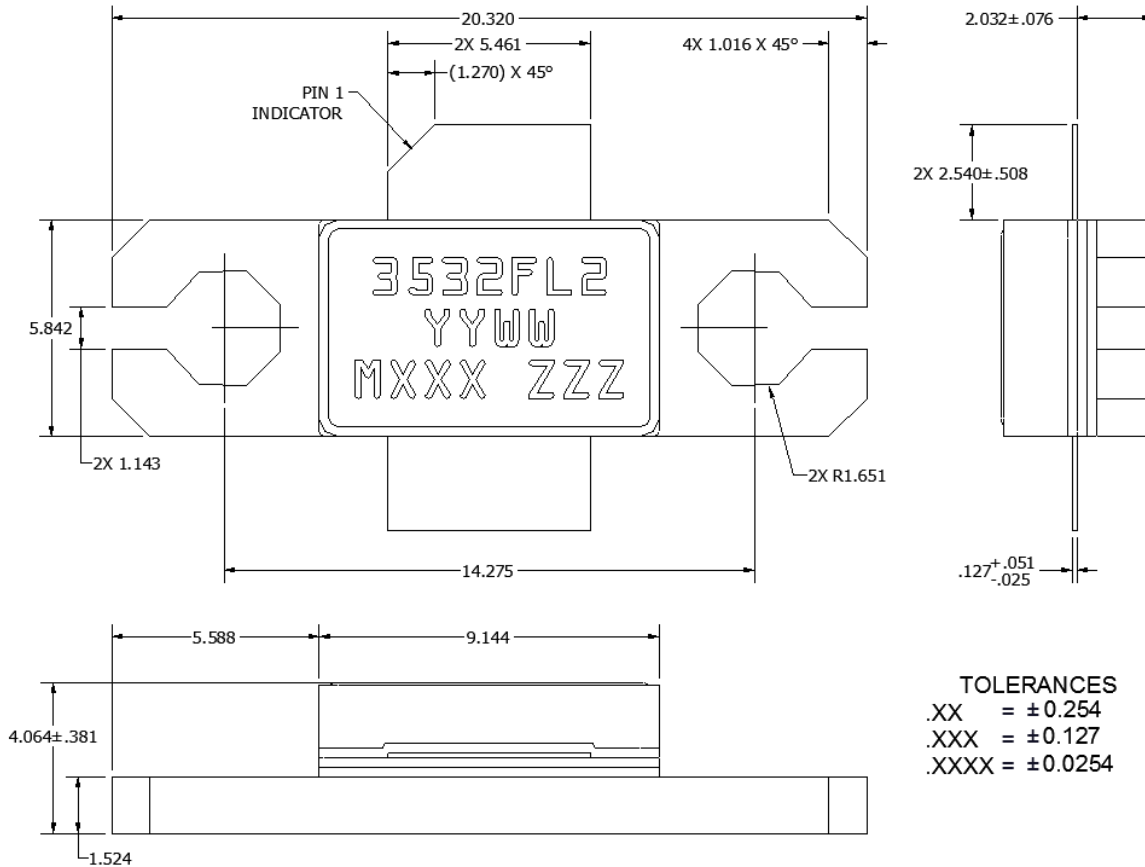

**Note:**

This package is lead-free/RoHS-compliant. The plating material on the leads is NiAu. It is compatible with both lead-free (maximum 260 °C reflow temperature) and tin-lead (maximum 245 °C reflow temperature) soldering processes.

## Product Compliance Information

### ESD Sensitivity Ratings



Caution! ESD-Sensitive Device

ESD Rating: Class 1B  
 Value: Passes  $\geq 500$  V to  $< 1000$  V max.  
 Test: Human Body Model (HBM)  
 Standard: JEDEC Standard JESD22-A114

### MSL Rating

Level 3 at  $+260$  °C convection reflow  
 The part is rated Moisture Sensitivity Level 3 at  $260$  °C per JEDEC standard IPC/JEDEC J-STD-020.

### ECCN

US Department of Commerce EAR99

### Solderability

Compatible with the latest version of J-STD-020, Lead free solder,  $260$  °C

### RoHS Compliance

This part is compliant with EU 2002/95/EC RoHS directive (Restrictions on the Use of Certain Hazardous Substances in Electrical and Electronic Equipment).

This product also has the following attributes:

- Lead Free
- Halogen Free (Chlorine, Bromine)
- Antimony Free
- TBBP-A ( $C_{15}H_{12}Br_4O_2$ ) Free
- PFOS Free
- SVHC Free

## Recommended Soldering Temperature Profile

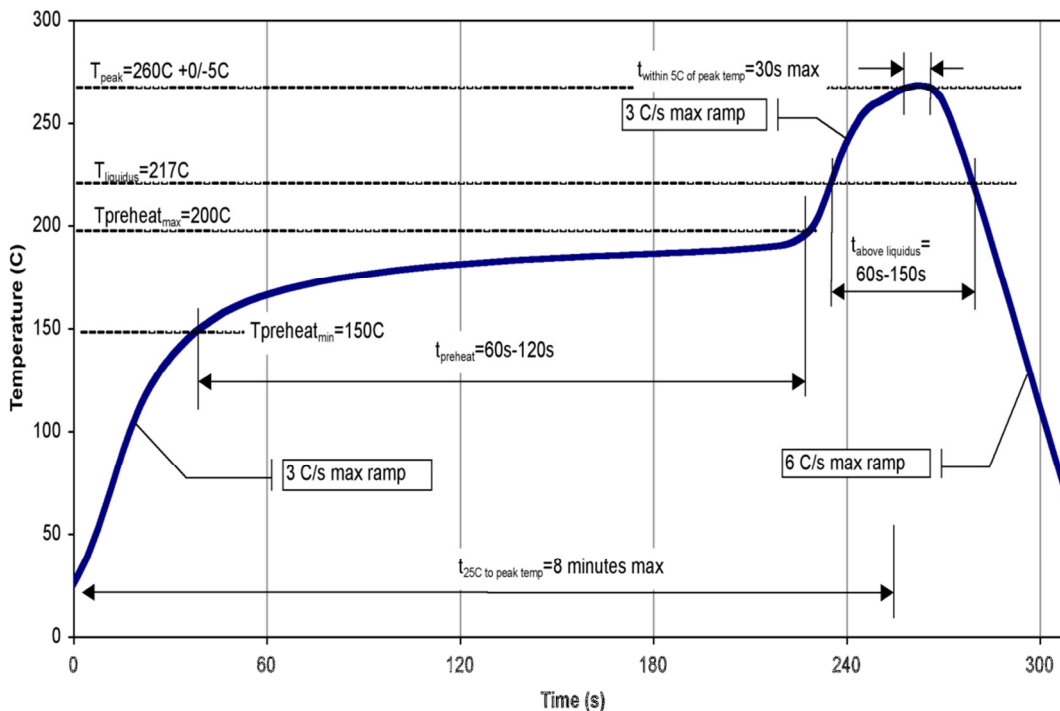

## Contact Information

For the latest specifications, additional product information, worldwide sales and distribution locations, and information about TriQuint:

**Web:** [www.triquint.com](http://www.triquint.com)

**Tel:** +1.972.994.8465

**Email:** [info-sales@triquint.com](mailto:info-sales@triquint.com)

**Fax:** +1.972.994.8504

For technical questions and application information:

**Email:** [info-products@triquint.com](mailto:info-products@triquint.com)

## Important Notice

The information contained herein is believed to be reliable. TriQuint makes no warranties regarding the information contained herein. TriQuint assumes no responsibility or liability whatsoever for any of the information contained herein. TriQuint assumes no responsibility or liability whatsoever for the use of the information contained herein. The information contained herein is provided "AS IS, WHERE IS" and with all faults, and the entire risk associated with such information is entirely with the user. All information contained herein is subject to change without notice. Customers should obtain and verify the latest relevant information before placing orders for TriQuint products. The information contained herein or any use of such information does not grant, explicitly or implicitly, to any party any patent rights, licenses, or any other intellectual property rights, whether with regard to such information itself or anything described by such information.

TriQuint products are not warranted or authorized for use as critical components in medical, life-saving, or life-sustaining applications, or other applications where a failure would reasonably be expected to cause severe personal injury or death.