

PLEASE CHECK WWW.MOLEX.COM FOR LATEST PART INFORMATION

Part Number: [0850520282](#)
Status: **Active**
Overview: [din_41612](#)
Description: 2.54mm (.100") Pitch DIN 41612 Receptacle, Style R Reverse, 96 Circuits

Documents:

[3D Model](#) [RoHS Certificate of Compliance \(PDF\)](#)
[Drawing \(PDF\)](#)

Agency Certification

CSA LR19980
 UL E29179

General

Product Family Backplane Connectors
 Series [85052](#)
 Application Backplane
 Component Type PCB Receptacle
 Overview [din_41612](#)
 Product Name IEC 603-2/DIN 41612
 Style R

Physical

Circuits (Loaded) 96
 Circuits (maximum) 96
 Durability (mating cycles max) 500
 First Mate / Last Break No
 Flammability 94V-0
 Guide to Mating Part No
 Keying to Mating Part Yes
 Number of Columns 32
 Number of Pairs Open Pin Field
 Number of Rows 3
 Orientation Right Angle
 PC Tail Length (in) 0.110 In
 PC Tail Length (mm) 2.80 mm
 PCB Locator No
 PCB Retention Yes
 PCB Thickness Recommended (in) 0.063 In, 0.126 In
 PCB Thickness Recommended (mm) 1.60 mm, 3.20 mm
 Packaging Type Tray
 Pitch - Mating Interface (in) 0.100 In
 Pitch - Mating Interface (mm) 2.54 mm
 Pitch - Term. Interface (in) 0.100 In
 Pitch - Term. Interface (mm) 2.54 mm
 Polarized to PCB Yes
 Stackable No
 Surface Mount Compatible (SMC) No
 Temperature Range - Operating -55°C to +125°C
 Termination Interface: Style Through Hole

Electrical

Current - Maximum per Contact 1A
 Data Rate 622.0 Mbps
 Real Signals (per 25mm) 30
 Voltage - Maximum 250V AC (RMS)

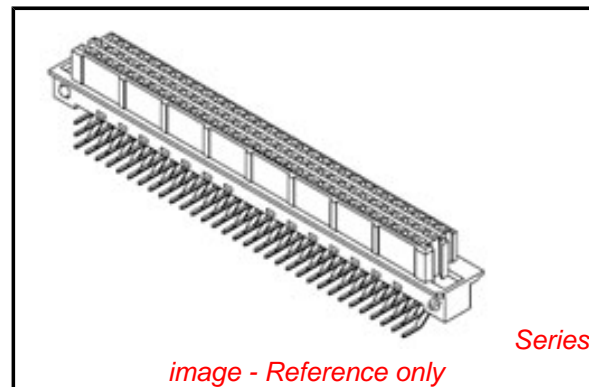

image - Reference only

EU RoHS

**ELV and RoHS
 Compliant**
REACH SVHC
 Not Reviewed
**Halogen-Free
 Status**
Not Reviewed

China RoHS



**Need more information on product
 environmental compliance?**

Email productcompliance@molex.com
 For a multiple part number RoHS Certificate of
 Compliance, [click here](#)

Please visit the [Contact Us](#) section for any
 non-product compliance questions.

Search Parts in this Series

[85052Series](#)

Mates With

DIN 41612 Headers [85003](#) , [85013](#)

Material Info

Reference - Drawing Numbers

Sales Drawing

SDA-85052-0001, SDA-85052-0282

This document was generated on 05/17/2010

PLEASE CHECK WWW.MOLEX.COM FOR LATEST PART INFORMATION

PART NO.
DWG. NO.

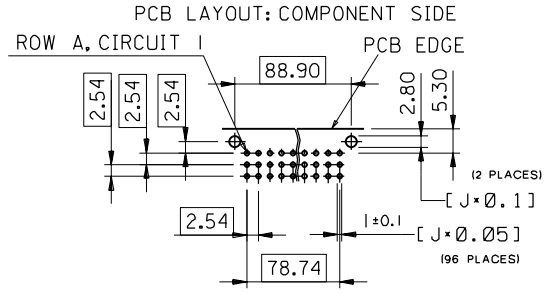
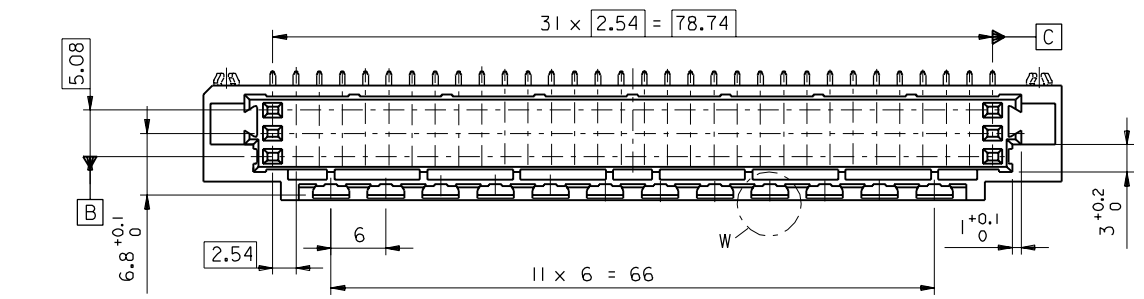
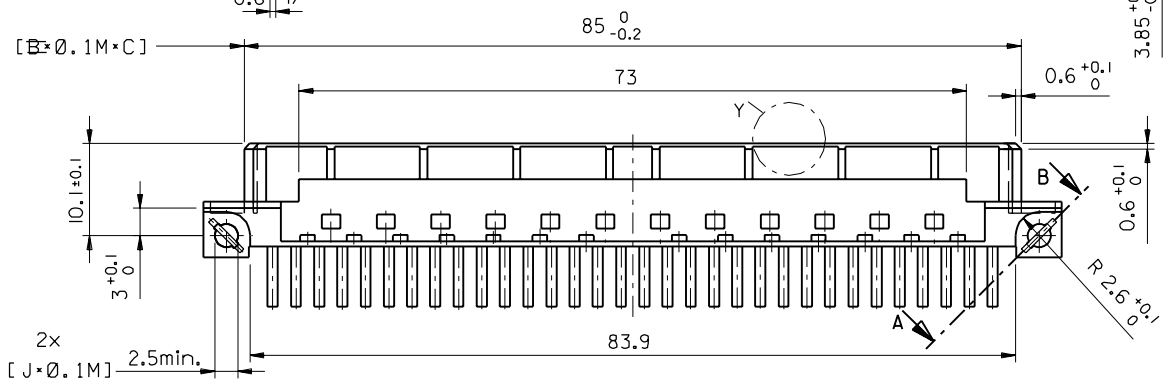
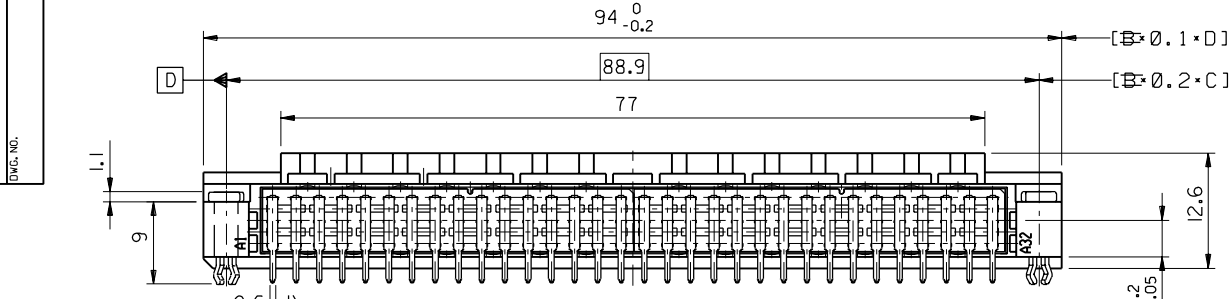

1) tails to fit in PC-board layout

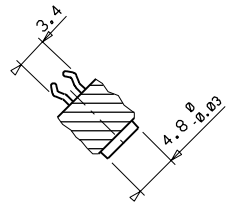
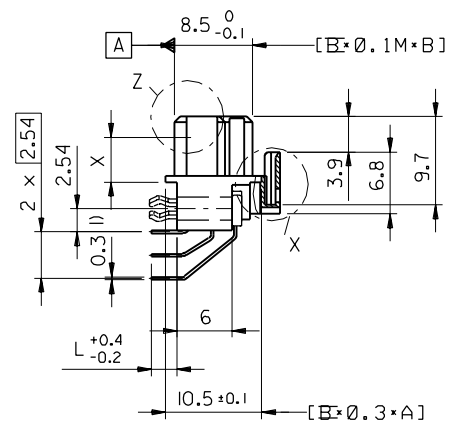

Section A - B

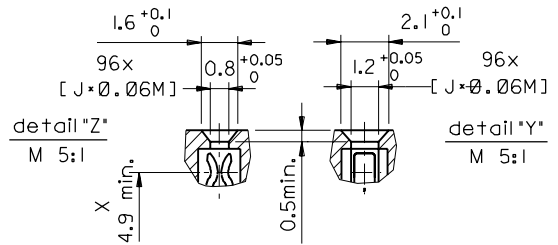
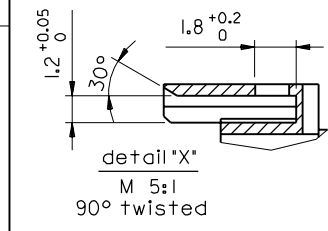
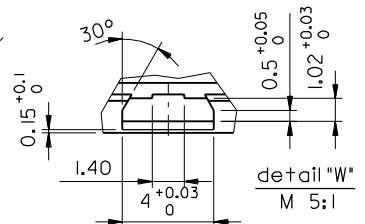

FIRST ANGLE PROJECTION

REVISE ONLY ON CAD SYSTEM

ECN MG1998-2586
hole pattern/L+0.4-0.2
97-09-15 KN

REVISIONS	INCH	METRIC
3 PLACE ±		
2 PLACE ±		
1 PLACE ±		
DRAFT WHERE APPLICABLE MUST REMAIN WITHIN DIMENSIONS		
DESIGN DIMENSION	<input checked="" type="checkbox"/> MM	<input type="checkbox"/> IN.
EQUIVALENT DIMENSION	<input type="checkbox"/> MM	<input type="checkbox"/> IN.
IF TWO DIMENSIONS ARE SHOWN THE UPPER IS THE DESIGN DIMENSION, LOWER IS SECONDARY		

DRWG BY: KN
CHK'D BY: Ca
APP'D BY: JB
SCALE: 2:1

CAD/CAM PROJECT NAME: 85052000 s12	THIS DRAWING CONTAINS INFORMATION THAT IS PROPRIETARY TO MOLEX INC. & SHOULD NOT BE USED WITHOUT WRITTEN PERMISSION	SH. REV.
TITLE: 96 pos. female connector DIN 41612 style Q,+ clip with coding, dimensions		
MOLEX MOLEX EUROPE		SHEET NO. DATE: 2 of 2 96/04/30
PART NO.	DWG NO. SDA-85052-0001	SIZE: B

