

BT151

SCR

SCRS

DESCRIPTION

Passivated thyristors in a plastic envelope, intended for use in applications requiring high bidirectional blocking voltage capability and high thermal cycling performance. Typical applications include motor control, industrial and domestic lighting, heating and static switching.

SYMBOL

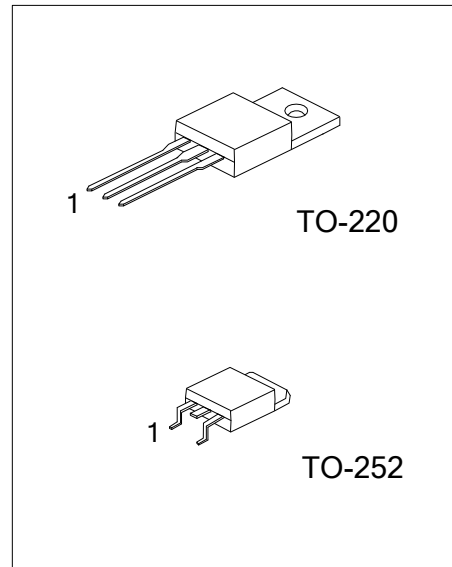
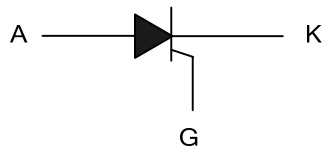

ORDERING INFORMATION

Order Number		Package	Pin Assignment			Packing
Lead Free	Halogen Free		1	2	3	
BT151L-5-TA3-T	BT151G-5-TA3-T	TO-220	K	A	G	Tube
BT151L-5-TN3-R	BT151G-5-TN3-R	TO-252	K	A	G	Tape Reel
BT151L-6-TA3-T	BT151G-6-TA3-T	TO-220	K	A	G	Tube
BT151L-6-TN3-R	BT151G-6-TN3-R	TO-252	K	A	G	Tape Reel
BT151L-8-TA3-T	BT151G-8-TA3-T	TO-220	K	A	G	Tube
BT151L-8-TN3-R	BT151G-8-TN3-R	TO-252	K	A	G	Tape Reel

Note: Pin assignment: K: CATHODE A: ANODE G: GATE

<p>BT151L-5-TA3-R</p> <p>(1) Packing Type</p> <p>(2) Package Type</p> <p>(3) Lead Free</p>	<p>(1) R: Tape Reel, T: Tube</p> <p>(2) TA3: TO-220, TN3: TO-252</p> <p>(3) G: Halogen Free, L: Lead Free</p>
--	---

■ ABSOLUTE MAXIMUM RATING

PARAMETER		SYMBOL	RATINGS	UNIT
Repetitive Peak Off-State Voltages	BT151-5	V_{DRM}, V_{RRM}	500 (Note 1)	V
	BT151-6		650 (Note 1)	
	BT151-8		800	
Average On-State Current (half sine wave; $T_{mb} \leq 109^\circ\text{C}$)		$I_{T(AV)}$	7.5	A
RMS on-State Current (all conduction angles)		$I_{T(RMS)}$	12	A
Non-Repetitive Peak On-State Current (half sine wave; $T_J = 25^\circ\text{C}$ prior to surge)	t = 10 ms	I_{TSM}	100	A
	t = 8.3 ms		110	
I^2t for Fusing (t = 10 ms)		I^2t	50	A^2s
Repetitive Rate of Rise of On-State Current After Triggering ($I_{TM} = 20\text{ A}$; $I_G = 50\text{ mA}$; $dI_G/dt = 50\text{ mA}/\mu\text{s}$)		dI_T/dt	50	$\text{A}/\mu\text{s}$
Peak Gate Current		I_{GM}	2	A
Peak Gate Voltage		V_{GM}	5	V
Peak Reverse Gate Voltage		V_{RGM}	5	V
Peak Gate Power		P_{GM}	5	W
Average Gate Power (Over any 20 ms period)		$P_{G(AV)}$	0.5	W
Storage Temperature		T_{stg}	-40 ~ 150	$^\circ\text{C}$
Operating Junction Temperature		T_J	125	$^\circ\text{C}$

Note: 1. Although not recommended, off-state voltages up to 800V may be applied without damage, but the thyristor may switch to the on-state. The rate of rise of current should not exceed $15\text{ A}/\mu\text{s}$.

2. Absolute maximum ratings are those values beyond which the device could be permanently damaged. Absolute maximum ratings are stress ratings only and functional device operation is not implied.

■ THERMAL DATA

PARAMETER	SYMBOL	RATINGS	UNIT
Junction to Mounting Base	θ_{JMb}	1.3	K/W
Junction to Ambient	θ_{JA}	60	K/W

■ STATIC CHARACTERISTICS ($T_J=25^\circ\text{C}$, unless otherwise stated)

PARAMETER	SYMBOL	CONDITIONS	MIN	TYP	MAX	UNIT
Gate Trigger Current	I_{GT}	$V_D = 12\text{ V}$, $I_T = 0.1\text{ A}$		2	15	mA
Latching Current	I_L	$V_D = 12\text{ V}$, $I_{GT} = 0.1\text{ A}$		10	40	mA
Holding Current	I_H	$V_D = 12\text{ V}$, $I_{GT} = 0.1\text{ A}$		7	20	mA
On-State Voltage	V_T	$I_T = 23\text{ A}$		1.4	1.75	V
Gate Trigger Voltage	V_{GT}	$V_D = 12\text{ V}$, $I_T = 0.1\text{ A}$		0.6	1.5	V
		$V_D = V_{DRM(max)}$, $I_T = 0.1\text{ A}$, $T_J = 125^\circ\text{C}$	0.25	0.4		
Off-State Leakage Current	I_D, I_R	$V_D = V_{DRM(max)}$, $V_R = V_{RRM(max)}$, $T_J = 125^\circ\text{C}$		0.1	0.5	mA

■ DYNAMIC CHARACTERISTICS ($T_J=25^\circ\text{C}$, unless otherwise stated)

PARAMETER	SYMBOL	CONDITIONS	MIN	TYP	MAX	UNIT
Critical Rate of Rise of Off-State Voltage	dV_D/dt	$V_{DM} = 67\% V_{DRM(max)}$, $T_J = 125^\circ\text{C}$, exponential waveform;	Gate open circuit	50	130	V/ μs
			$R_{GK} = 100\Omega$	200	1000	
Gate Controlled Turn-on Time	t_{GT}	$I_{TM} = 40\text{ A}$, $V_D = V_{DRM(max)}$, $I_G = 0.1\text{ A}$, $dI_G/dt = 5\text{ A}/\mu\text{s}$		2		μs
Circuit Commutated Turn-off time	t_Q	$V_D = 67\% V_{DRM(max)}$, $T_J = 125^\circ\text{C}$; $I_{TM} = 20\text{ A}$, $V_R = 25\text{ V}$, $dI_{TM}/dt = 30\text{ A}/\mu\text{s}$, $dV_D/dt = 50\text{ V}/\mu\text{s}$, $R_{GK} = 100\Omega$		70		μs

■ TYPICAL CHARACTERISTICS

Fig 1. Maximum On-State Dissipation, P_{tot} , Versus Average On-State Current, $I_{T(AV)}$, Where a =form factor= $I_{T(RMS)}/I_{T(AV)}$

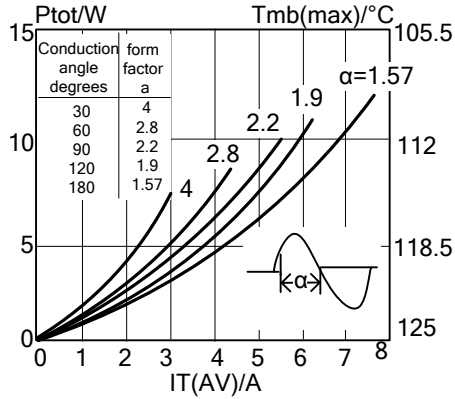

Fig 2. Maximum Permissible Non-Repetitive Peak On-State Current I_{TSM} , Versus Pulse Width t_p for Sinusoidal Currents, $t_p \leq 10ms$

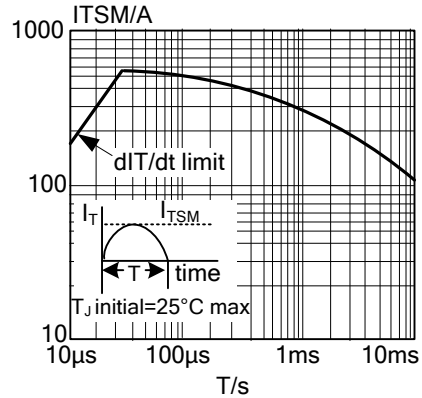

Fig 3. Maximum Permissible Rms Current $I_{T(RMS)}$, Versus Mounting Base Temperature T_{mb}

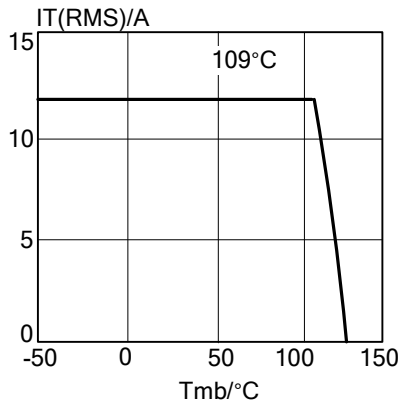

Fig 4. Maximum Permissible Non-Repetitive Peak On-State Current I_{TSM} , Versus Number Of Cycles, For Sinusoidal Currents, $f=50HZ$

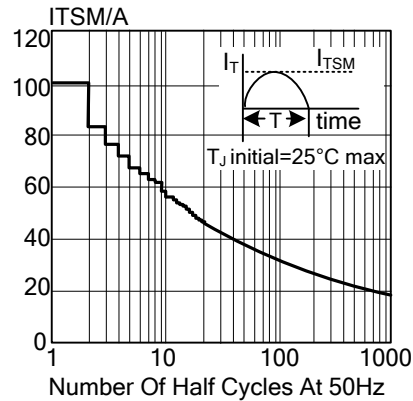

Fig 5. Maximum Permissible Repetitive Rms On-State Current $I_{T(RMS)}$, Versus Surge Duration, For Sinusoidal Currents, $f=50HZ$; $T_{mb} \leq 109^\circ C$

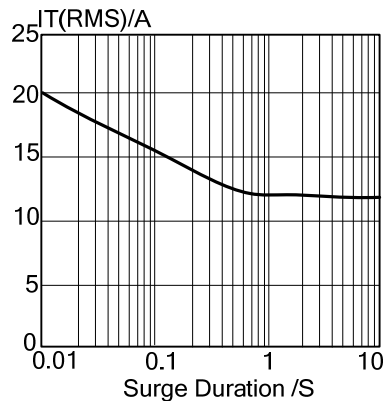
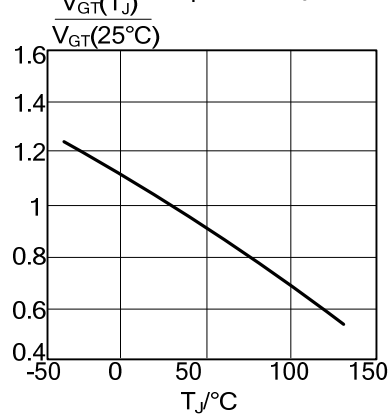

Fig 6. Normalised Gate Trigger Voltage $V_{GT}(T_J)/V_{GT}(25^\circ C)$, Versus Junction Temperature T_J



■ TYPICAL CHARACTERISTICS (Cont.)

Fig 7. Normalised Gate Trigger Current $I_{GT}(T_J)/I_{GT}(25^\circ\text{C})$, Versus Junction Temperature T_J

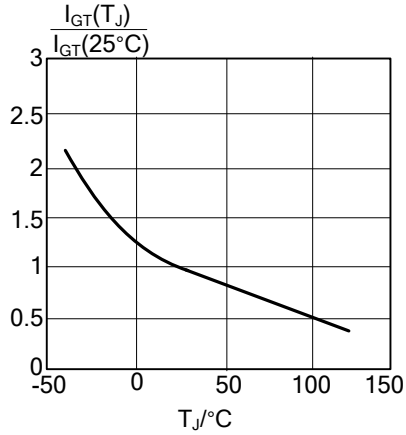

Fig 8. Normalised Latching Current $I_L(T_J)/I_L(25^\circ\text{C})$, Versus Junction Temperature T_J

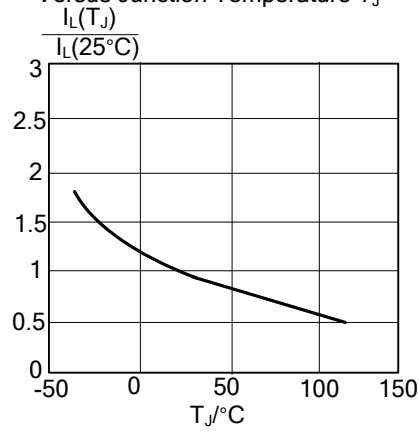

Fig 9. Normalised Holding Current $I_H(T_J)/I_H(25^\circ\text{C})$, Versus Junction Temperature T_J

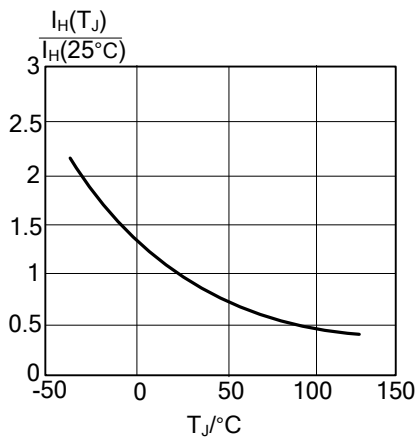

Fig 10. Typical and Maximum On-State Characteristic

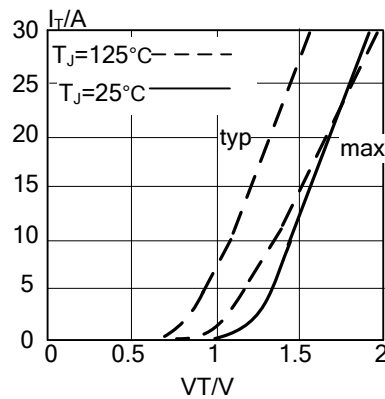

Fig 11. Transient Thermal Impedance Z_{thj-mb} , Versus Pulse Width t_p

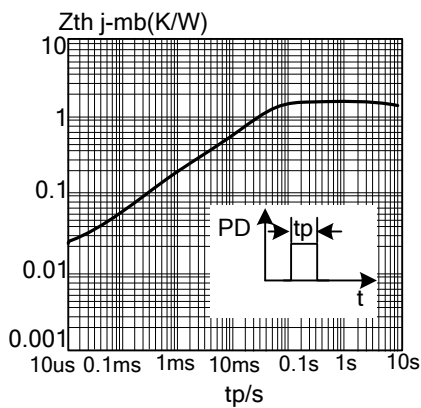
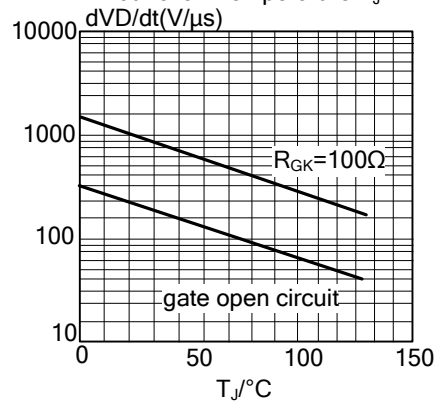

Fig 12. Typical, Critical Rate Of Rise Of Off-State Voltage, dV_D/dt Versus Junction Temperature T_J



UTC assumes no responsibility for equipment failures that result from using products at values that exceed, even momentarily, rated values (such as maximum ratings, operating condition ranges, or other parameters) listed in products specifications of any and all UTC products described or contained herein. UTC products are not designed for use in life support appliances, devices or systems where malfunction of these products can be reasonably expected to result in personal injury. Reproduction in whole or in part is prohibited without the prior written consent of the copyright owner. The information presented in this document does not form part of any quotation or contract, is believed to be accurate and reliable and may be changed without notice.