

3 Volt Voltage Variable Absorptive Attenuator
40 dB, 0.5-2.0 GHz

AT-113
V5

Features

- Single Positive Voltage Control: 0 to +3 Volts
- 40 dB Attenuation Range at 0.9 GHz
- ± 2 dB Linearity from BSL
- Low DC Power Consumption
- SOIC-8 Plastic Package
- Tape and Reel Packaging Available

Description

M/A-COM's AT-113 is a GaAs MMIC voltage variable absorptive attenuator in a low-cost SOIC 8-lead surface mount plastic package. The AT-113 is ideally suited for use where linear attenuation fine tuning and very low power consumption are required.

Typical applications include radio, cellular, GPS equipment and automatic gain/level control circuits.

The AT-113 is fabricated with a monolithic GaAs MMIC using a mature 1-micron process. The process features full chip passivation for increased performance and reliability.

Functional Schematic ^{1,2,3,4}

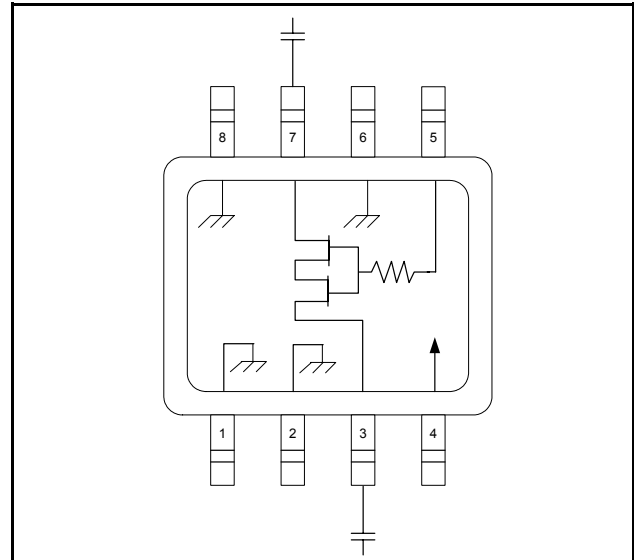

1. $V_{CC} = +3 \text{ VDC} @ 50 \mu\text{A}$ maximum.
2. $V_C = 0 \text{ VDC}$ to $+3 \text{ VDC} @ 50 \mu\text{A}$ maximum.
3. External DC blocking capacitors are required on all RF ports.
4. 39 pF used for data measurements.

Ordering Information

Part Number	Package
AT-113	SOIC 8-Lead Plastic Package
AT-113TR	Forward Tape and Reel

Note: Reference Application Note M513 for reel size information.

Pin Configuration

Pin No.	Function	Pin No.	Function
1	Ground	5	V_C
2	Ground	6	Ground
3	RF Port	7	RF Port
4	V_{CC}	8	Ground

Absolute Maximum Ratings ⁵

Parameter	Absolute Maximum
Input Power	+21 dBm
Supply Voltage V_{CC}	$-1 \text{ V} \leq V_{CC} \leq +8 \text{ V}$
Control Voltage V_C	$-1 \text{ V} \leq V_C \leq V_{CC} + 0.5 \text{ V}$
Operating Temperature	-40°C to $+85^\circ\text{C}$
Storage Temperature	-65°C to $+150^\circ\text{C}$

5. Exceeding any one or combination of these limits may cause permanent damage to this device.

**3 Volt Voltage Variable Absorptive Attenuator
40 dB, 0.5-2.0 GHz**

**AT-113
V5**

Electrical Specifications⁶: T_A = 25°C, Z₀ = 50 Ω

Parameter	Test Conditions	Units	Min	Typ	Max
Insertion Loss	0.5 - 1.0 GHz	dB	—	2.7	3.0
	1.0 - 2.0 GHz	dB	—	3.0	3.5
Attenuation	0.5 - 1.0 GHz	dB	40	—	—
	1.0 - 2.0 GHz	dB	35	—	—
Flatness (Peak to Peak)	0.5 - 1.0 GHz	dB	—	± 0.5	± 0.8
	1.0 - 2.0 GHz	dB	—	± 1.2	± 1.5
VSWR	—	Ratio	—	2:1	—
Trise, Tfall	10% to 90% RF, 90% to 10% RF	μS	—	10	—
Ton, Toff	50% Control to 90% RF, 50% Control to 10% RF	μS	—	12	—
Transients	In-band	mV	—	10	—

6. The RF ports must be blocked outside of the package from ground or any other voltage.

SOIC-8

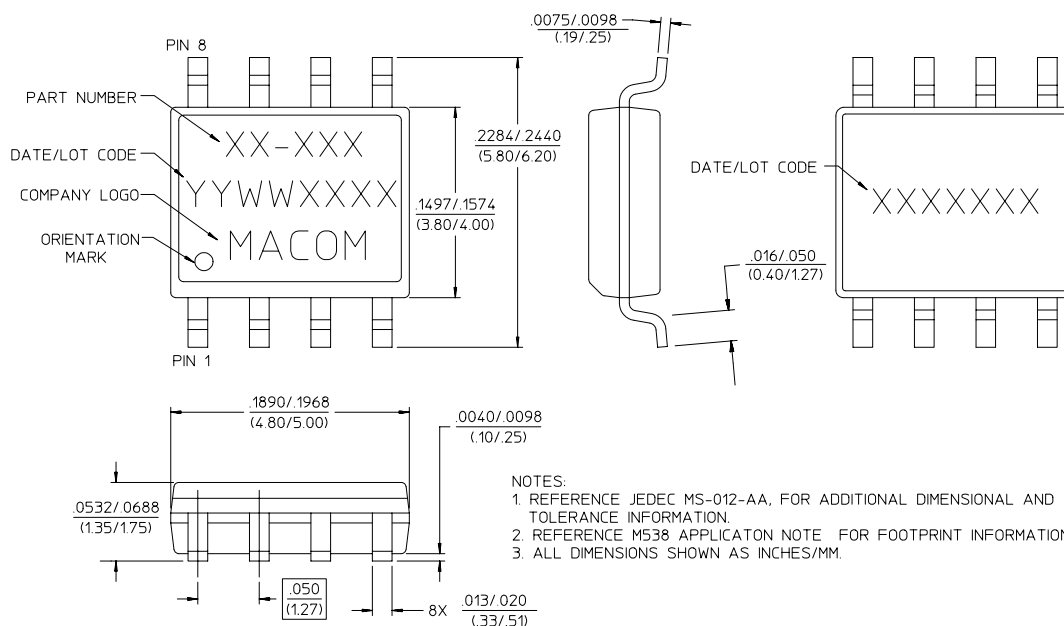

**3 Volt Voltage Variable Absorptive Attenuator
40 dB, 0.5-2.0 GHz**

**AT-113
V5**

Typical Performance Curves @ 25°C

Attenuation vs. Control Voltage

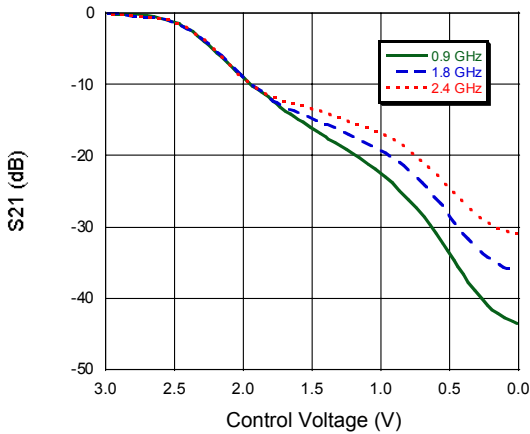

Attenuation vs. Frequency @ 0V

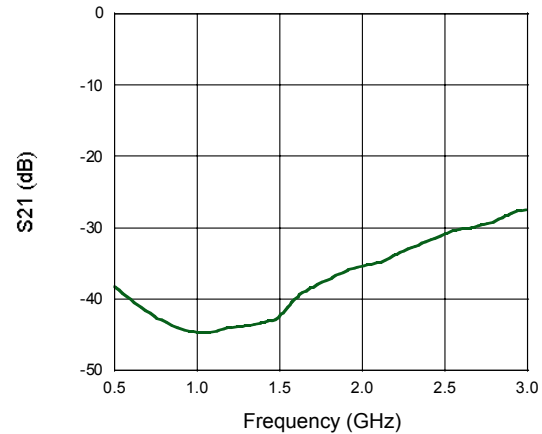

Insertion Loss vs. Frequency

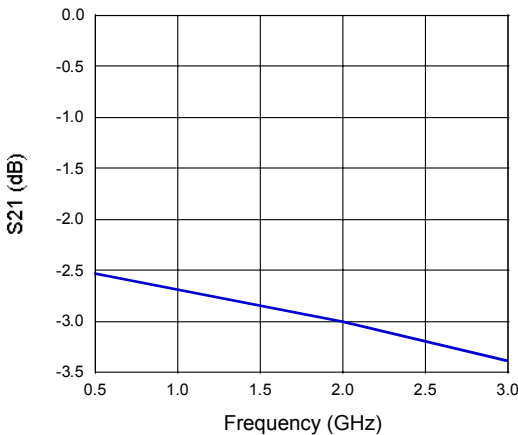

**Return Loss vs. Control Voltage
F = 900 MHz**

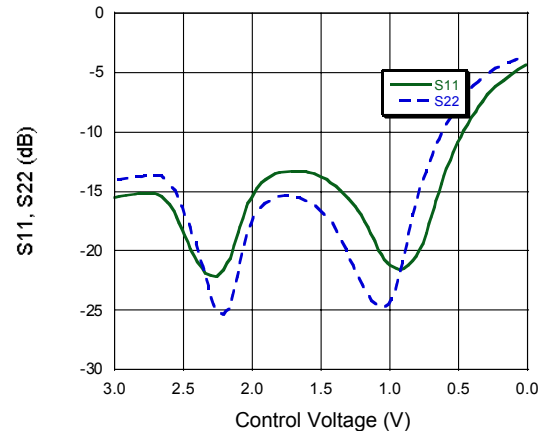

1 dB Compression vs. Control Voltage

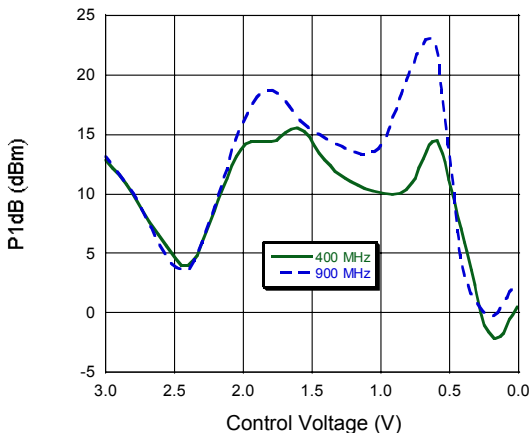

IP3 vs. Control Voltage

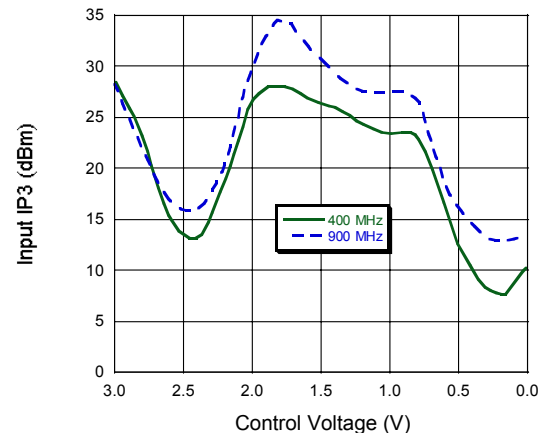

Typical Performance Curves

Attenuation vs. Temperature
Normalized @ 25°C, F = 900 MHz

