

### FEATURES

- Small Package
- Low Reverse Current
- Fast Switching Speed
- Surface Mount Package Ideally Suited for Automatic Insertion

### MARKING:T4



The marking bar indicates the cathode

Solid dot = Green molding compound device, if none, the normal device.

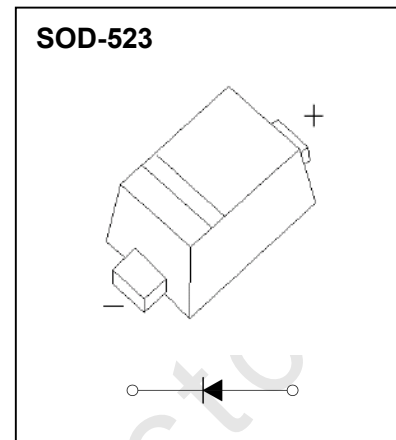

### MAXIMUM RATINGS (T<sub>a</sub>=25°C unless otherwise noted)

Symbol	Parameter	Value	Unit
V <sub>RM</sub>	Non-Repetitive Peak Reverse Voltage	100	V
V <sub>R</sub>	Reverse Voltage	75	V
V <sub>RRM</sub>	Peak Repetitive Reverse Voltage		
V <sub>RWM</sub>	Working Peak Reverse Voltage		
V <sub>R(RMS)</sub>	RMS Reverse Voltage	53	V
I <sub>O</sub>	Average Rectified Output Current	150	mA
I <sub>FM</sub>	Forward Continuous Current	300	mA
I <sub>FSM</sub>	Non-repetitive Peak Forward Surge Current@t=8.3ms	2	A
P <sub>D</sub>	Power Dissipation	150	mW
R <sub>θJA</sub>	Thermal Resistance from Junction to Ambient	833	°C/W
T <sub>j</sub>	Junction Temperature	150	°C
T <sub>stg</sub>	Storage Temperature	-55~+150	°C

### ELECTRICAL CHARACTERISTICS(T<sub>a</sub>=25°C unless otherwise specified)

Parameter	Symbol	Test conditions	Min	Typ	Max	Unit
Reverse voltage	V <sub>(BR)</sub>	I <sub>R</sub> =1μA	75			V
Reverse current	I <sub>R</sub>	V <sub>R</sub> =75V			1	μA
		V <sub>R</sub> =20V			25	nA
Forward voltage	V <sub>F</sub>	I <sub>F</sub> =1mA			0.715	V
		I <sub>F</sub> =10mA			0.855	V
		I <sub>F</sub> =50mA			1	V
		I <sub>F</sub> =150mA			1.25	V
Total capacitance	C <sub>tot</sub>	V <sub>R</sub> =0V, f=1MHz			2	pF
Reverse recovery time	t <sub>rr</sub>	I <sub>F</sub> = I <sub>R</sub> =10mA, I <sub>rr</sub> =0.1*I <sub>R</sub> , R <sub>L</sub> =100Ω			4	ns

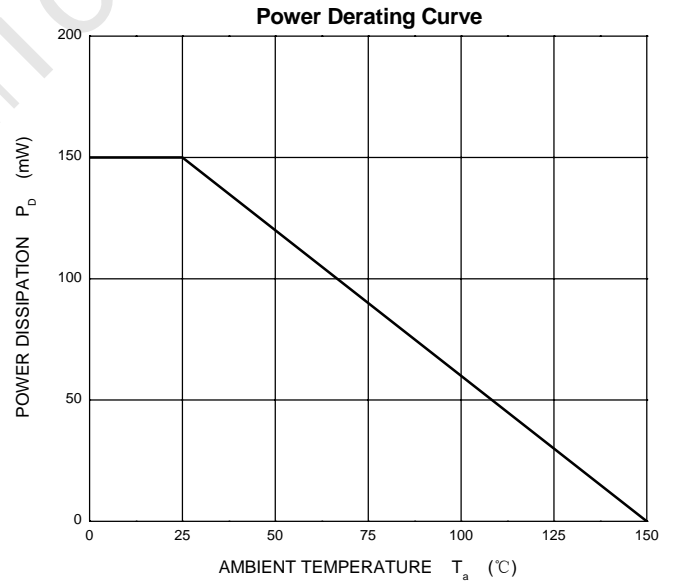
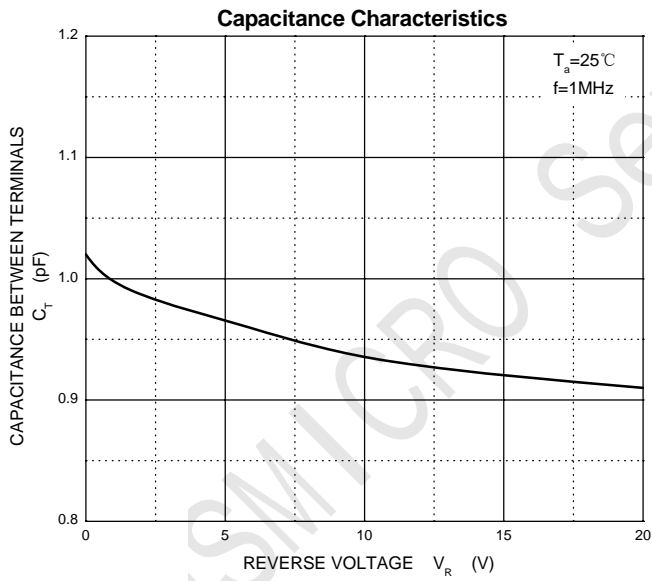
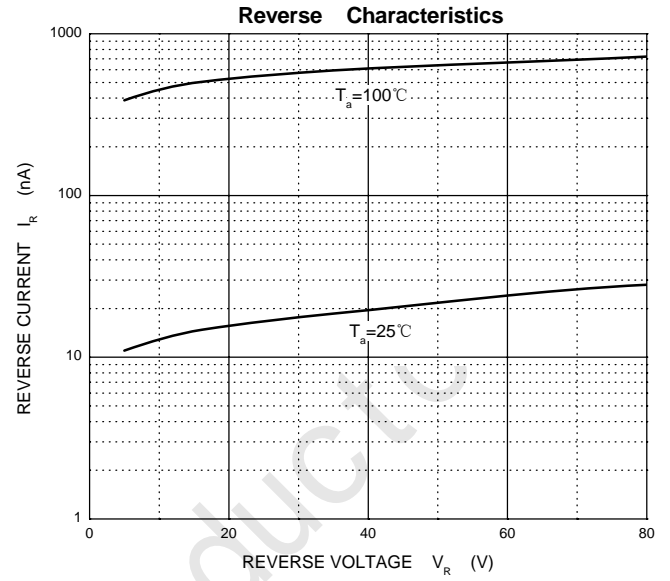
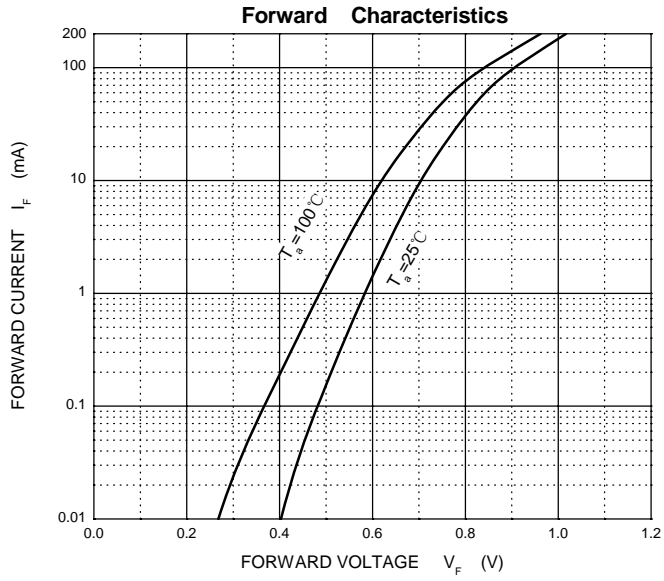

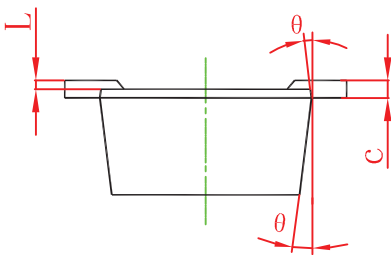
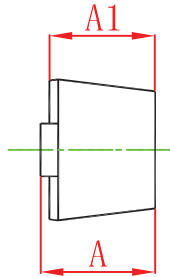
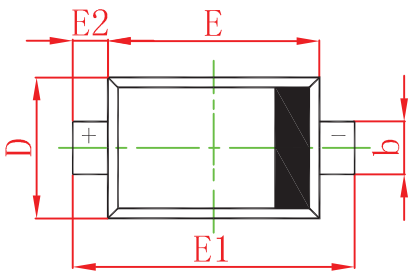

Symbol	Dimensions In Millimeters		Dimensions In Inches	
	Min	Max	Min	Max
A	0.510	0.770	0.020	0.031
A1	0.500	0.700	0.020	0.028
b	0.250	0.350	0.010	0.014
c	0.080	0.150	0.003	0.006
D	0.750	0.850	0.030	0.033
E	1.100	1.300	0.043	0.051
E1	1.500	1.700	0.059	0.067
E2	0.200 REF		0.008 REF	
L	0.010	0.070	0.001	0.003
$\theta$	7° REF		7° REF	

### SOD-523 Suggested Pad Layout

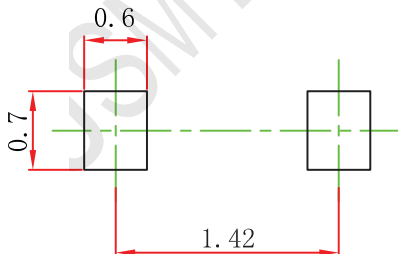

**Note:**

1. Controlling dimension: in millimeters.
2. General tolerance:  $\pm 0.05\text{mm}$ .
3. The pad layout is for reference purposes only.