



RFU620-10100

RFU62x

RFID

SICK
Sensor Intelligence.



Ordering information

Type	Part no.
RFU620-10100	1062599

Other models and accessories → www.sick.com/RFU62x



Detailed technical data

Features

Version	Mid Range
Product category	Write/read device with integrated antenna
Radio approval	Europe (ETSI EN 302 208-2 V1.4.1) South Africa (ETSI EN 302 208-2 V1.4.1)
Frequency band	UHF (860 MHz ... 960 MHz)
Carrier frequency	865.7 MHz ... 867.5 MHz
Output power	0.25 W (ERP, 24 dBm)
RFID standard	EPCglobal UHF Class 1 Generation 2, ISO/IEC 18000-6 C
Modulation	PR-ASK
Connection type	Ethernet
MTBF	23 years
Heating	Yes
Scanning range	Max. 1 m ¹⁾
Antenna	Integrated (circular polarized, axial ration typ. 2 dB, 100° field opening, front to back ratio > 7 dB)
Service functions	Parameter cloning with integrated microSD memory card slot or externally via CMC module in CDB620
Further functions	Cloning function (microSD memory card or system), diagnosis, updatable firmware, freely programmable data output format, Heartbeat, triggering, SICK AppSpace functionalities can be enabled with the SD card accessory SDK6U-P00100

¹⁾ Depending on transponder used and ambient conditions.

Interfaces

Ethernet	✓, TCP/IP
Function	Host, AUX
Data transmission rate	10/100 MBit/s

PROFINET	✓
Function	PROFINET Single Port, PROFINET Dual Port (optional via external connection module CDF600-2)
Data transmission rate	10/100 MBit/s
EtherNet/IP™	✓
Data transmission rate	10/100 MBit/s
Serial	✓, RS-232, RS-422, RS-485
Data transmission rate	0.3 kBaud ... 115.2 kBaud, AUX: 57.6 kBaud (RS-232)
CAN	✓
Remark	CSN (SICK CAN Sensor Network)
Function	Host
PROFIBUS DP	✓
Type of fieldbus integration	Optional over external fieldbus module CDF600-2
DeviceNet™	✓
Type of fieldbus integration	Optional available externally
Switching inputs	4 ("Sensor 1", "Sensor 2", 2 inputs via optional parameter storage CMC600 in CDB620/CDM420)
Switching outputs	4 ("Result 1", "Result 2", 2 outputs via optional parameter storage CMC600 in CDB620/CDM420)
Optical indicators	11 LEDs (function configurable via SOPAS ET, alternatively controlling with sw commands, status displays)
Configuration software	SOPAS ET

Mechanics/electronics

Electrical connection	1 x M12, 17-pin male connector 1 x M12, 4-pin Ethernet female connector
Operating voltage	10 V DC ... 30 V DC ¹⁾
Power consumption	8 W, with heating typ. 16 W
Housing	Aluminum die cast Plastic (PPS)
Enclosure rating	IP67
Protection class	III
Weight	780 g
Dimensions (L x W x H)	137 mm x 131 mm x 56 mm

¹⁾ With heating 20 V DC ... 30 V DC.

Ambient data

Electromagnetic compatibility (EMC)	EN 61000-6-3 (2007) + A1 (2011) / EN 61000-6-2 (2005)
Vibration resistance	EN 60068-2-6 (2008-02)
Shock resistance	EN 60068-2-27 (2009-05)
Ambient operating temperature	-40 °C ... +50 °C
Storage temperature	-40 °C ... +70 °C
Permissible relative humidity	90 %, Non-condensing

Classifications

ECI@ss 5.0	27280401
-------------------	----------

ECl@ss 5.1.4	27280401
ECl@ss 6.0	27280401
ECl@ss 6.2	27280401
ECl@ss 7.0	27280401
ECl@ss 8.0	27280401
ECl@ss 8.1	27280401
ECl@ss 9.0	27280401
ETIM 6.0	EC002998
UNSPSC 16.0901	52161523

Dimensional drawing (Dimensions in mm (inch))

RFU62x

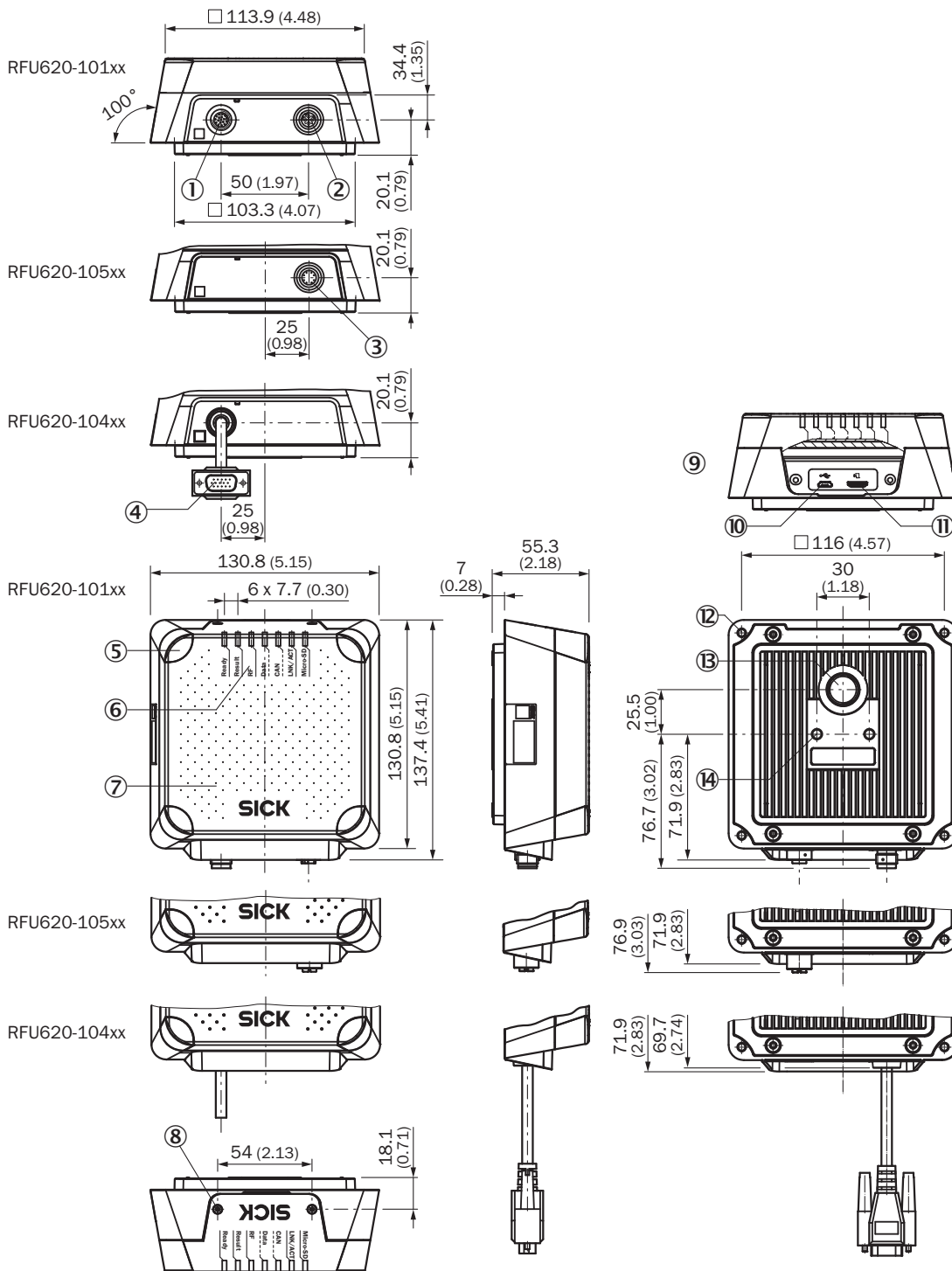

- ① "Power/AUX/CAN/I/O" connection, 17-pin M12 male connector, A-coded
 ② "Ethernet" connection, 4-pin M12 female connector, D-coded
 ③ "Ethernet" connection, 8-pin M12 female connector, X-coded
 ④ "Power/HOST/AUX/CAN/I/O" connection, 15-pin D-Sub HD male connector, cable 0,9 m

- ⑤ 4 x LED multi-color (process feedback)
 ⑥ 7 x LED for status display
 ⑦ Cover with integrated antenna
 ⑧ Screw (Torx T8), captive (2 x), for side cover
 ⑨ Side cover opened



- ⑩ USB socket, type Micro-B
 ⑪ Slot for microSD memory card
 ⑫ Blind hole thread M5, 9 mm deep (4 x), for alternatively mounting
 ⑬ Pressure compensation valve (ventilation element)
 ⑭ M6 blind tapped holes, 7 mm deep (2 x), for mounting

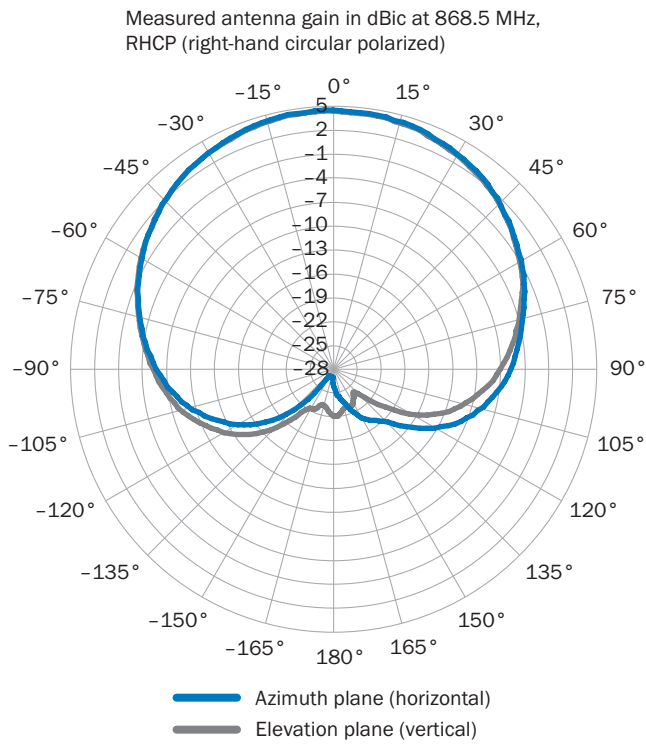



Radiation pattern



Recommended accessories

Other models and accessories → www.sick.com/RFU62x

	Brief description	Type	Part no.
Mounting brackets and plates			
	Simple mounting bracket	Mounting bracket	2071067
Modules			
	Small connection module for one sensor, 4 cable glands, base for CMC600	CDB620-001	1042256
	Fieldbus proxy/gateway for connecting identification sensors to PROFIBUS-DP networks (PROFIBUS interface: 2 x M12, male connector/female connector, 5-pin)	CDF600-2100	1058965
	Fieldbus proxy/gateway for connecting one identification sensor to PROFINET-IO networks (interface 2 x M12, female connector/female connector, 4-pin)	CDF600-2200	1062460
Plug connectors and cables			
	Head A: female connector, M12, 17-pin, straight Head B: male connector, D-Sub-HD, 15-pin, straight Cable: Power, serial, CAN, digital I/Os, shielded, 2 m	Connection cable (male connector - female connector)	2055419

	Brief description	Type	Part no.
	Head A: male connector, M12, 4-pin, straight, D-coded Head B: male connector, RJ45, 8-pin, straight Cable: Ethernet, twisted pair, PUR, halogen-free, shielded, 2 m	SSL-2J04-G02ME	6034414
	Head A: male connector, USB-A Head B: male connector, Micro-B Cable: USB 2.0, unshielded, 2 m	USB cable	6036106
Storage media			
	Code for activating the SICK AppSpace functions. MicroSD memory card with 1 GB for industrial use.	SDK6U-P00100 SICK AppSpace	1076012
RFID transponder			
	UHF transponder, global, thermoplastic, 51.5 mm x 47.5 mm x 10 mm, Impinj Monza 4 QT	On-metal transponder (52 mm x 48 mm x 10 mm)	6052346

SICK AT A GLANCE

SICK is one of the leading manufacturers of intelligent sensors and sensor solutions for industrial applications. A unique range of products and services creates the perfect basis for controlling processes securely and efficiently, protecting individuals from accidents and preventing damage to the environment.

We have extensive experience in a wide range of industries and understand their processes and requirements. With intelligent sensors, we can deliver exactly what our customers need. In application centers in Europe, Asia and North America, system solutions are tested and optimized in accordance with customer specifications. All this makes us a reliable supplier and development partner.

Comprehensive services complete our offering: SICK LifeTime Services provide support throughout the machine life cycle and ensure safety and productivity.

For us, that is “Sensor Intelligence.”

WORLDWIDE PRESENCE:

Contacts and other locations –www.sick.com