

PART
NAME

ALUMINUM INSTRUMENT CASE

PART
No.

IA-6160

REVISION
DATE

-

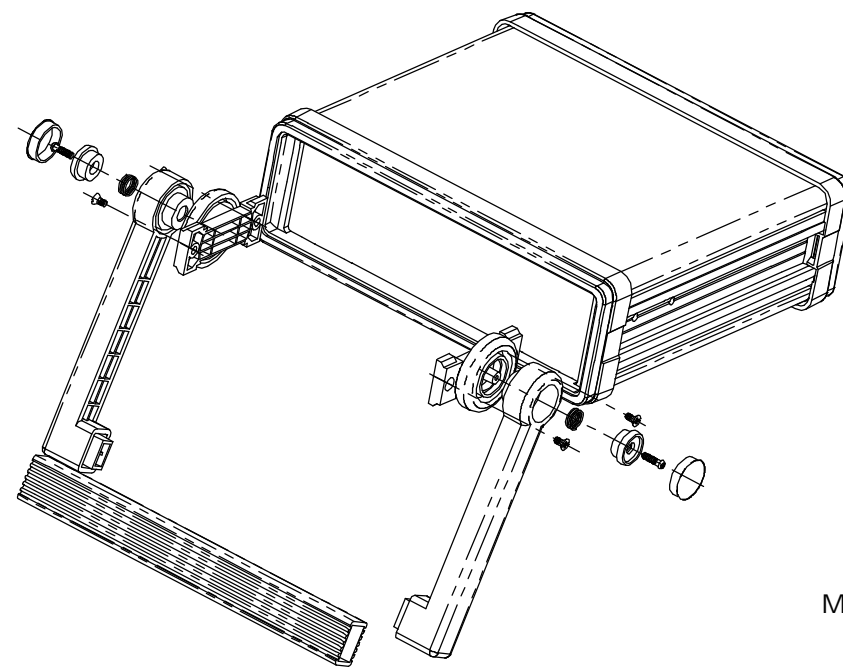
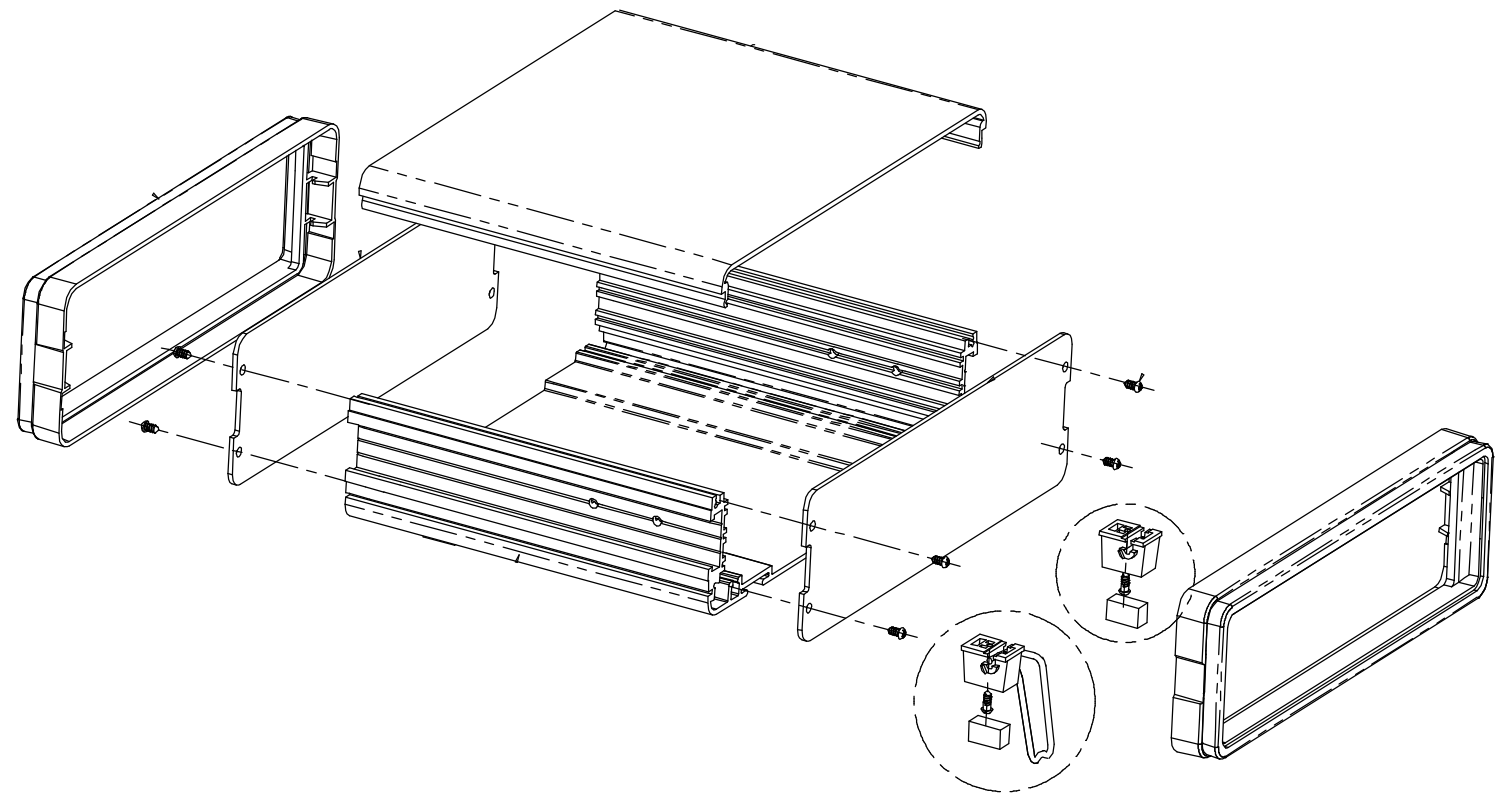
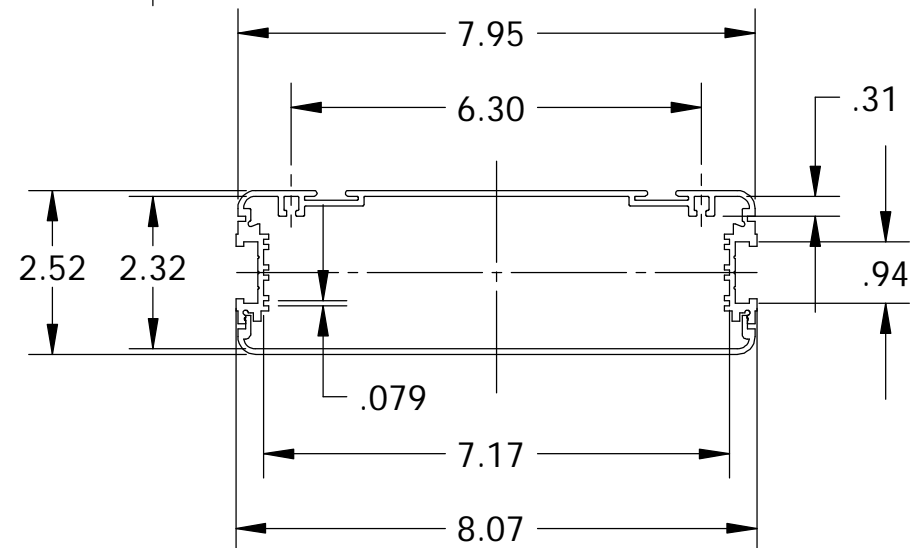
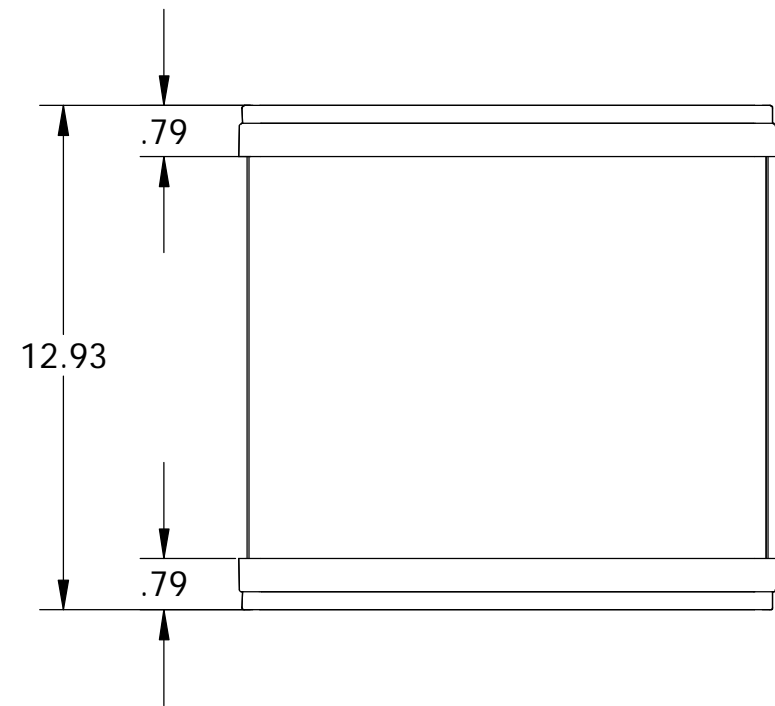
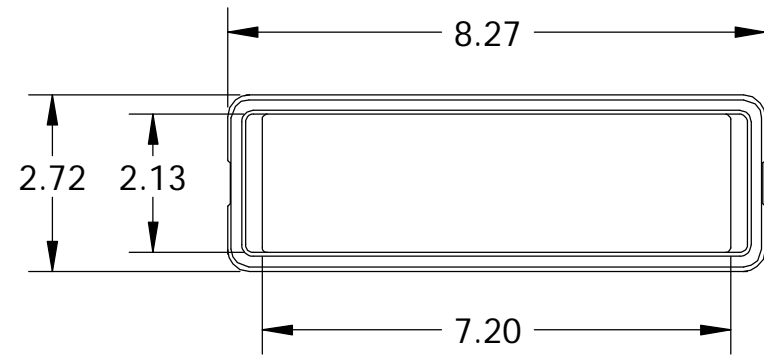

MATERIAL AND FINISH:
BODY: EARTH TONE POWDER COATED ALUMINUM EXTRUSION
BEZELS: LIGHT BROWN PLASTIC
PANELS: NATURAL ALUMINUM
HANDLE: LIGHT GRAY PLASTIC/ANODIZED ALUMINUM EXTRUSION

DIMENSIONS ARE IN INCHES