

ESD protection for high speed interface

Main applications

Where transient overvoltage protection in ESD sensitive equipment is required, such as:

- Computers
- Printers
- Communication systems
- Cellular phones handsets and accessories
- Video equipment

Features

- Ultra low capacitance 1.25 pF max.
- Bi-directional protection
- RoHS package

Description

The ESDAULC6-3Bxx is a monolithic application specific discrete device dedicated to ESD protection of high speed interfaces such as USB2.0.

The device is ideal for applications where both reduced print circuit board space and power absorption capability are required.

Benefits

- Ultra low capacitance bidirectional ESD protection
- Low PCB space consumption: 2.5 mm² max footprint (1.7 mm² for Flip-Chip)
- Enhanced ESD protection:
 - 15 kV contact discharge
 - 15 kV air discharge
- No insertion loss to 3.0 GHz
- Ultra low leakage current
- High reliability offered by monolithic integration

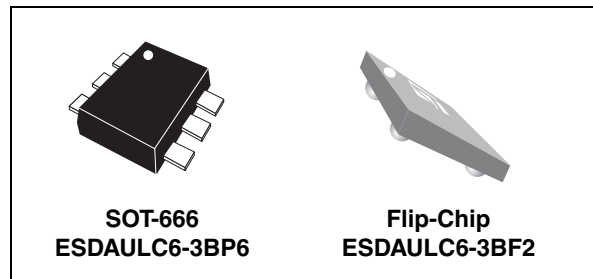

Figure 1. Functional diagram

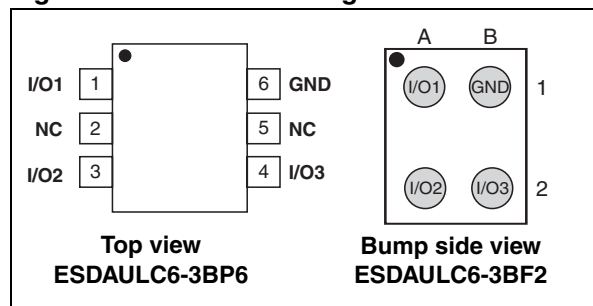

Figure 2. Pin configuration

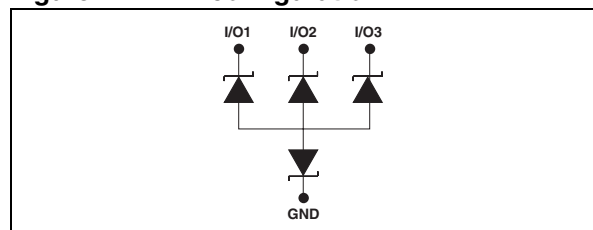

Table 1. Order codes

Part number	Marking
ESDAULC6-3BP6	3
ESDAULC6-3BF2	3B

Complies with the following standards:

IEC 61000-4-2 level 4:

- 8 kV (contact discharge)
- 15 kV (air discharge)

MIL STD 883G-Method 3015-7: class 3B

- HBM (Human Body Model)

1 Characteristics

Table 2. Absolute maximum ratings

Symbol	Parameter		Value (min.)	Unit
V _{PP}	Peak pulse voltage ⁽¹⁾	IEC 61000-4-2 contact discharge	15	kV
		IEC 61000-4-2 air discharge	15	
T _j	Maximum operating junction temperature		150	°C
T _{stg}	Storage temperature range		-55 to +150	°C
T _L	Maximum lead temperature for soldering during 10 s at 5 mm for case		260	°C

1. For a surge greater than the maximum values, the diode will fail in short-circuit.

Table 3. Electrical characteristics (T_{amb} = 25° C)

Symbol	Parameter					
V _{RM}	Stand-off voltage					
V _{BR}	Breakdown voltage					
V _{CL}	Clamping voltage					
I _{RM}	Leakage current					
I _{PP}	Peak pulse current					
αT	Voltage temperature coefficient					
C	Capacitance					
R _d	Dynamic resistance					
Parameter	Test condition		Min	Typ	Max	Unit
V _{BR} ⁽¹⁾	I _R = 1 mA		6.0		9.2	V
I _{RM}	V _{RM} = 5 V				0.5	μA
R _d	Square pulse, I _{PP} = 6 A, t _p = 2.5 μs			1.4		Ω
αT					1.2	10 ⁻⁴ /°C
C _{i/o-i/o}	V _{I/O} = 0 V, F = 1 MHz, V _{OSC} = 30 mV	SOT-666		1.0	1.25	pF
		Flip-Chip		1.25	1.5	
	V _{I/O} = 1.65 V, V _{CC} = 4.3 V, F = 1 MHz, V _{OSC} = 400 mV	SOT-666		0.75	0.9	
		Flip-Chip		0.9	1.20	

1. Same value for I/O to I/O and I/O to GND

Figure 3. Relative variation of peak pulse power versus initial junction temperature (SOT-666)

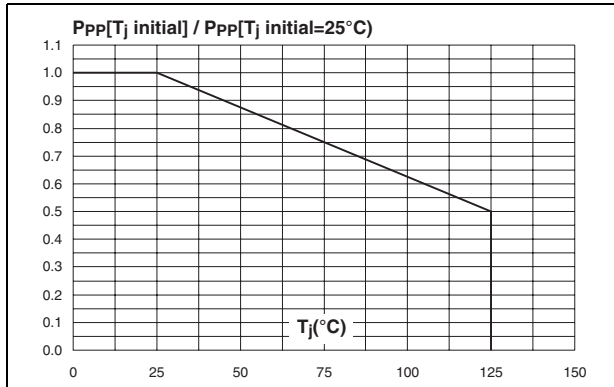

Figure 4. Relative variation of peak pulse power versus initial junction temperature (Flip-Chip)

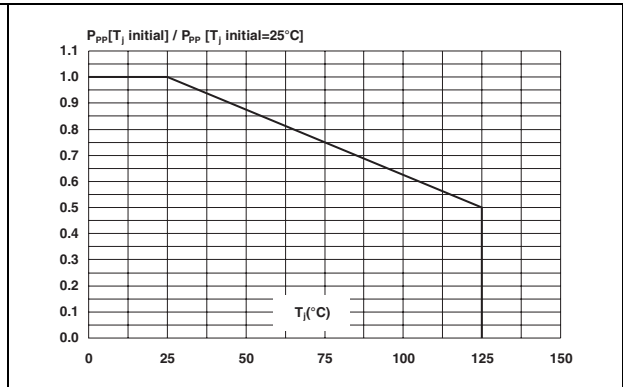

Figure 5. Peak pulse power versus exponential pulse duration (SOT-666)

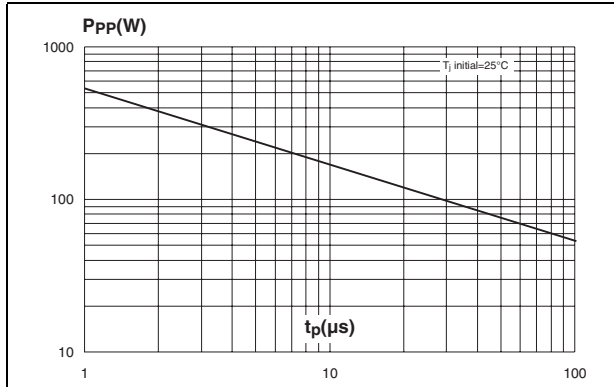

Figure 6. Peak pulse power versus exponential pulse duration (Flip-Chip)

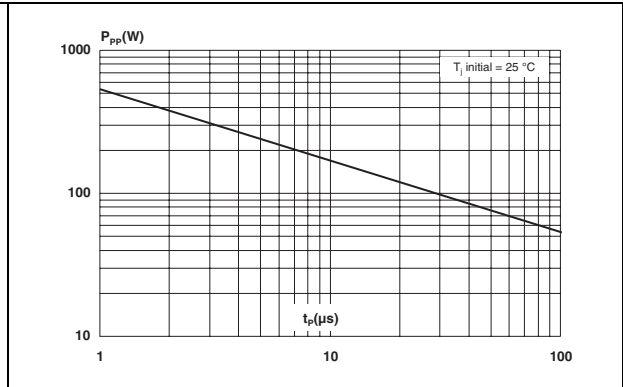

Figure 7. Clamping voltage versus peak pulse current (typical values) (SOT-666)

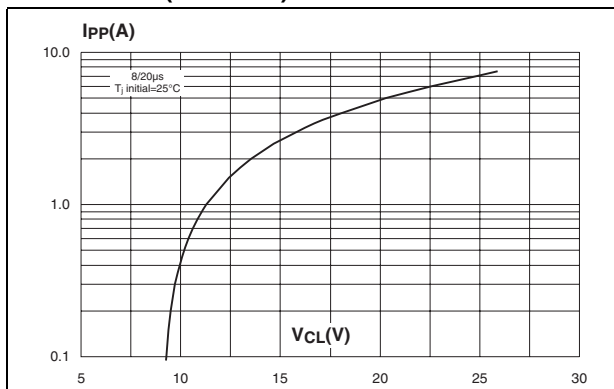

Figure 8. Clamping voltage versus peak pulse current (typical values) (Flip-Chip)

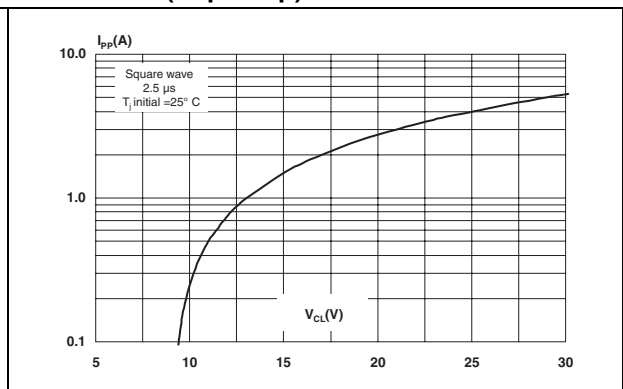

Figure 9. Junction capacitance versus reverse voltage applied (typical values) (SOT-666)

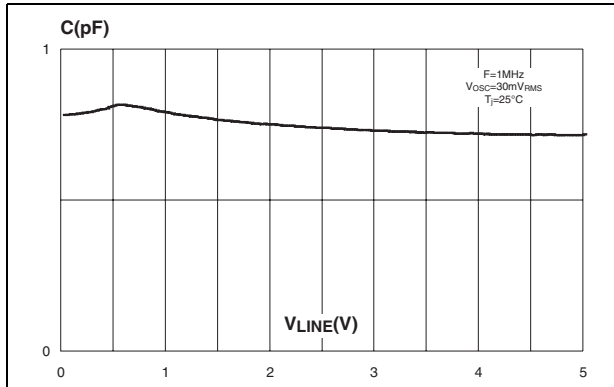

Figure 10. Junction capacitance versus reverse voltage applied (typical values) (Flip-Chip)

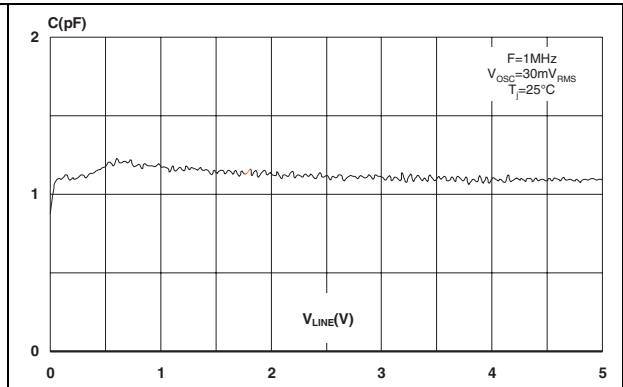

Figure 11. Relative variation of leakage current versus junction temperature (typical values) (SOT-666)

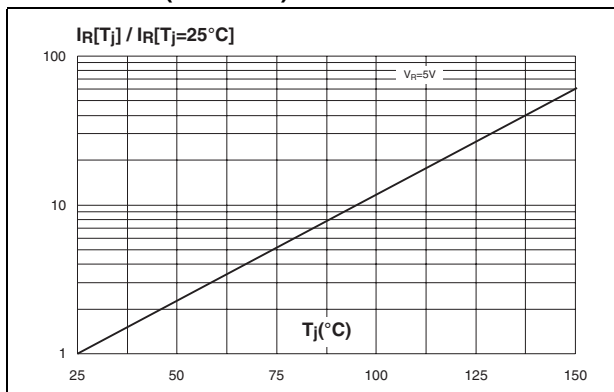

Figure 12. Relative variation of leakage current versus junction temperature (typical values) (Flip-Chip)

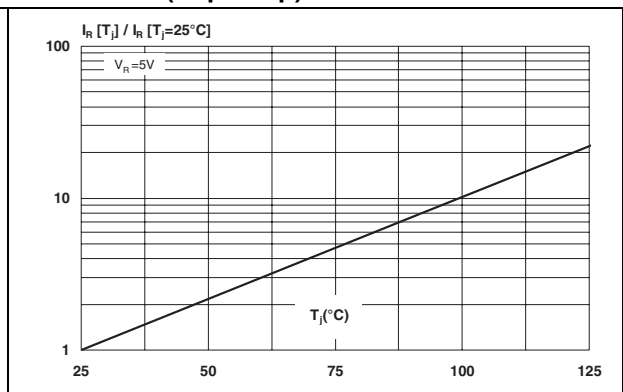

Figure 13. Remaining voltage after ESDAULC6-3BP6 during ESD 15 kV positive surge (air discharge) (SOT-666)

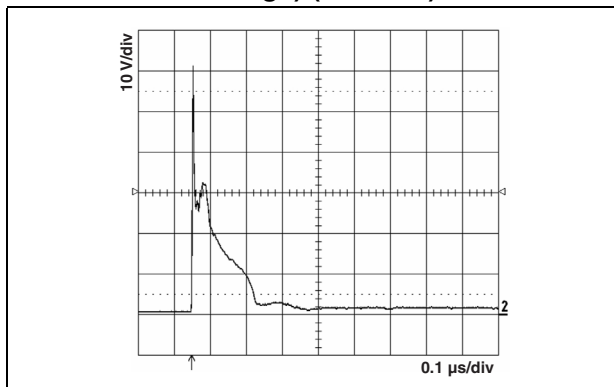

Figure 14. Remaining voltage after ESDAULC6-3BF2 during ESD 15 kV positive surge (air discharge) (Flip-Chip)

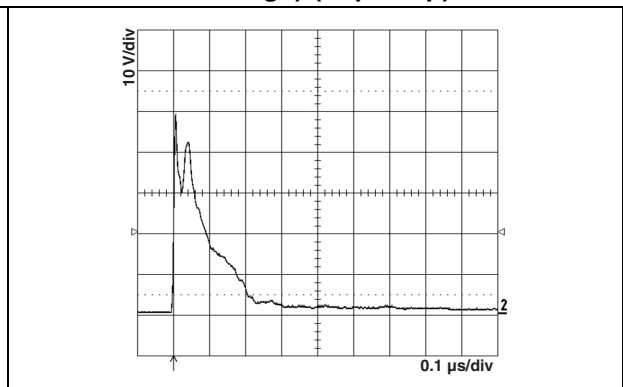

Figure 15. Remaining voltage after ESDAULC6-3BP6 during ESD 15 kV negative surge (air discharge) (SOT-666)

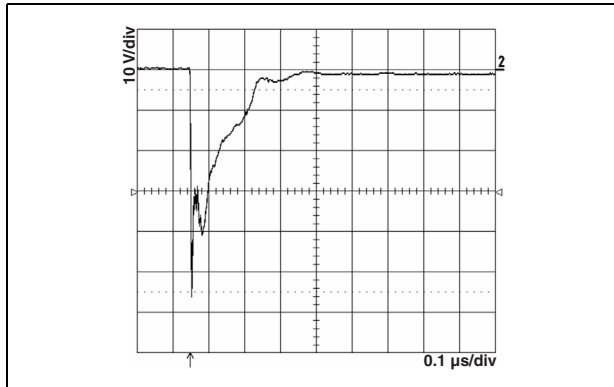

Figure 16. Remaining voltage after ESDAULC6-3BF2 during ESD 15 kV negative surge (air discharge) (Flip-Chip)

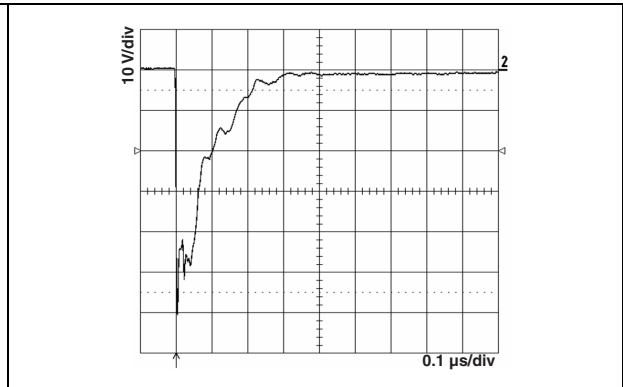

Figure 17. S21 attenuation measurement results of each channel (SOT-666)

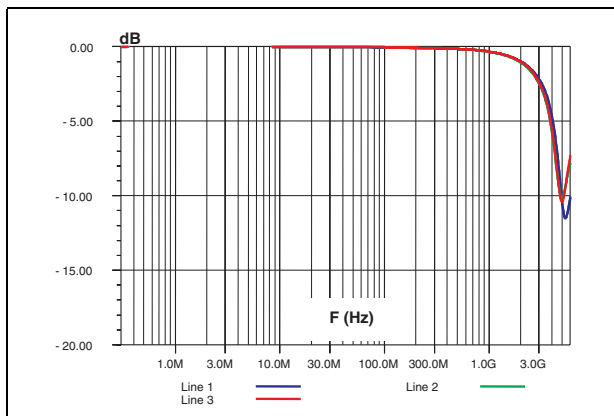

Figure 18. S21 attenuation measurement results of channel 1 (Flip-Chip)

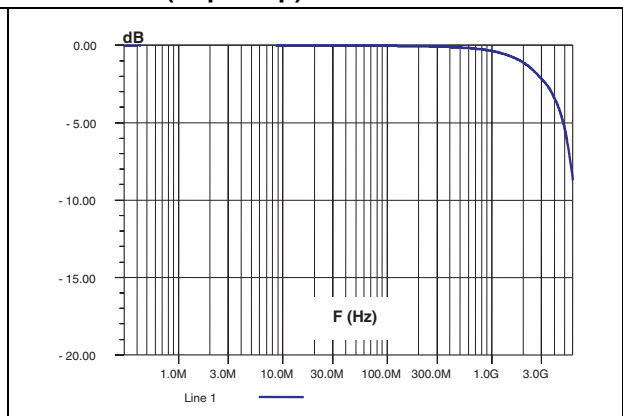

Figure 19. Analog crosstalk measurements between channels (SOT-666)

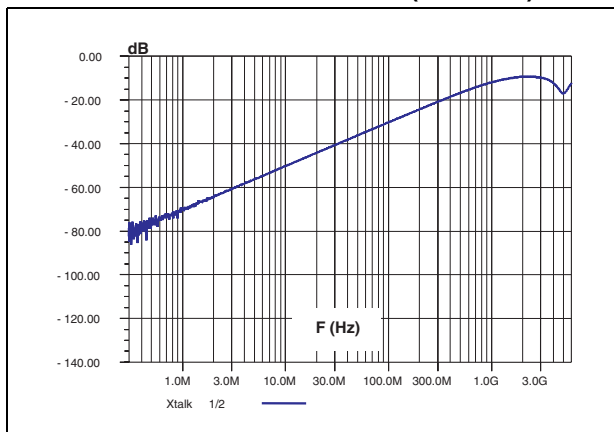
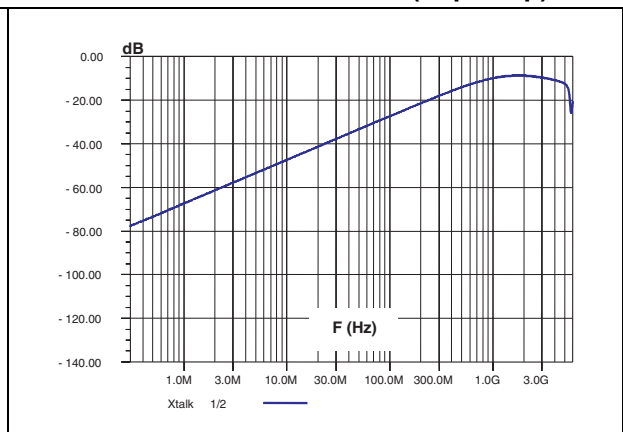

Figure 20. Analog crosstalk measurements between channels (Flip-Chip)



2 Application examples

Figure 21. USB2.0 (high speed) protection application schematic

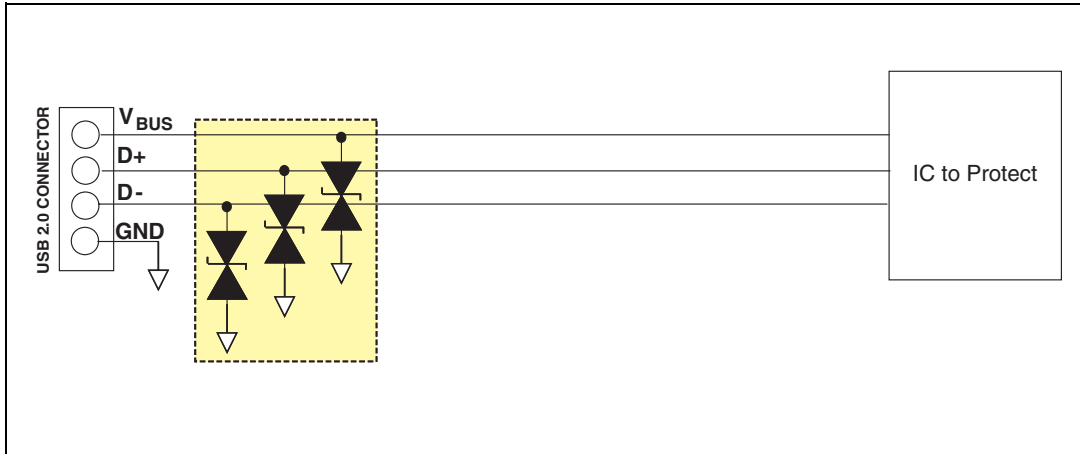

Figure 22. Audio jack protection application schematic

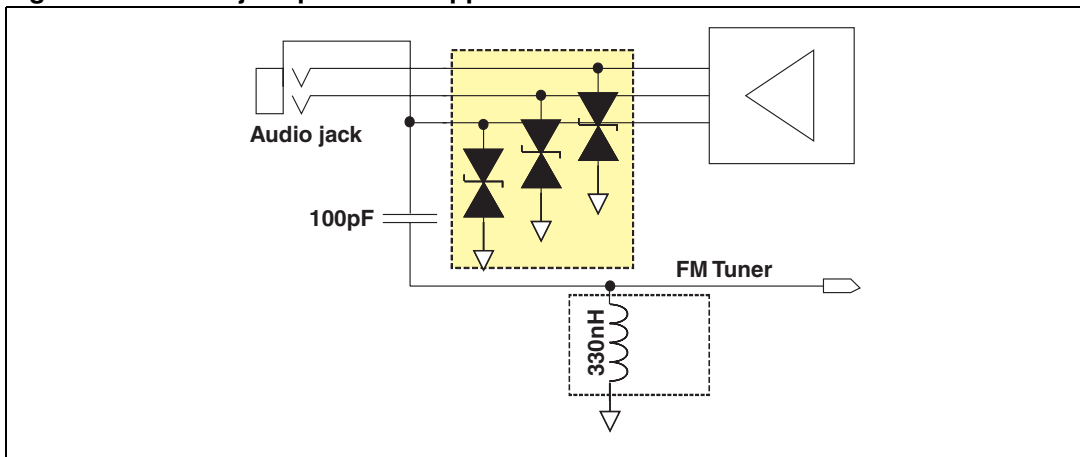
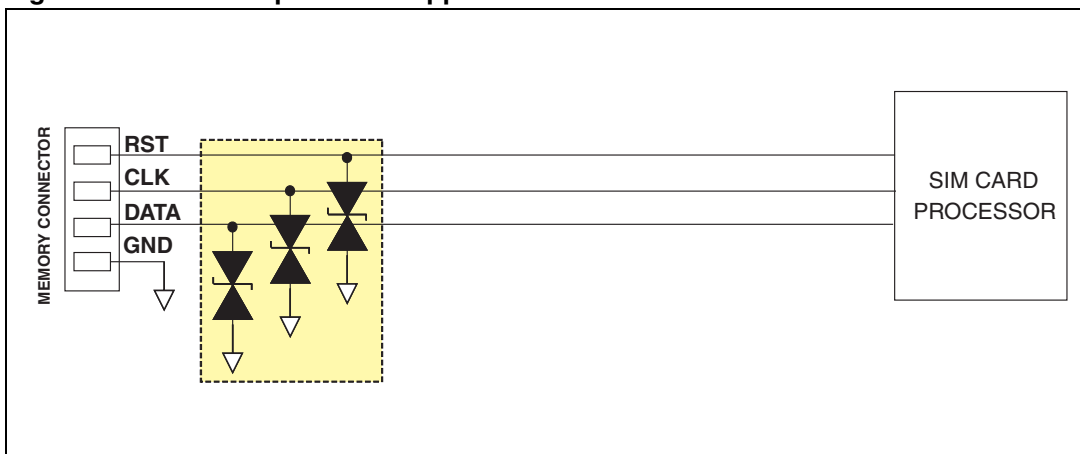
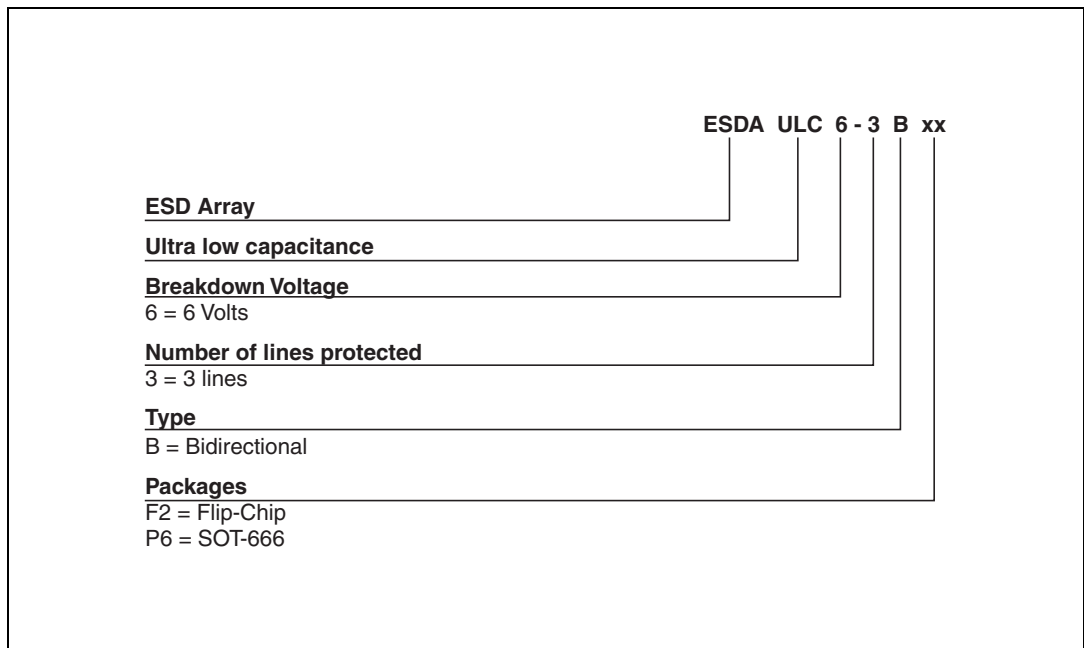

Figure 23. SIM card protection application schematic



3 Ordering information scheme



4 Package information

- Epoxy meets UL 94, V0

Table 4. SOT-666 dimensions

Ref.	Dimensions					
	Millimeters			Inches		
	Min.	Typ.	Max.	Min.	Typ.	Max.
A	0.45		0.60	0.018		0.024
A3	0.08		0.18	0.003		0.007
b	0.17		0.34	0.007		0.013
b1	0.19	0.27	0.34	0.007	0.011	0.013
D	1.50		1.70	0.059		0.067
E	1.50		1.70	0.059		0.067
E1	1.10		1.30	0.043		0.051
e		0.50			0.020	
L1		0.19			0.007	
L2	0.10		0.30	0.004		0.012
L3		0.10			0.004	

Figure 24. SOT-666 footprint (dimensions in mm)

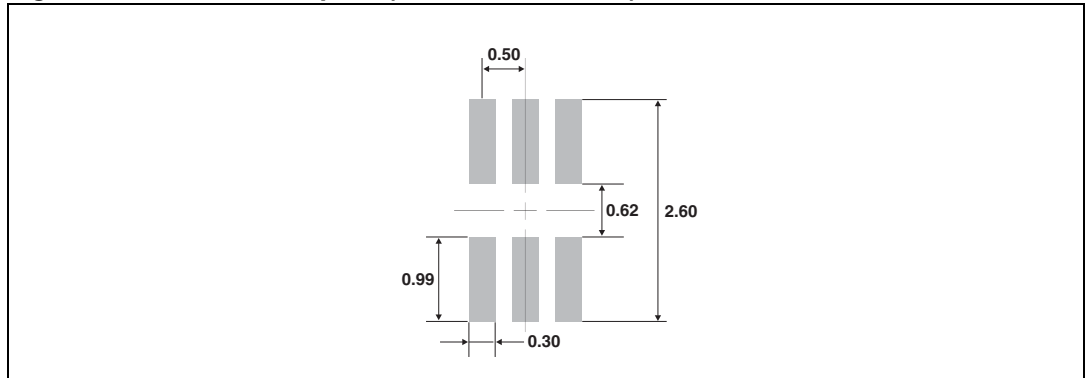

Figure 25. Flip-Chip dimensions

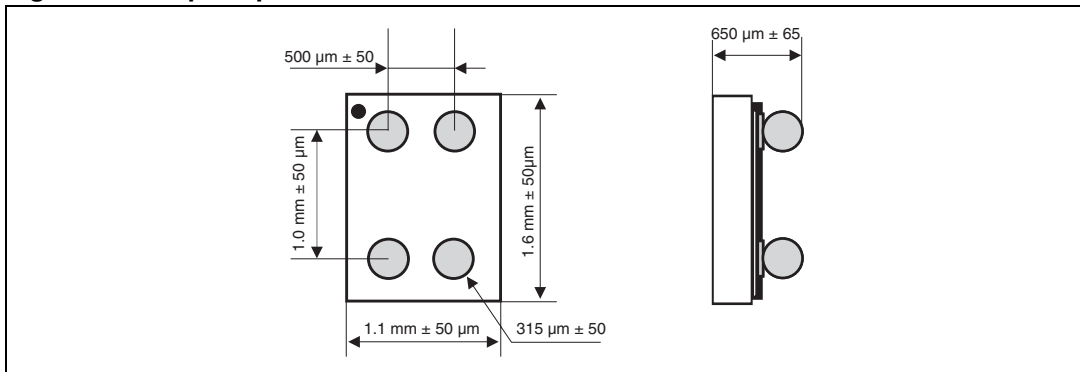

Figure 26. Flip-Chip footprint

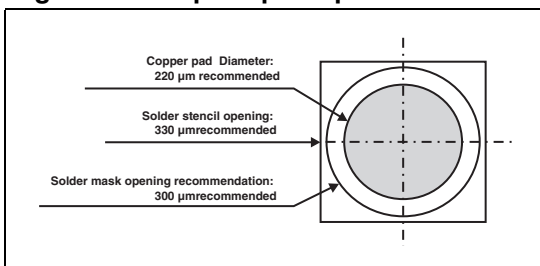

Figure 27. Flip-Chip marking

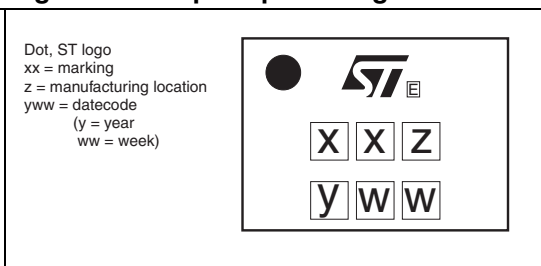
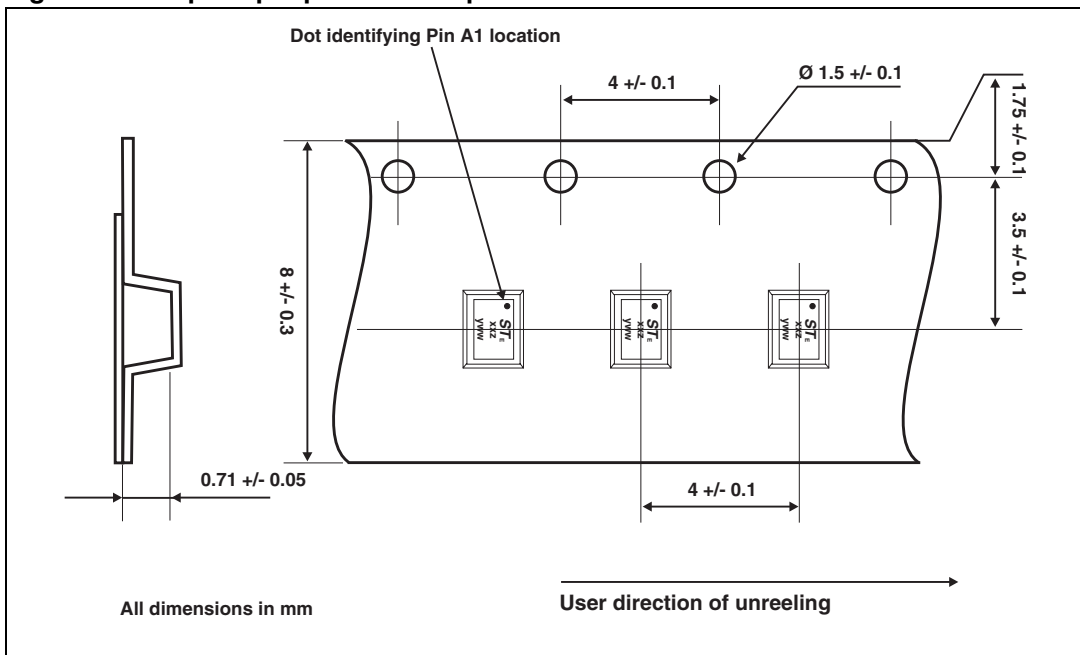

Figure 28. Flip-Chip tape and reel specifications



In order to meet environmental requirements, ST offers these devices in ECOPACK® packages. These packages have a lead-free second level interconnect. The category of second level interconnect is marked on the package and on the inner box label, in compliance with JEDEC Standard JESD97. The maximum ratings related to soldering conditions are also marked on the inner box label. ECOPACK is an ST trademark. ECOPACK specifications are available at: www.st.com.

5 Ordering information

Table 5. Ordering information

Part number	Marking	Package	Weight	Base qty	Delivery mode
ESDAULC6-3BP6	3	SOT-666	2.9 mg	5000	Tape and reel
ESDAULC6-3BF2	3B	Flip-Chip	2.22 mg	5000	Tape and reel

6 Revision history

Table 6. Revision history

Datet	Revision	Changes
03-Jul-2007	1	Initial release

Please Read Carefully:

Information in this document is provided solely in connection with ST products. STMicroelectronics NV and its subsidiaries ("ST") reserve the right to make changes, corrections, modifications or improvements, to this document, and the products and services described herein at any time, without notice.

All ST products are sold pursuant to ST's terms and conditions of sale.

Purchasers are solely responsible for the choice, selection and use of the ST products and services described herein, and ST assumes no liability whatsoever relating to the choice, selection or use of the ST products and services described herein.

No license, express or implied, by estoppel or otherwise, to any intellectual property rights is granted under this document. If any part of this document refers to any third party products or services it shall not be deemed a license grant by ST for the use of such third party products or services, or any intellectual property contained therein or considered as a warranty covering the use in any manner whatsoever of such third party products or services or any intellectual property contained therein.

UNLESS OTHERWISE SET FORTH IN ST'S TERMS AND CONDITIONS OF SALE ST DISCLAIMS ANY EXPRESS OR IMPLIED WARRANTY WITH RESPECT TO THE USE AND/OR SALE OF ST PRODUCTS INCLUDING WITHOUT LIMITATION IMPLIED WARRANTIES OF MERCHANTABILITY, FITNESS FOR A PARTICULAR PURPOSE (AND THEIR EQUIVALENTS UNDER THE LAWS OF ANY JURISDICTION), OR INFRINGEMENT OF ANY PATENT, COPYRIGHT OR OTHER INTELLECTUAL PROPERTY RIGHT.

UNLESS EXPRESSLY APPROVED IN WRITING BY AN AUTHORIZED ST REPRESENTATIVE, ST PRODUCTS ARE NOT RECOMMENDED, AUTHORIZED OR WARRANTED FOR USE IN MILITARY, AIR CRAFT, SPACE, LIFE SAVING, OR LIFE SUSTAINING APPLICATIONS, NOR IN PRODUCTS OR SYSTEMS WHERE FAILURE OR MALFUNCTION MAY RESULT IN PERSONAL INJURY, DEATH, OR SEVERE PROPERTY OR ENVIRONMENTAL DAMAGE. ST PRODUCTS WHICH ARE NOT SPECIFIED AS "AUTOMOTIVE GRADE" MAY ONLY BE USED IN AUTOMOTIVE APPLICATIONS AT USER'S OWN RISK.

Resale of ST products with provisions different from the statements and/or technical features set forth in this document shall immediately void any warranty granted by ST for the ST product or service described herein and shall not create or extend in any manner whatsoever, any liability of ST.

ST and the ST logo are trademarks or registered trademarks of ST in various countries.

Information in this document supersedes and replaces all information previously supplied.

The ST logo is a registered trademark of STMicroelectronics. All other names are the property of their respective owners.

© 2007 STMicroelectronics - All rights reserved

STMicroelectronics group of companies

Australia - Belgium - Brazil - Canada - China - Czech Republic - Finland - France - Germany - Hong Kong - India - Israel - Italy - Japan - Malaysia - Malta - Morocco - Singapore - Spain - Sweden - Switzerland - United Kingdom - United States of America

www.st.com