

D-2000 Series (Wire-to-Board, Wire-to-Panel and Wire-to-Wire)

List of Products by Application

D-2000 Series connectors are the next smallest in Dynamic Series, yet they can meet requirements of connectors for most industrial applications. They can be used

mainly for signal applications. Signal lines under 250 V are of 2.5 mm pitch, which can accept 18 AWG wires. (5 A max. per position)

D-2000 Series have several unique characteristics such as center-lock method for effective use of PCB properties, contact-entrance method for low profile shapes, and others.

D-2000 Series

**D-2100S
1-Row Type**

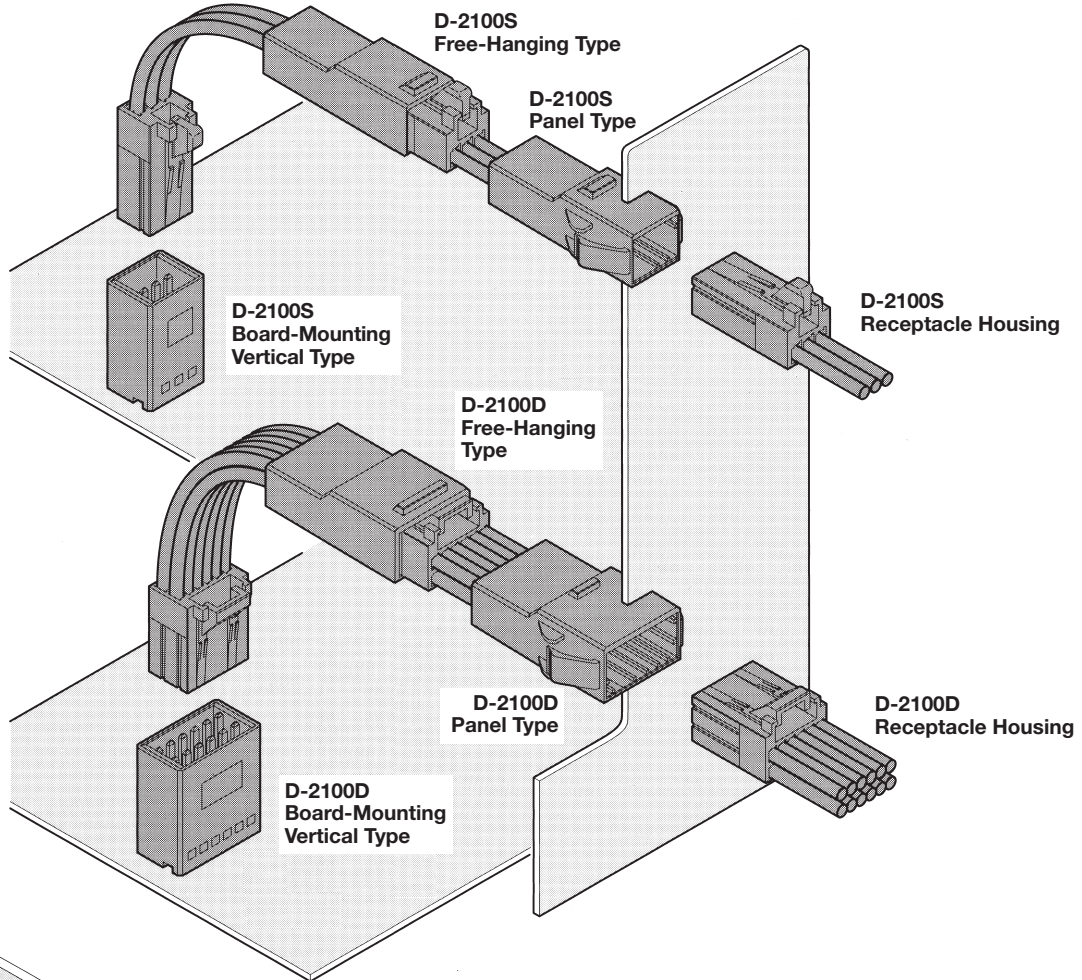

**D-2100D
2-Row Type**

**D-2100M
Drawer Type**

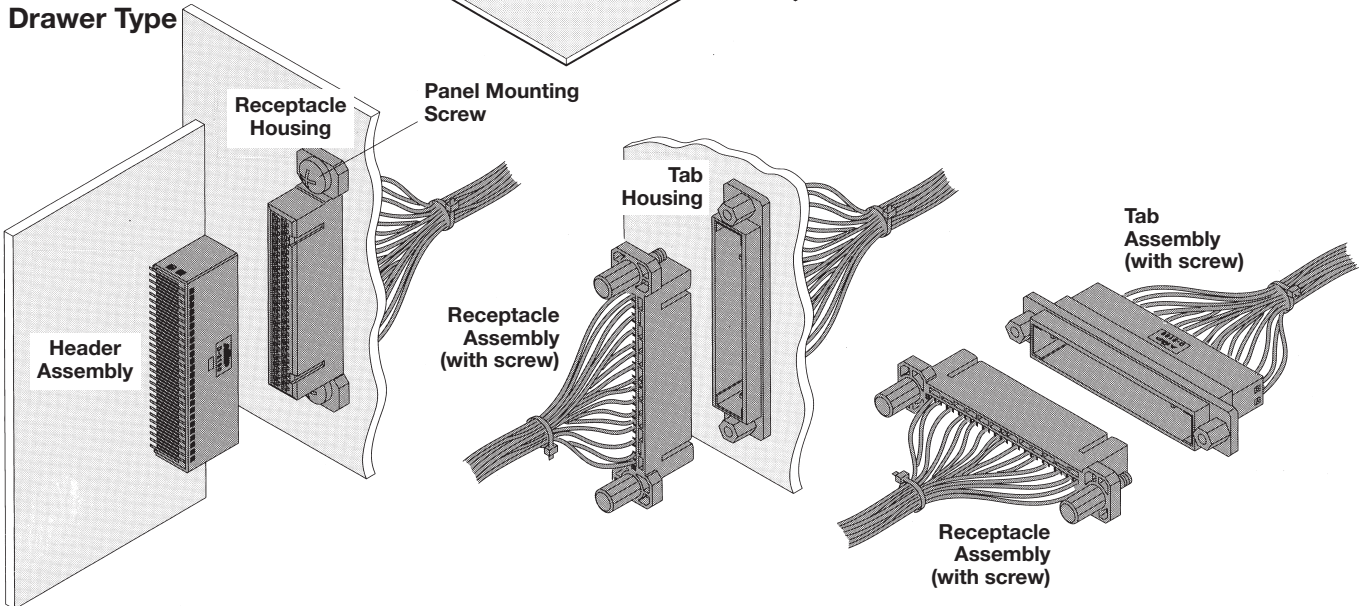

D-2000 Series (Continued)

Performance Specifications

Item	Pitch	2.5mm
Voltage Rating		250 VAC
Current Rating		1-position : 5A 3-position : 5A 6-position : 5A 8-position : 4.5A 12-position : 4A 20-position : 3.2A (when using #18 AWG wire)
Contact Resistance		10 mΩ max.
Dielectric Withstanding Voltage		1,500 V (1minute)
Operating Temperature		-55° ~ +105°C

*When connectors are used singly.

Material and Finish

Description	Material	Finish
Receptacle contact Tab contact	Copper alloy	Contact area 0.38 μm min. gold plating underplated nickel
Tab post	Copper alloy	Contact area 0.38 μm min. gold plating — Contact tail tin plated underplated nickel
Housing	UL94V-0 rated glass filled polyester (PBT)	

D-2000 Series (Continued)

Performance Specifications

(Continued)

Specifications and Instruction Sheet

Instruction Sheet-Hand Tools

Specifications and Instruction Sheet

Product Specification	108-5619, 108-5659 (Drawer Type)
Testing Report	501-5261
Application Specification	114-5258
Instruction Sheet-Extraction Tool	411-5900

Instruction Sheet-Manual Tool

Tool Part No.	IS No.
91576-1	408-8547
91595-1	408-8547

*Remember to obtain Instruction Sheets when you choose to use these tools.

Extraction Tool **Part Number: 1276716-1 (411-5900)**

Keying Plug **Part Number: 641994-1**

Tab Contact Cutting Tool **Part Number: 919041-2**

Safety Specifications

The safety specifications listed below are approved on specific part numbers. Contact our Sales Department to check if the part numbers you use are approved or not. Keep in mind that there are instances where values differ from those given by Tyco Electronics Specifications.

Series	D-2100 Series			D-2100M Drawer Type		
	Voltage Rating	Current Rating	Temperature Rating	Voltage Rating	Current Rating	Temperature Rating
Specifications 108-5619 (Standard) 108-5659 (Drawer Type)	250 V	5A (1 position)	-55° to +105°C	250 V	2.6A (with #20 AWG) 50 position	-55° to +105°C
UL File No. E28476	Determined by requirements of equipment in use.	Determined by requirements of equipment in use.	—			
CSA Report No. LR7189	250 V	#24~28 AWG : 3.3A #18~22 AWG : 5A	—			
TÜV License No. R 9950679	125 V	5A	-55° to +105°C			

D-2000 Series

D-2000 Series (Continued)

D-2 Contact and Application Tooling

Crimp Type

(Gold plating : 0.38 μm)

Receptacle Contact

(Used on Receptacle Housing)

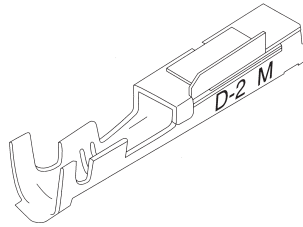

Tab Contact

(Used on Tab Housing)

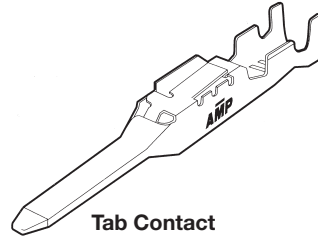

Wire Range		Wire Ins. Diameter	Wire Range Mark	Contact Part Number*		Application Tooling Part Number		
AWG	mm ²			Receptacle Contact	Tab Contact	Mini-Applicator**	Hand Tool	
28	0.08	0.88~1.5	S	ST.	1318106-1	1318110-1	**	—
26	0.12			LP.	1318108-1	1318112-1	**	91576-1
24	0.20	1.11~1.87	M	ST.	1318105-1	1318109-1	**	—
22	0.30			LP.	1318107-1	1318111-1	**	91595-1
20	0.50							
18	0.85							

* Strip Form contacts are for use with Mini-Applicators (automachines) and Loose-Piece contacts are for Hand Tools.

**Mini-Applicators are for use with automachines. (For part numbers, contact Technical Support.)

Application Tooling

AMP-3K/40 and AMP-5K/40 Terminating Machines

The AMP-3K/40 and AMP-5K/40 Terminators are designed for customers that require the increased output and quality of a semiautomatic machine at a competitive price. By incorporating the most commonly requested features as standard and offering a long list of optional equipment, these terminators offer flexibility to meet the specific needs of various applications at the lowest possible cost.

- 3,000 lb. [1361 kg] max. crimp force (AMP-3K/40)
- 5,000 lb. [2268 kg] max. crimp force (AMP-5K/40)
- Toolless removal of applicators and guards
- Jog capability
- Quiet, fast operation — 80/76 dBA and cycle time less than 0.400 seconds
- Accepts Heavy Duty Mini style applicators
- Wide range of optional equipment such as toolless precision crimp height adjust, batch counter, CQM capability and work light
- Order Catalog 1654856 for specifications and part numbers

Hand Tool

The crimping section incorporates Straight Action construction for improved reliability as with automachine.



Part No. :

See the chart above.

Minimum order quantity : 1



Mini-Applicator

Part Number : Contact Technical Support

Minimum order quantity : 1

D-2000 Series (Continued)

D-2100S

Appearance Board mounting pitch: 2.5mm
 Dielectric Withstanding Voltage: 1,500V (for one minute)
 Voltage Rating: 250 VAC

D-2000 Series

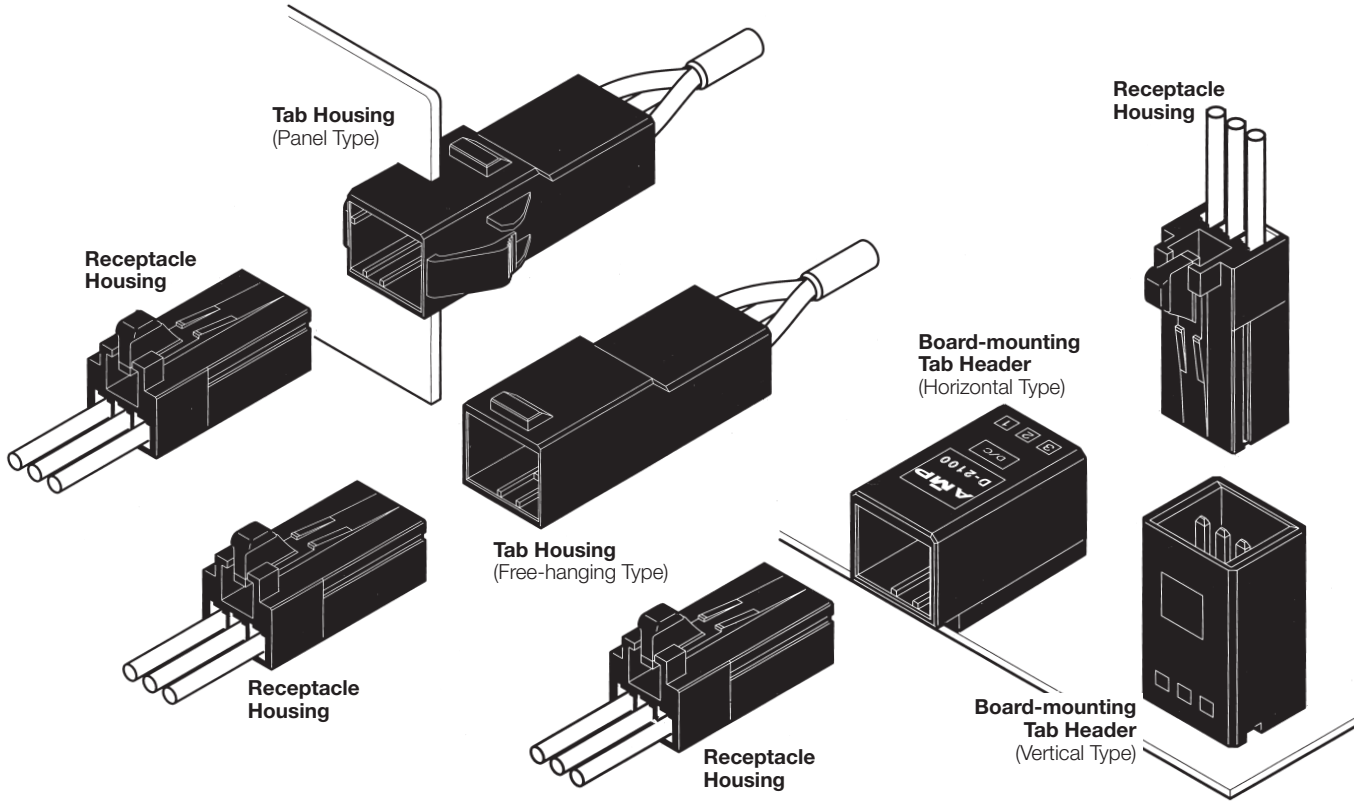

Receptacle Housing

Tab Housing

Board-mounting Tab Header

(Panel Type)

(Free-hanging Type)

(Horizontal Type)

(Vertical Type)

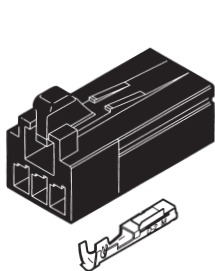

Receptacle Contact

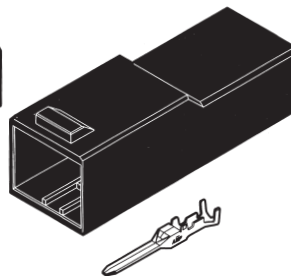
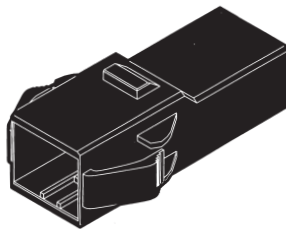

Tab Contact.....For each line of contacts, refer to the appropriate pages.

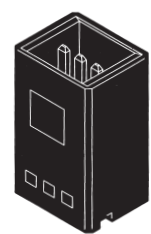
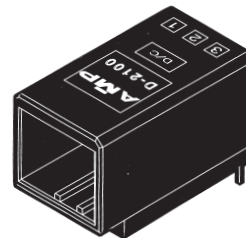

No. of Pos.	Keying	Receptacle Housing	Tab Housing		Board-mounting Tab Header	
			Panel Type	Free-hanging Type	Horizontal Type	Vertical Type
3	X	1-1318120-3	1-1318116-3	1-1318117-3	1376135-1	1318123-1
	Y	2-1318120-3	2-1318116-3	2-1318117-3	1376135-2	1318123-2
	X	1-1473074-3*	—	—	—	—

*Drawer Type

D-2000 Series (Continued)

D-2100S (Continued)

Keying

Keying is provided with this product (D-2100S) for use in helping prevent misinsertion.

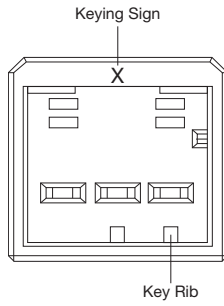

X-Type

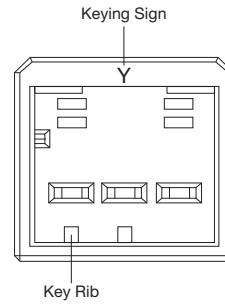

Y-Type

D-2000 Series (Continued)

D-2100S (Continued)

Mating Dimensions

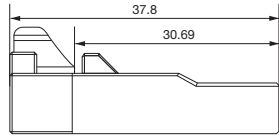

Panel / Free-hanging Type

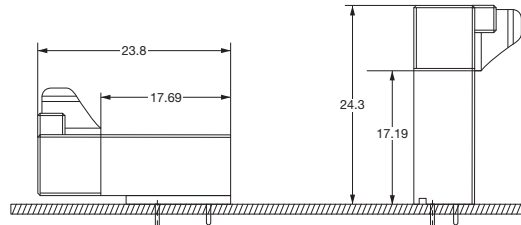

Horizontal Type

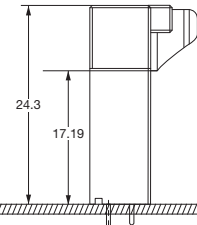

Vertical Type

External Dimensions

Receptacle Housing

Mating Tab Connector
Part Number:

- 1318116-□
- 1318117-□
- 1318123-□
- 1376135-□

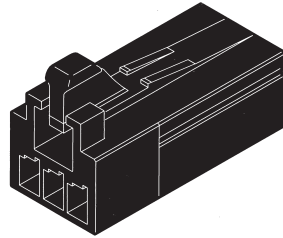

No. of Pos.	Part Number of Receptacle Housing	Dimensions	
		A	B
3	□-1318120-3	8.3	8.9
	1-1473074-3*	—	11.8

□ is for the following key codes: 1- (X-Type), 2- (Y-Type)
*Drawer Type

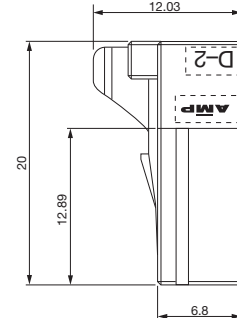
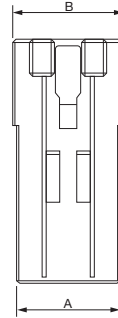
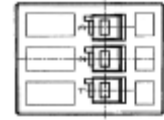
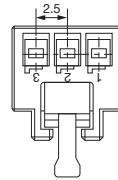

Drawer Type

Tab Housing

Mating Receptacle Housing

Part Number:
□-1318120-□
1-1473074-3

Panel Type

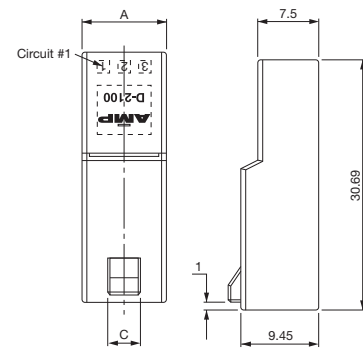
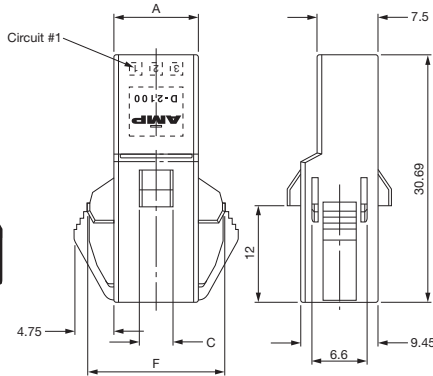
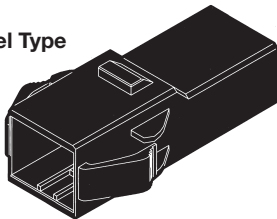

Free-Hanging Type

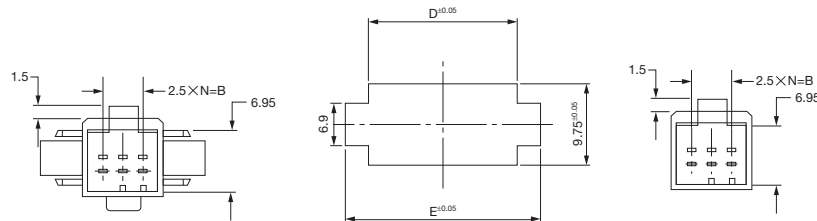
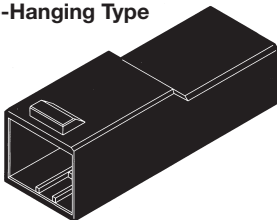

Panel Cutout

No. of Pos.	Part Number of Tab Housing		Dimensions					
	Panel Type	Free-hanging Type	A	B	C	D**	E**	F**
3	□-1318116-3	□-1318117-3	10.2	5	4	10.5	16.5	16.38

**Applies only for panel type. □ is for the following key codes: 1- (X-Type), 2- (Y-Type)

D-2000 Series (Continued)

D-2100S (Continued)

Board-mounting Tab Header
(Vertical Type)

Mating Receptacle Housing
Part Number:
□-1318120-□
1-1473074-3

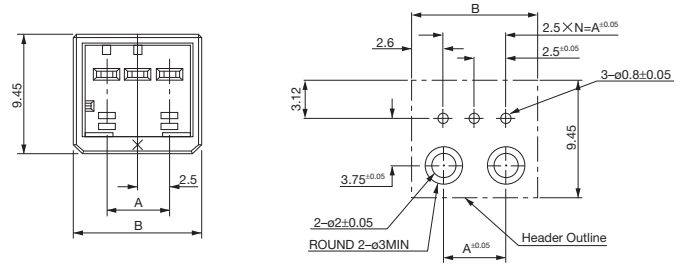
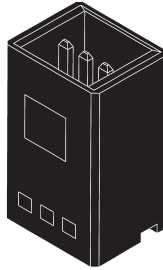

PC Board Layout
Acceptable Board Thickness :
1.6±0.3

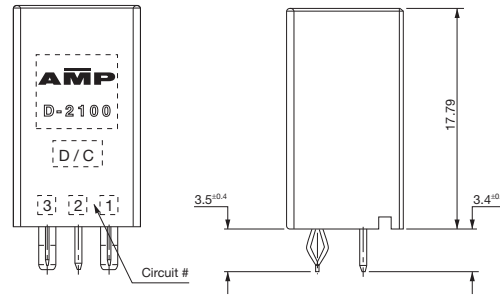

No. of Pos.	Part Number	Dimensions	
		A	B
3	1318123-□	5	10.2

□ is for the following key codes: -1 (X-Type), -2 (Y-Type)

Board-mounting Tab Header
(Horizontal Type)

Mating Receptacle Housing
Part Number:
□-1318120-□
1-1473074-3

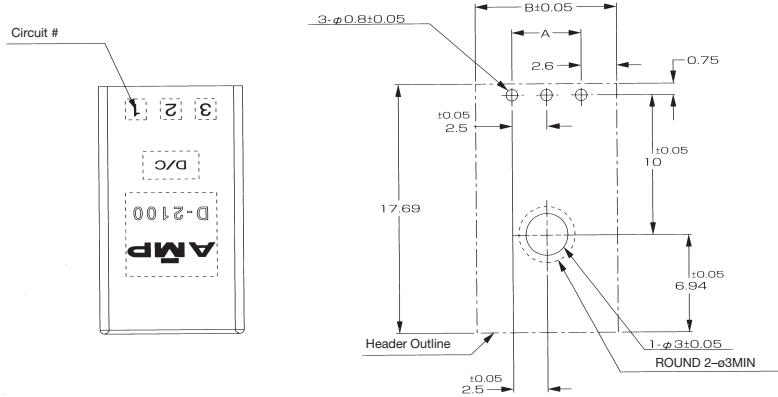
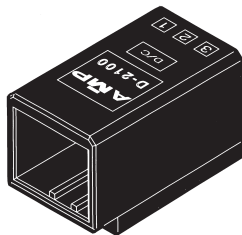

PC Board Layout
Acceptable Board Thickness :
1.6±0.3

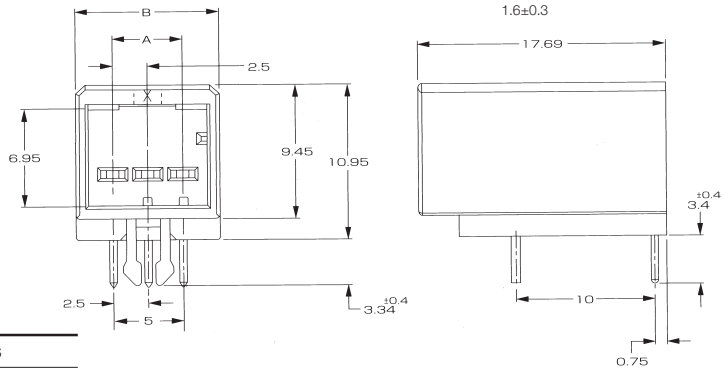

No. of Pos.	Part Number	Dimensions	
		A	B
3	1376135-□	5	10.2

□ is for the following key codes: -1 (X-Type), -2 (Y-Type)

D-2000 Series (Continued)

D-2100D

Appearance Board mounting pitch: 2.5mm
 Dielectric Withstanding Voltage: 1,500V (for one minute)
 Voltage Rating: 250 VAC

D-2000 Series

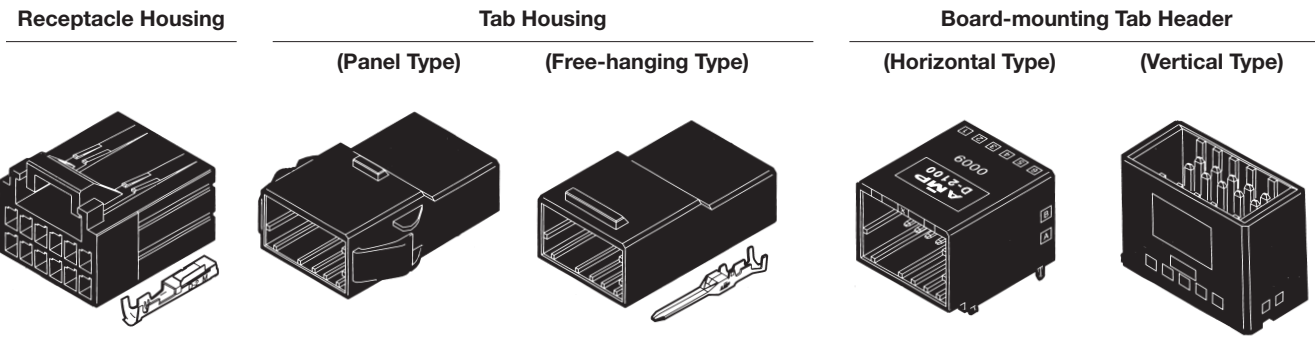
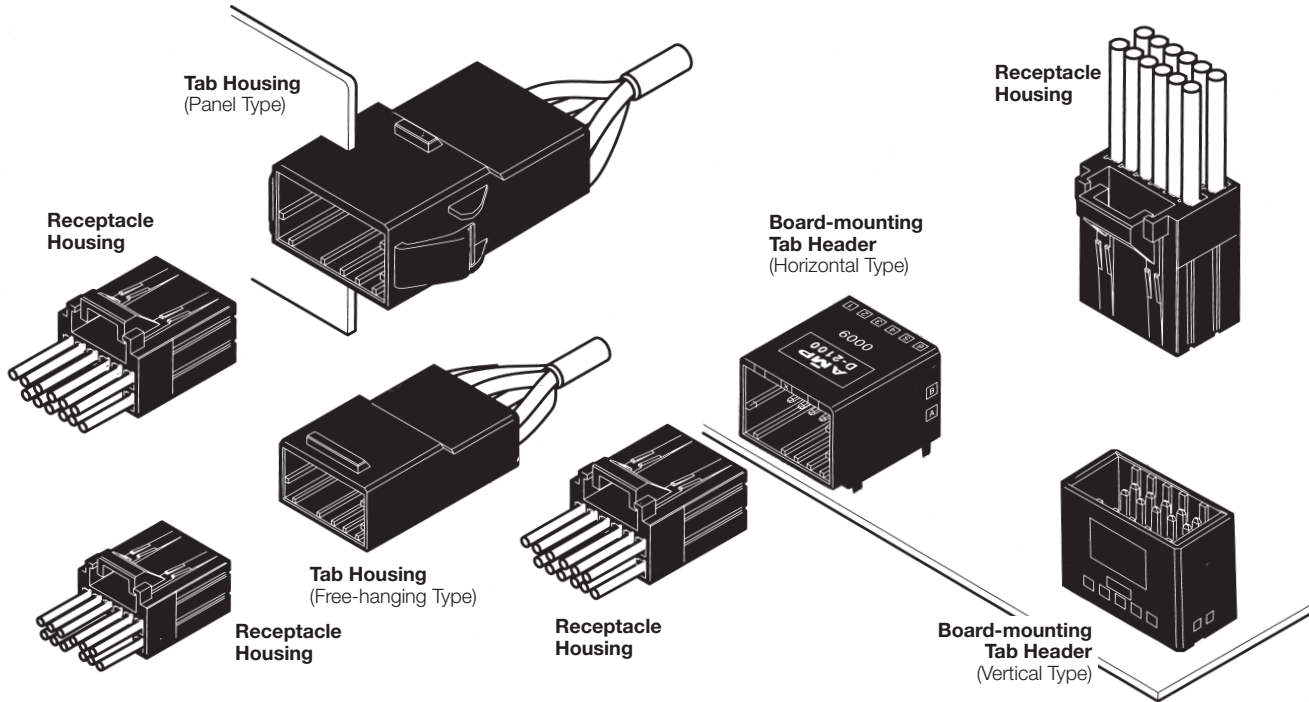

Receptacle Contact

Tab Contact.....For each line of contacts, refer to the appropriate pages.

No. of Pos.	Keying	Part Number of Receptacle Housing	Part Number of Tab Housing		Part Number of Board-mounting Tab Header	
			Panel Type	Free-hanging Type	Horizontal Type	Vertical Type
6	X	1-1318119-3	1-1318114-3	1-1318115-3	1376136-1	1318124-1
	Y	2-1318119-3	2-1318114-3	2-1318115-3	1376136-2	1318124-2
8	X	1-1318119-4	1-1318114-4	1-1318115-4	1376009-1	1318125-1
	Y	2-1318119-4	2-1318114-4	2-1318115-4	1376009-2	1318125-2
12	X	1-1318118-6	1-1318114-6	1-1318115-6	1376020-1	1318126-1
	Y	2-1318118-6	2-1318114-6	2-1318115-6	1376020-2	1318126-2
	Z	3-1318118-6	—	—	—	1318126-3
16	X	1-1318118-8	—	—	—	1747994-1
	Y	2-1318118-8	—	—	—	1747994-2
20	X	1-1318118-9	1-1318114-9	1-1318115-9	1376137-1	1318127-1
	Y	2-1318118-9	2-1318114-9	2-1318115-9	1376137-2	1318127-2

D-2000 Series (Continued)

D-2100D (Continued)

Keying

Keying is provided with this product (D-2100D) for use in helping prevent misinsertion.

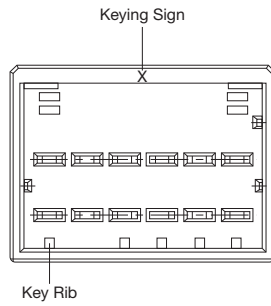

X-Type

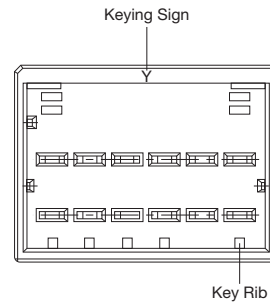

Y-Type

D-2000 Series (Continued)

D-2100D (Continued)

Mating Dimensions

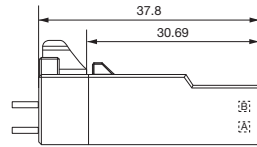

Panel / Free-hanging Type

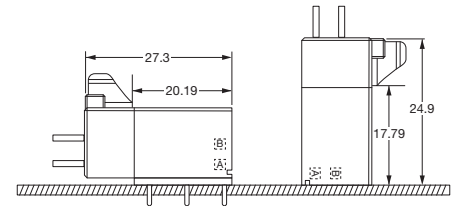

Horizontal Type

Vertical Type

External Dimensions

Receptacle Housing

Mating Tab Connector

Part Number:

- 1318114-□ □-1376136-□
- 1318115-□ □-1376009-□
- 1318124-□ □-1376020-□
- 1318125-□ □-1376137-□
- 1318126-□ □-1747994-□
- 1318127-□

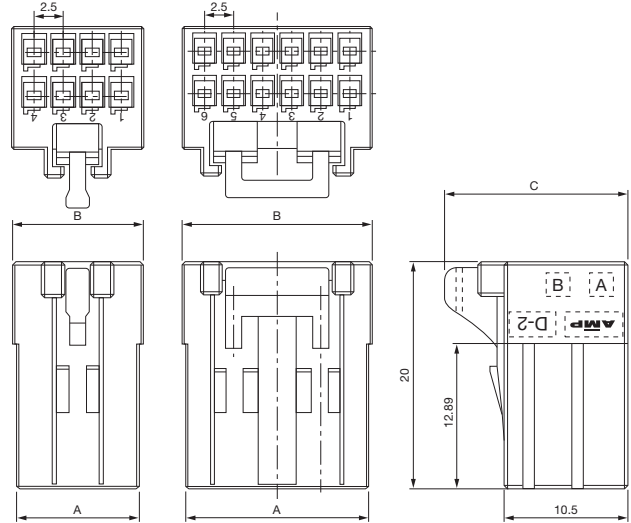
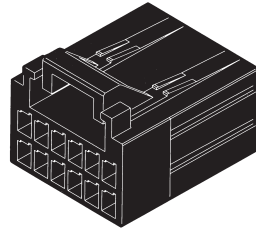

No. of Pos.	Part Number of Receptacle Housing	Dimensions		
		A	B	C
6	□-1318119-3	8.3	8.9	15.8
8	□-1318119-4	10.8	11.4	15.8
12	□-1318118-6	15.8	16.4	14.8
16	□-1318118-8	20.8	21.4	14.8
20	□-1318118-9	25.8	26.4	14.8

□ is for the following key codes:
1- (X-Type), 2- (Y-Type), 3- (Z-Type - Only 12 position)

Tab Housing

Mating Receptacle Housing

Part Number:

- 1318119-□ □-1318118-□

Panel Type

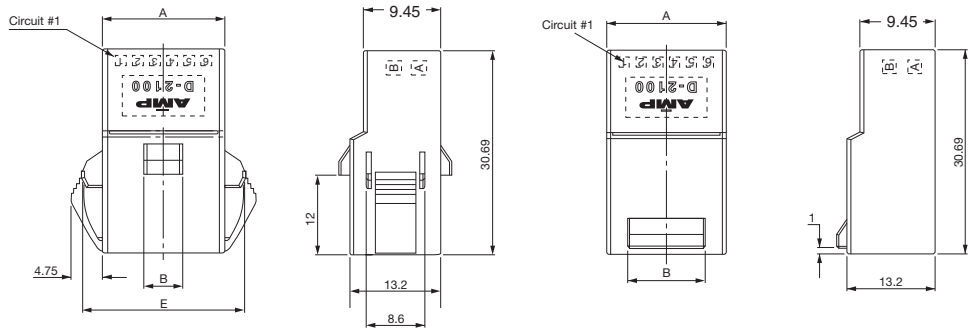
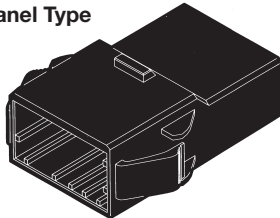

Free-Hanging Type

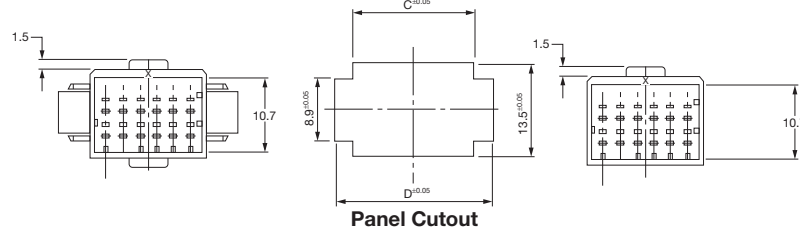
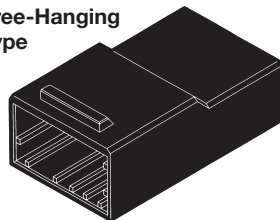

Panel Cutout

No. of Pos.	Part Number of Tab Housing		Dimensions				
	Panel Type	Free-hanging Type	A	B	C**	D**	E**
6	□-1318114-3	□-1318115-3	10.2	4	10.5	16.5	16.38
8	□-1318114-4	□-1318115-4	12.7	4	13	19.0	18.88
12	□-1318114-6	□-1318115-6	17.7	11.5*	18	24.0	23.88
20	□-1318114-9	□-1318115-9	27.7	11.5*	28	34.0	33.88

**Applies only for panel type. *The dimension "B" for panel type is 6.0mm.

□ is for the following key codes: 1- (X-Type), 2- (Y-Type)

D-2000 Series (Continued)

D-2100D (Continued)

Board-mounting Tab Header (Vertical Type)

Mating Receptacle Housing

Part Number:

□-1318119-□

□-1318118-□

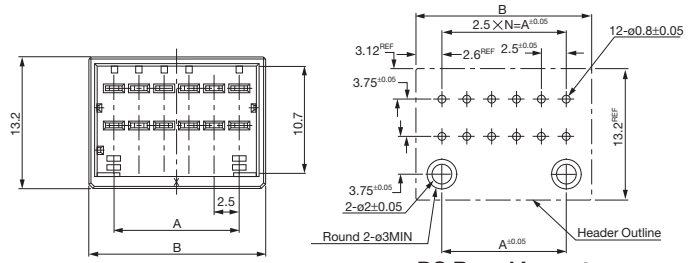
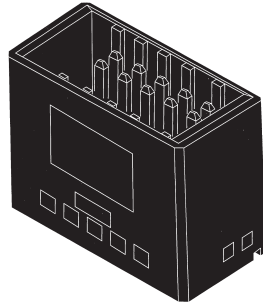

PC Board Layout
Acceptable Board Thickness : 1.6±0.3

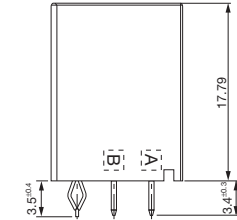
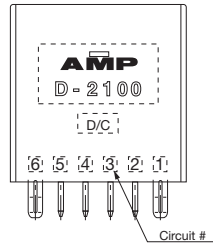

No. of Pos.	Part Number	Dimensions	
		A	B
6	1318124-□	5	10.2
8	1318125-□	7.5	12.7
12	1318126-□	12.5	17.7
16	1747994-□	17.5	22.7
20	1318127-□	22.5	27.7

□ is for the following key codes:
-1 (X-type), -2 (Y-type)

Board-mounting Tab Header (Horizontal Type)

Mating Receptacle Housing

Part Number:

□-1318119-□

□-1318118-□

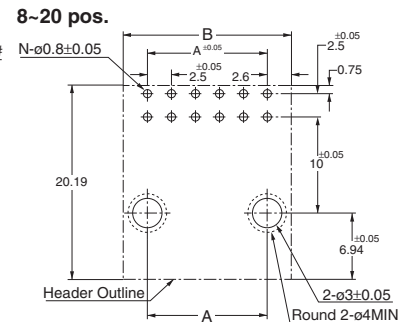
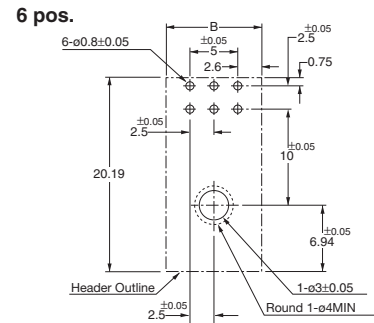
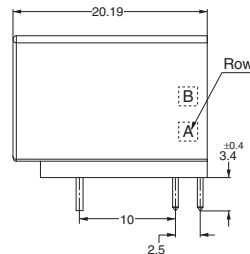
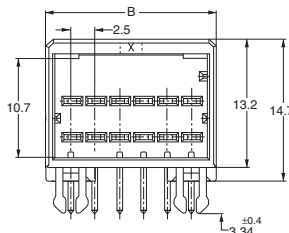
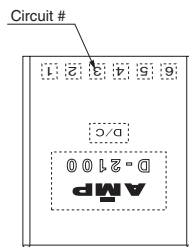
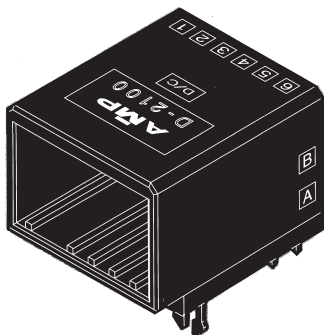

PC Board Layout
Acceptable Board Thickness : 1.6±0.3

No. of Pos.	Part Number	Dimensions	
		A	B
6	1376136-□	—	10.2
8	1376009-□	7.5	12.7
12	1376020-□	12.5	17.7
20	1376137-□	22.5	27.7

□ is for the following key codes:
-1 (X-type), -2 (Y-type)

D-2000 Series (Continued)

D-2100M Drawer Type

Appearance

Board mounting pitch : 2.5mm
Dielectric Withstanding Voltage : 2.3kV (wire-to-wire type), 1.5kV (wire-to-board type)
Current rating : 2.6A (with 20 AWG, 50 pos.)

Application 1

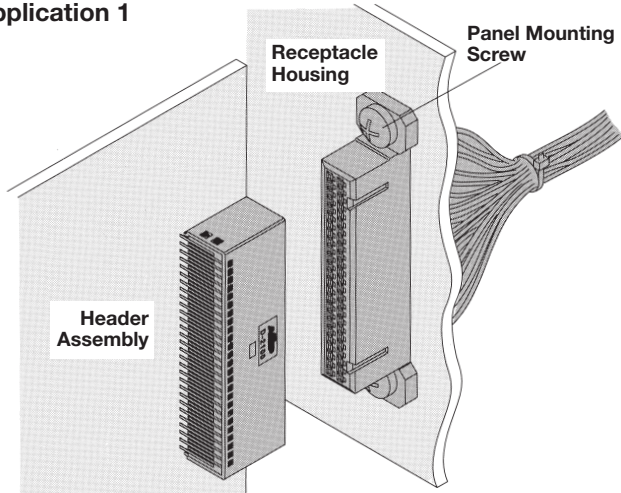

Suitable for an application where the receptacle side is drawer-able and the tab side is fixed.

*The receptacle housing is fixed on the panel with fixed screws.

	Part Number
Receptacle Housing (50 Pos.)	1318577-1
Panel Mounting Screw	900167-1
Header Assembly (50 Pos.)	1318579-1

Application 2

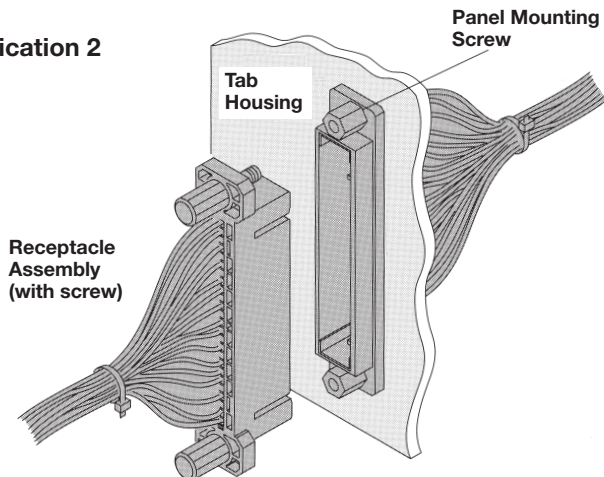

The tab housing is fixed on the panel. The receptacle assembly is mated by turnable jackscrews. Can be used as a wire-to-wire connector with a panel or a bulkhead.

	Part Number
Receptacle Assembly (with screw) (50 Pos.)	1376072-2
Panel Mounting Screw	1376059-1
Tab Housing (50 Pos.)	1318578-2

Application 3

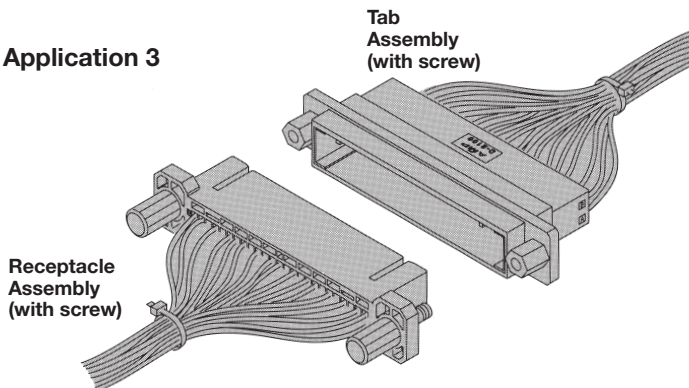

Can be used as a wire-to-wire connector. The tab and receptacle assemblies are mated with two jackscrews on both sides.

	Part Number
Receptacle Assembly (with screw) (50 Pos.)	1376072-2
Tab Assembly (with screw) (50 Pos.)	1376073-2

D-2000 Series

Product Specification: 108-5659

D-2000 Series (Continued)

D-2100M Drawer Type
(Continued)

Mating Dimensions

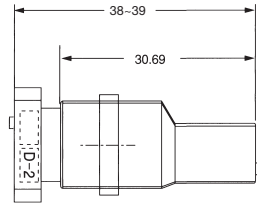

Panel/Free-Hanging Type

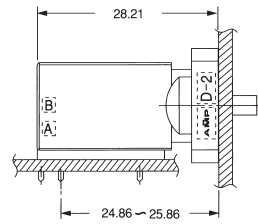

Drawer Type

External Dimensions

Receptacle Housing

Mating Header Assembly
Part Number:
1318579-1

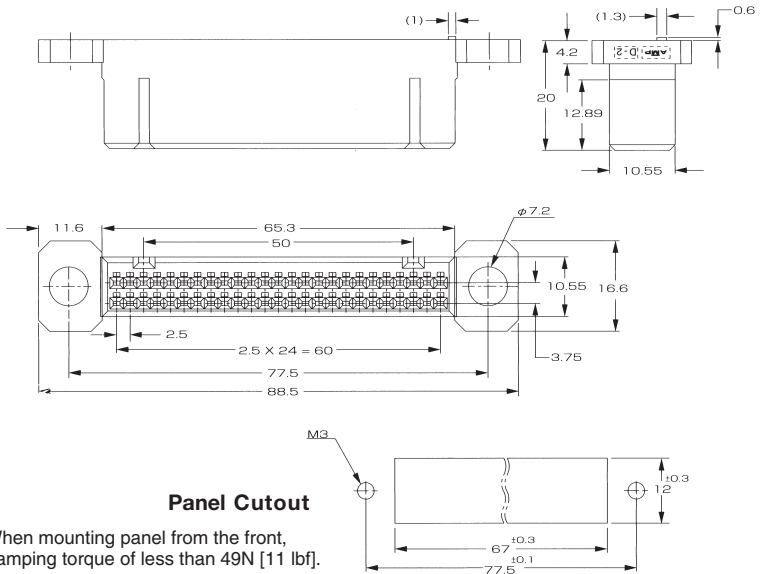
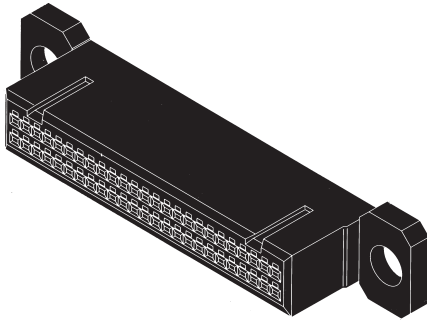

Panel Cutout

Note: When mounting panel from the front, apply clamping torque of less than 49N [11 lbf].

No. of Pos.	Part Number
50	1318577-1

Tab Housing

Mating Receptacle Assembly
Part Number:
1376072-2

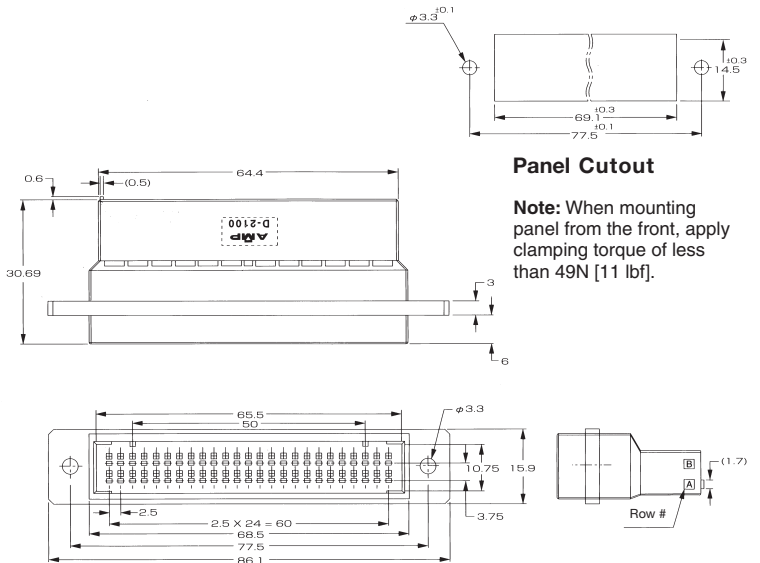
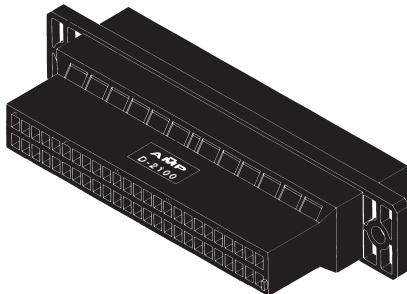

Panel Cutout

Note: When mounting panel from the front, apply clamping torque of less than 49N [11 lbf].

No. of Pos.	Part Number
50	1318578-2

D-2000 Series (Continued)

D-2000 Series

D-2100M Drawer Type

(Continued)

**Board-Mount Tab Header
(Horizontal Type)**

Mating Receptacle Housing

Part Number:

1318557-1

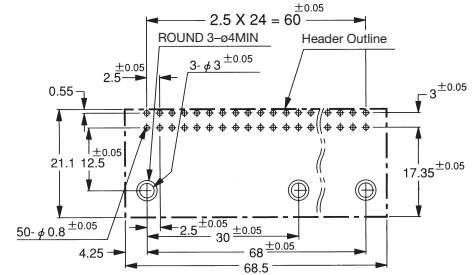
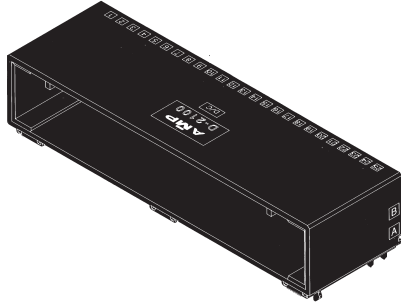

PC Board Layout

Applicable Board Thickness :
1.6±0.4

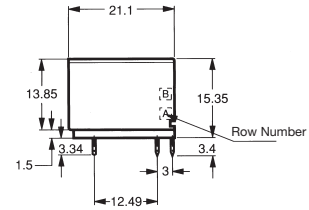
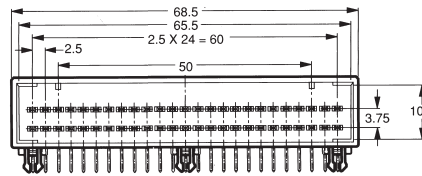

No. of Pos.	Part Number
50	1318579-1

Panel Mounting Screw

Part Number
900167-1

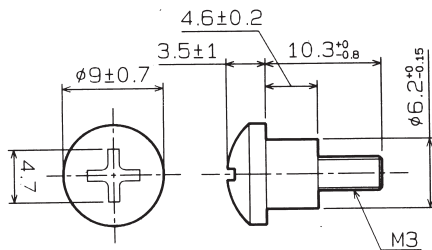
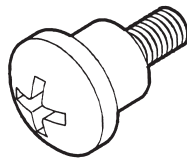

Panel Mounting Screw

Part Number
1376059-1

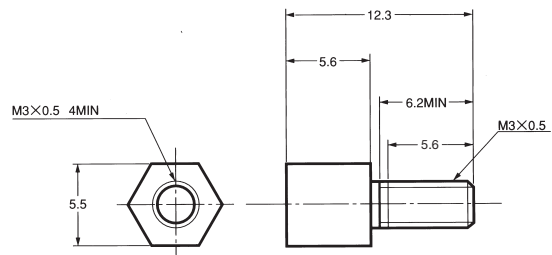
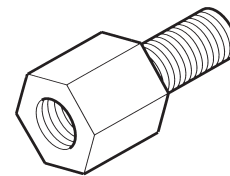

D-2000 Series (Continued)

D-2100M Screw Lock Type

**Receptacle Assembly
(with screw)**

Mating Tab Assembly
Part Number:
1318578-2
1376073-2

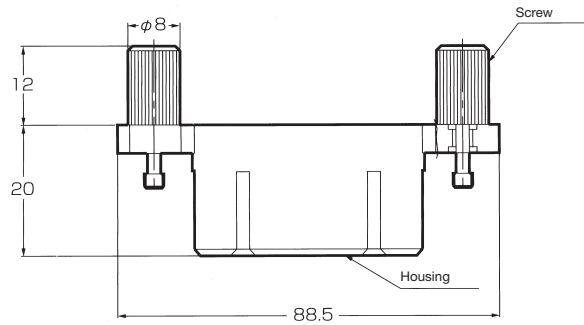
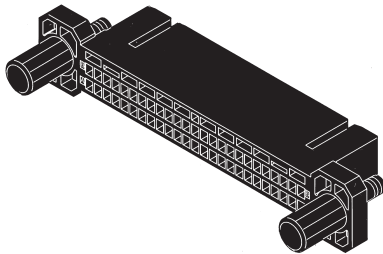

No. of Pos.	Part Number
50	1376072-2

**Tab Assembly
(with screw)**

Mating Receptacle Assembly
Part Number:
1376072-2

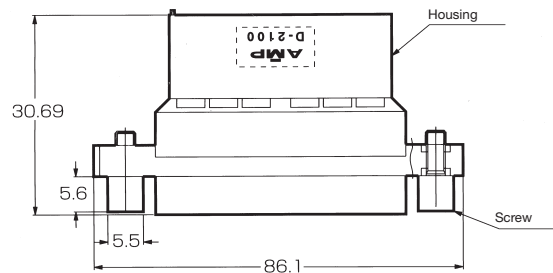
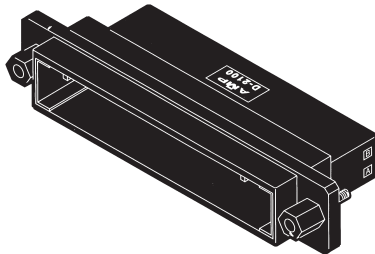

No. of Pos.	Part Number
50	1376073-2

D-2000 Series (Continued)

D-2600 Series



D-2600 Series Connectors combine power and signal lines, which can dramatically improve productivity by reducing assembly steps.

Power lines (15A*/contact) and signal lines (5A*/contact) with different size contacts are combined in the Dynamic 2600 Series. Along

with being able to mate different size wires at one time, it contributes to more compact sizes and fewer assembly steps, and it also makes maintenance more efficient. On top of that, the contact has complete compatibility with the Dynamic D-2000 and D-3000 Series so new components and

applicators are not needed, eliminating the need for new equipment costs. Low mating force and mating/unmating and contact reliability continue to be superior to provide easy handling.

*The current ratings noted above are for 1 contact. The current rating is derated depending on the number of contacts.

Performance Characteristics

Pitch — D-2: 2.5 mm / -3: 3.81 mm

Voltage Rating — 250 VAC

Current Rating — D-2: 3.2 A;
D-3: 7.5 A

Contact Resistance — 10 mΩ Max.

Dielectric Withstanding Voltage —
1500 V 1 minute

Operating Temperature —
-55°C to +105°C

*When connectors are used singly.

Material and Finish

Receptacle Contact — Copper alloy, gold plated over 1.27 μm nickel underplate

PCB Tab Post — Copper alloy, 0.38 μm gold plated over 1.27 μm nickel underplate, Tab post tin plated

Housing — Glass Filled Polyester (PBT), UL 94V-0

Technical Documents

Product Specification
108-78301

Application Specification
114-5258
114-5148

D-2 Contact (Refer to page 19)

D-3 Contact (Refer to page 38)

D-2000 Series (Continued)

D-2600 Series (Continued)

Mating Dimensions

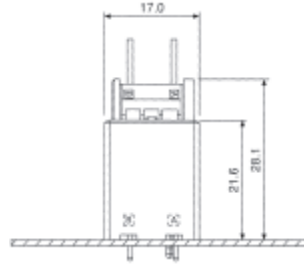

Vertical Type

Dimensions

Receptacle Housing

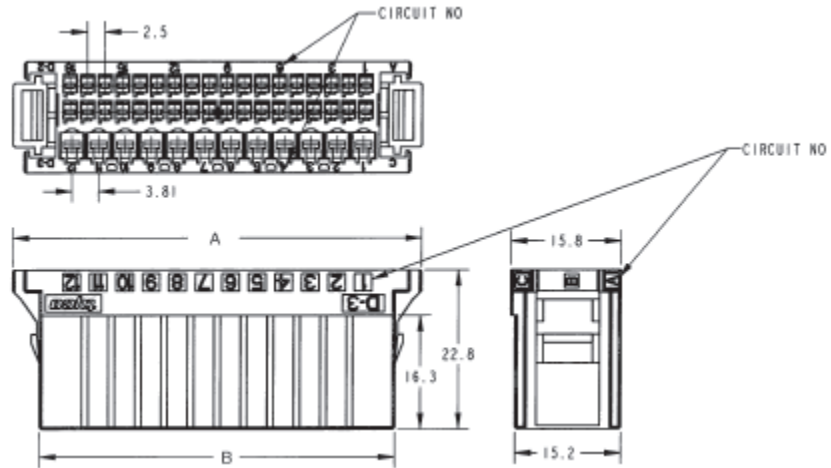

No. of Pos.	Part Number	Dimensions	
		A	B
48	1827540-1	58.65	51.0

Board Mount Tab Header (Vertical Type)

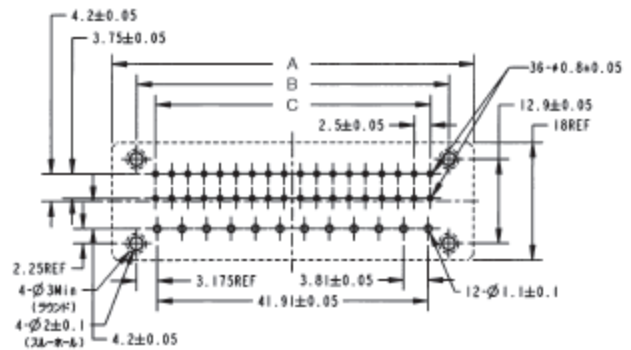
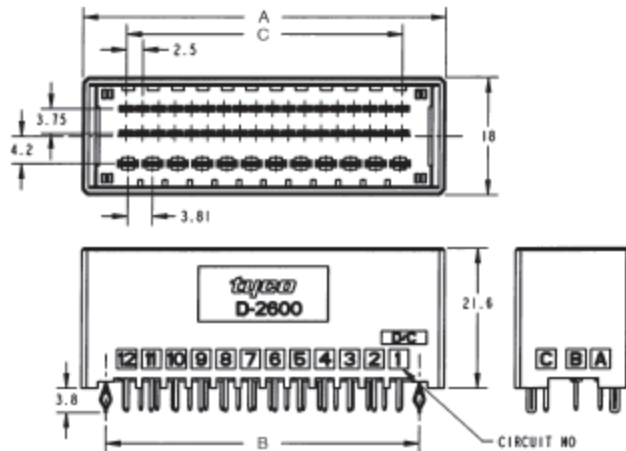

PC Board Layout

Acceptable Board Thickness : 1.0-1.6±0.1

No. of Pos.	Part Number	Dimensions		
		A	B	C
48	1827538-1	55.91	48.26	42.50