



120×120×38 mm

San Ace 120W 9WG type

DC
Splash Proof Fan 120 mm sq.

General Specifications

- Material Frame: Aluminum (Black coating), Impeller: Plastic (Flammability: UL 94V-1)
- Expected life See the table below. (L10 life: 90% survival rate for continuous operation in indoor free air at 60°C, rated voltage)
Expected life at 40°C is for reference only.
- Motor protection function Locked rotor burnout protection, Reverse polarity protection
For details, please refer to p. 573.
- Dielectric strength 50/60 Hz, 500 VAC, for 1 minute (between lead wire conductors and frame)
- Insulation resistance 10 MΩ or more with a 500 VDC megger (between lead wire conductors and frame)
- Sound pressure level (SPL) At 1 m away from the air inlet
- Storage temperature -30 to +70°C (Non-condensing)
- Lead wire ⊕Red ⊖Black or Blue Sensor Yellow
- Mass 410 g
- Ingress protection IP55

Specifications

The models listed below **have pulse sensors**.

| Model no. | Rated voltage [V] | Operating voltage range [V] | Rated current [A] | Rated input [W] | Rated speed [min ⁻¹] | Max. airflow [m ³ /min] [CFM] | Max. static pressure [Pa] [inchH ₂ O] | SPL [dB (A)] | Operating temperature [°C] | Expected life [h] | |
|---------------|-------------------|-----------------------------|-------------------|-----------------|----------------------------------|--|--|--------------|----------------------------|------------------------------|------------------------------|
| 9WG1212G101-E | 12 | 10.2 to 13.8 | 0.98 | 11.76 | 3600 | 3.88 137 | 135 0.542 | 49 | -20 to +70 | 80000/60°C (115000/40°C) | |
| 9WG1212E101-E | | | 0.61 | 7.32 | 3100 | 3.34 118 | 100 0.402 | 46 | | | |
| 9WG1212H101-E | | 7 to 13.8 | 0.38 | 4.56 | 2600 | 2.8 99 | 70.4 0.283 | 39 | | 100000/60°C (135000/40°C) | |
| 9WG1212F101-E | | | 0.28 | 3.36 | 2280 | 2.45 87 | 54.2 0.218 | 36 | | | |
| 9WG1212M101-E | | | 0.21 | 2.52 | 1950 | 2.1 74 | 39.6 0.159 | 32 | | | |
| 9WG1224G101-E | 24 | 20.4 to 27.6 | 0.5 | 12 | 3600 | 3.88 137 | 135 0.542 | 49 | | -20 to +70 | 80000/60°C (115000/40°C) |
| 9WG1224E101-E | | | 0.34 | 8.16 | 3100 | 3.34 118 | 100 0.402 | 46 | | | |
| 9WG1224H101-E | | 14 to 27.6 | 0.22 | 5.28 | 2600 | 2.8 99 | 70.4 0.283 | 39 | | | 100000/60°C (135000/40°C) |
| 9WG1224F101-E | | | 0.16 | 3.84 | 2280 | 2.45 87 | 54.2 0.218 | 36 | | | |
| 9WG1224M101-E | | | 0.11 | 2.64 | 1950 | 2.1 74 | 39.6 0.159 | 32 | | | |
| 9WG1248G101-E | 48 | 40.8 to 55.2 | 0.25 | 12 | 3600 | 3.88 137 | 135 0.542 | 49 | -20 to +70 | | 80000/60°C (115000/40°C) |
| 9WG1248E101-E | | | 0.17 | 8.16 | 3100 | 3.34 118 | 100 0.402 | 46 | | | |
| 9WG1248H101-E | | | 0.11 | 5.28 | 2600 | 2.8 99 | 70.4 0.283 | 39 | | | 100000/60°C (135000/40°C) |
| 9WG1248F101-E | | | 0.09 | 4.32 | 2280 | 2.45 87 | 54.2 0.218 | 36 | | | |
| 9WG1248M101-E | | | 0.07 | 3.36 | 1950 | 2.1 74 | 39.6 0.159 | 32 | | | |

The following sensor and control options are available for selection.

Available for all models. Without sensor Lock sensor

Airflow - Static Pressure Characteristics

9WG1212G101-E With pulse sensor

Operating voltage range

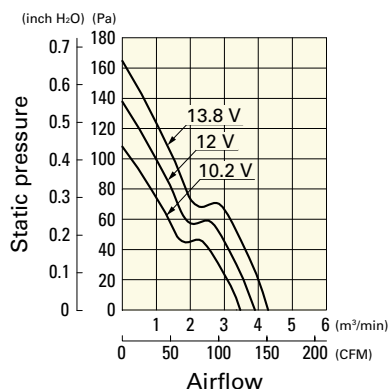

9WG1212E101-E With pulse sensor

Operating voltage range

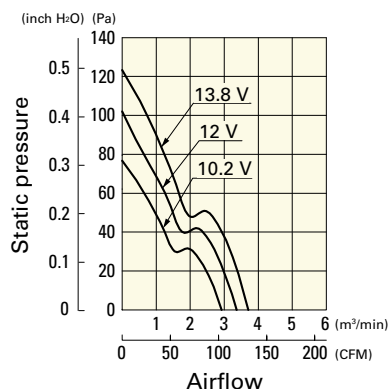

9WG1212H101-E With pulse sensor

Operating voltage range

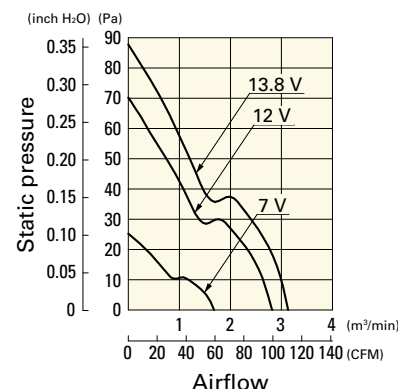

Airflow - Static Pressure Characteristics

9WG1212F101-E With pulse sensor

Operating voltage range

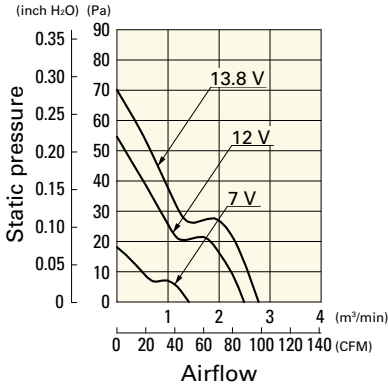

9WG1212M101-E With pulse sensor

Operating voltage range

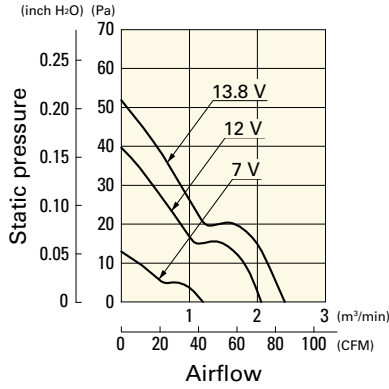

9WG1224G101-E With pulse sensor

Operating voltage range

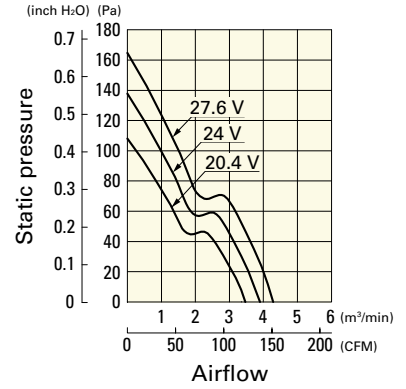

9WG1224E101-E With pulse sensor

Operating voltage range

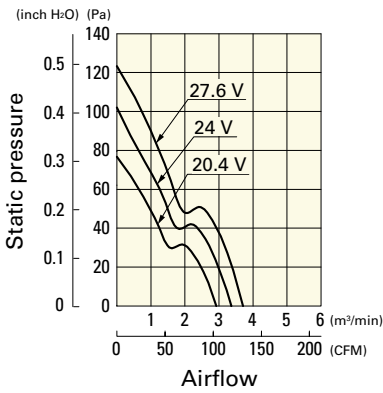

9WG1224H101-E With pulse sensor

Operating voltage range

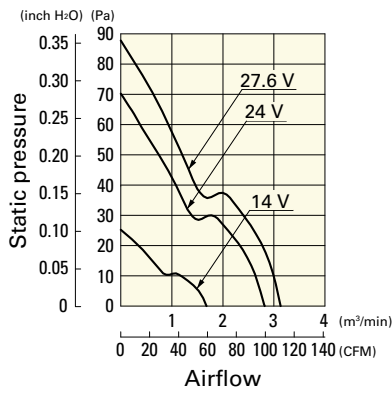

9WG1224F101-E With pulse sensor

Operating voltage range

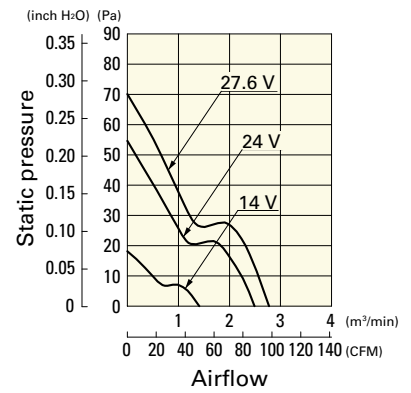

9WG1224M101-E With pulse sensor

Operating voltage range

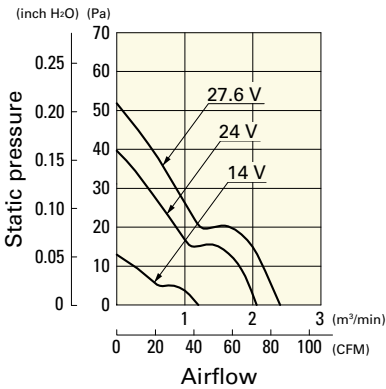

9WG1248G101-E With pulse sensor

Operating voltage range

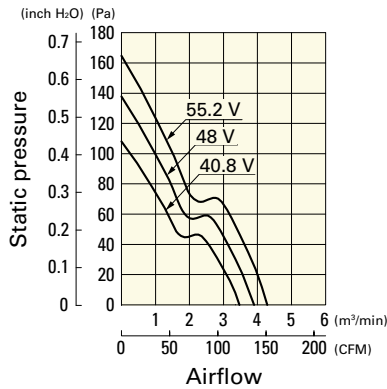

9WG1248E101-E With pulse sensor

Operating voltage range

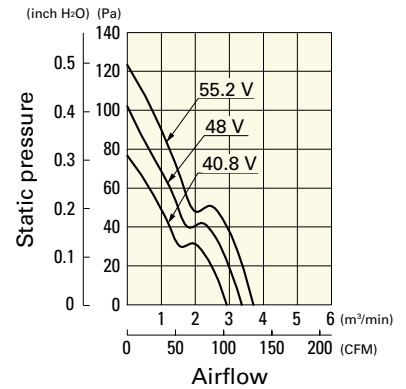

9WG1248H101-E With pulse sensor

Operating voltage range

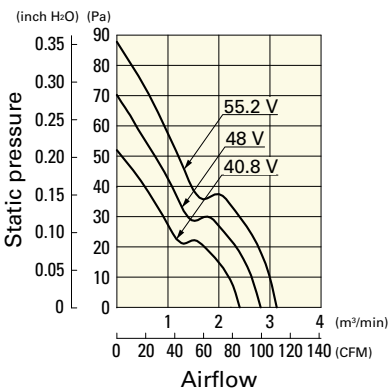

9WG1248F101-E With pulse sensor

Operating voltage range

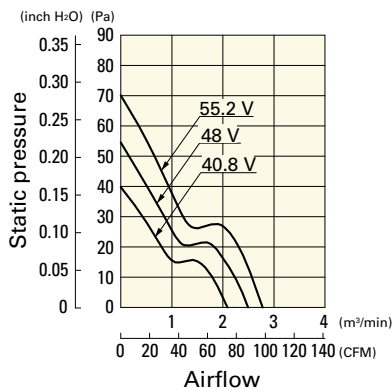

9WG1248M101-E With pulse sensor

Operating voltage range

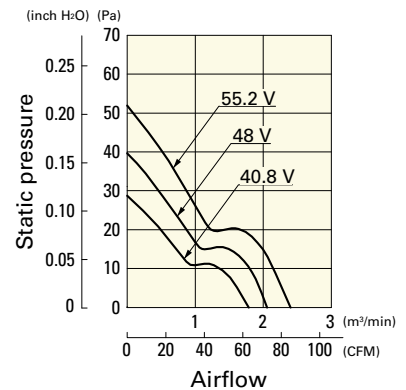

Dimensions (unit: mm)

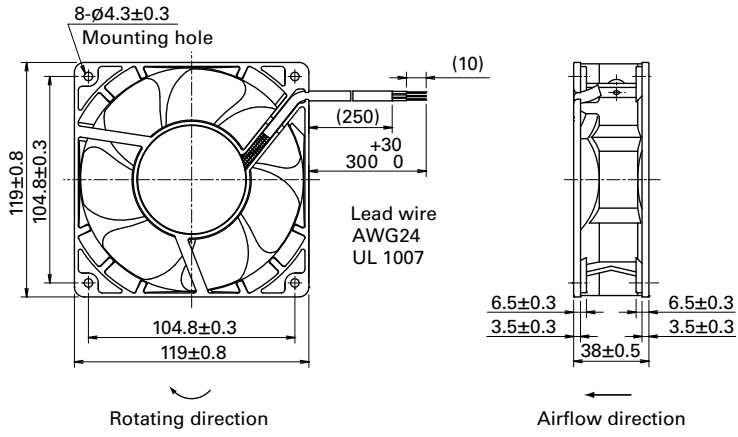

Reference Dimensions of Mounting Holes and Vent Opening (unit: mm)

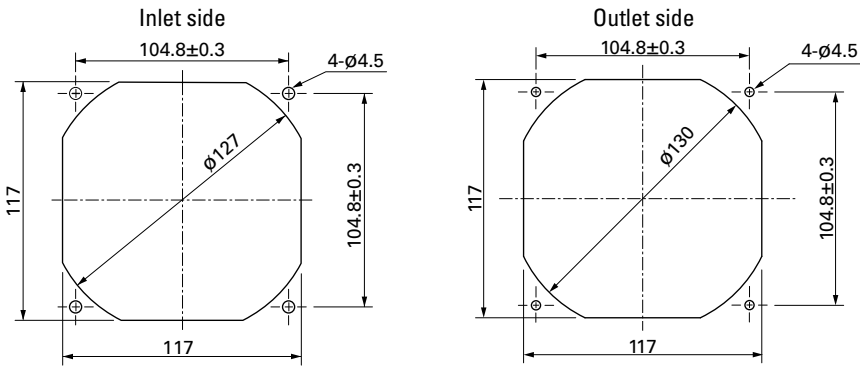

Options

Finger guards

page: p. 559

Model no.: 109-019E, 109-019K, 109-019C, 109-019H

Resin finger guards

page: p. 565

Model no.: 109-1000G