



Features

- Eight channels of EMI filtering
- 30kV ESD protection on each channel (IEC 61000-4-2 Level 4, contact discharge)
- 30kV ESD protection on each channel (HBM)
- Better than 35dB of attenuation at 800-2700MHz
- Chip Scale Package features extremely low lead inductance for optimum filter and ESD performance
- 20-bump, 4.000mm x 1.458mm footprint Chip Scale Package
- *OptiGuard*™ coated version available for improved reliability at assembly
- RoHS-compliant, lead-free finishing

Applications

- LCD data lines in mobile handsets
- EMI filtering & ESD protection for high-speed I/O ports
- EMI filtering for high-speed data lines
- Wireless handsets
- Cell phones
- Notebook computers
- PDAs / Handheld PCs

Product Description

California Micro Device's CM1405 is an EMI filter array with ESD protection, which integrates eight Pi-filters (C-R-C). The CM1405 has component values of 25pF-100W-25pF. The parts include avalanche-type ESD diodes on every pin, which provide a very high level of protection for sensitive electronic components that may be subjected to electrostatic discharge (ESD). The ESD diodes connected to the filter ports safely dissipate ESD strikes of •30kV, exceeding the maximum requirement of the IEC61000-4-2 international standard. Using the MIL-STD-883 (Method 3015) specification for Human Body Model (HBM) ESD, the pins are protected for contact discharges at greater than •30kV.

This device is particularly well-suited for portable electronics (e.g. mobile handsets, PDAs, notebook computers) because of its small package and easy-to-use pin assignments. In particular, the CM1405 is ideal for EMI filtering and protecting data lines from ESD for the LCD display in mobile handsets. The CM1405-03 incorporates *OptiGuard* coating which results in improved reliability at assembly and is available in space-saving, low-profile chip-scale packages with RoHS-compliant, lead-free finishing.

The CM1400-03 incorporates *OptiGuard*™ coating which results in improved reliability at assembly. The CM1400-03 is available in a space-saving, low-profile chip scale package with RoHS compliant lead-free finishing.

Block Diagram

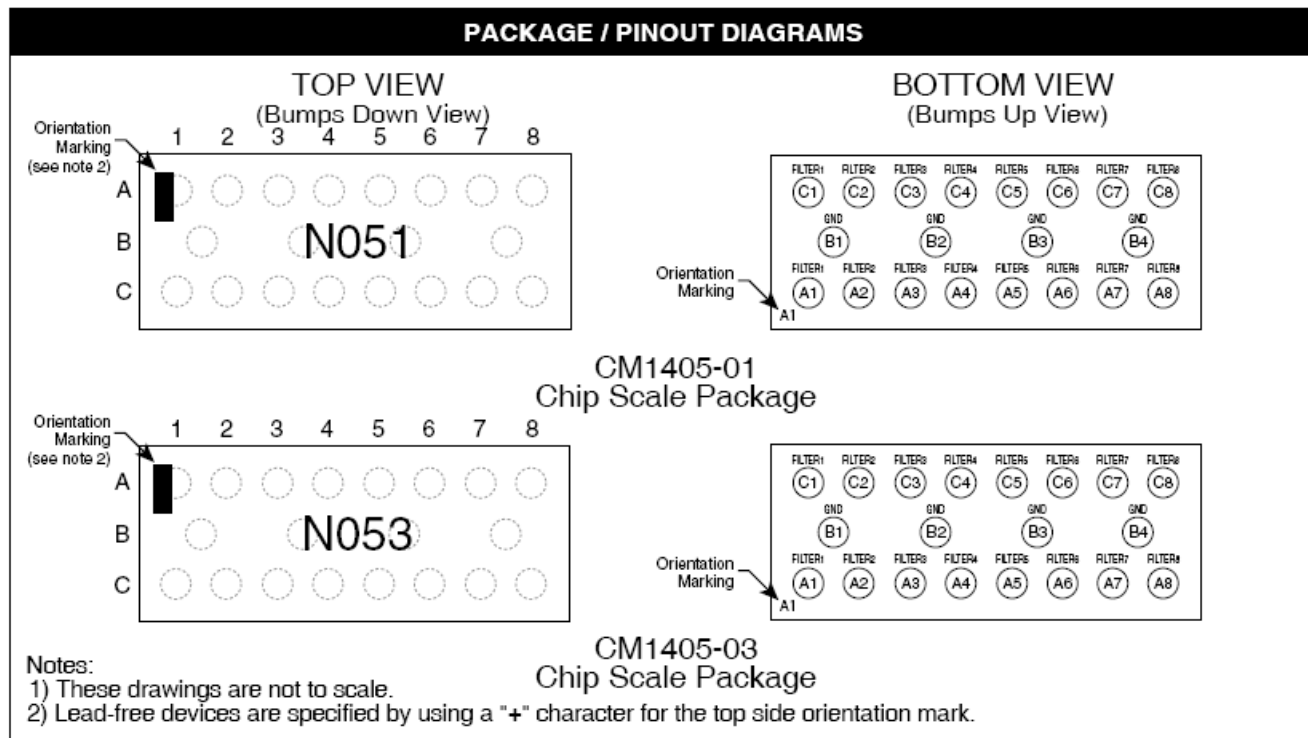
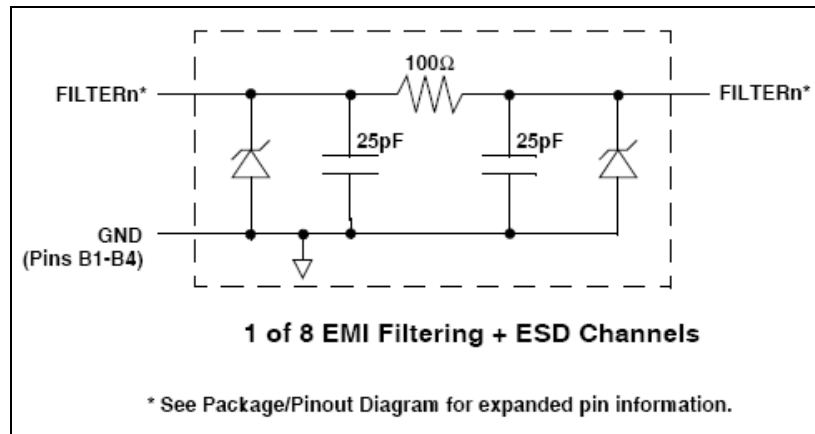

CM1405

PIN DESCRIPTIONS

PIN(s)	NAME	DESCRIPTION	PIN(s)	NAME	DESCRIPTION
A1	FILTER1	Filter Channel 1	C1	FILTER1	Filter Channel 1
A2	FILTER2	Filter Channel 2	C2	FILTER2	Filter Channel 2
A3	FILTER3	Filter Channel 3	C3	FILTER3	Filter Channel 3
A4	FILTER4	Filter Channel 4	C4	FILTER4	Filter Channel 4
A5	FILTER5	Filter Channel 5	C5	FILTER5	Filter Channel 5
A6	FILTER6	Filter Channel 6	C6	FILTER6	Filter Channel 6
A7	FILTER7	Filter Channel 7	C7	FILTER7	Filter Channel 7
A8	FILTER8	Filter Channel 8	C8	FILTER8	Filter Channel 8
B1-B4	GND	Device Ground			

Ordering Information

PART NUMBERING INFORMATION

Bumps	PKG	Standard Finish				Lead-free Finish ²			
		No Coating		Optiguard™ Coated		-No Coating		Optiguard™ Coated	
		Ordering Part Number ¹	Part Marking	Ordering Part Number ¹	Part Marking	Ordering Part Number ¹	Part Marking	Ordering Part Number ¹	Part Marking
20	CSP	CM1405-01CS	N051	CM1405-03CS	N053	CM1405-01CP	N051	CM1405-03CP	N053

Note 1: Parts are shipped in Tape & Reel form unless otherwise specified.

Note 2: Lead-free devices are specified by using a "+" character for the top side orientation mark.

Specifications

ABSOLUTE MAXIMUM RATINGS

PARAMETER	RATING	UNITS
Storage Temperature Range	-65 to +150	°C
DC Power per Resistor	100	mW
DC Package Power Rating	500	mW

STANDARD OPERATING CONDITIONS

PARAMETER	RATING	UNITS
Operating Temperature Range	-40 to +85	°C

ELECTRICAL OPERATING CHARACTERISTICS (SEE NOTE 1)

SYMBOL	PARAMETER	CONDITIONS	MIN	TYP	MAX	UNITS
R	Resistance		80	100	120	Ω
C	Capacitance	At 2.5V DC, 1MHz, 30mV AC	20	25	30	pF
V_{DIODE}	Diode Standoff Voltage	$I_{DIODE} = 10\mu A$		6.0		V
I_{LEAK}	Diode Leakage Current (reverse bias)	$V_{DIODE} = +3.3V$		0.1	1	μA
V_{SIG}	Signal Voltage Positive Clamp Negative Clamp	$I_{LOAD} = 10mA$ $I_{LOAD} = -10mA$	5.6 -1.5	6.8 -0.8	9.0 -0.4	V V
V_{ESD}	In-system ESD Withstand Voltage a) Human Body Model, MIL-STD-883, Method 3015 b) Contact Discharge per IEC 61000-4-2 Level 4	Note 2	30 30			kV kV
R_{DYN}	Dynamic Resistance Positive Negative			1.5 0.9		Ω Ω
f_C	Cut-off Frequency $Z_{SOURCE} = 50\Omega$, $Z_{LOAD} = 50\Omega$	$R = 100\Omega$, $C = 25pF$		70		MHz

Note 1: $T_A = 25^\circ C$ unless otherwise specified.

Note 2: ESD applied to input and output pins with respect to GND, one at a time.

Performance Information

Typical Filter Performance (nominal conditions unless specified otherwise, 50 Ohm Environment)

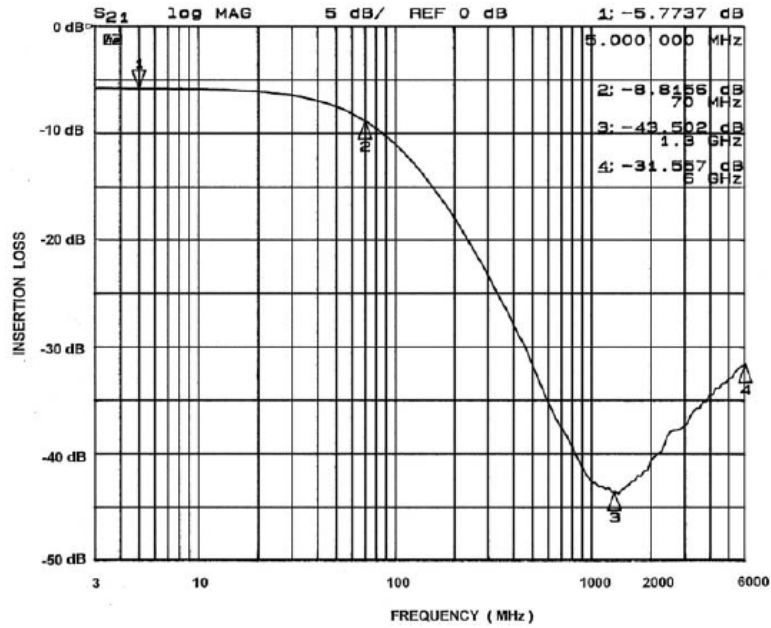

Figure 1. A1-C1 EMI Filter Performance

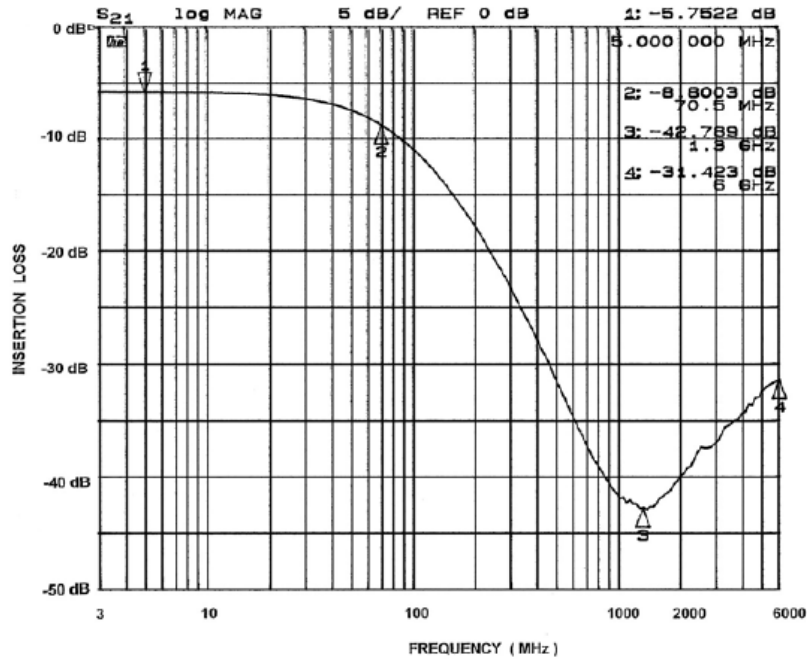

Figure 2. A2-C2 EMI Filter Performance

Performance Information (cont'd)

Typical Filter Performance (nominal conditions unless specified otherwise, 50 Ohm Environment)

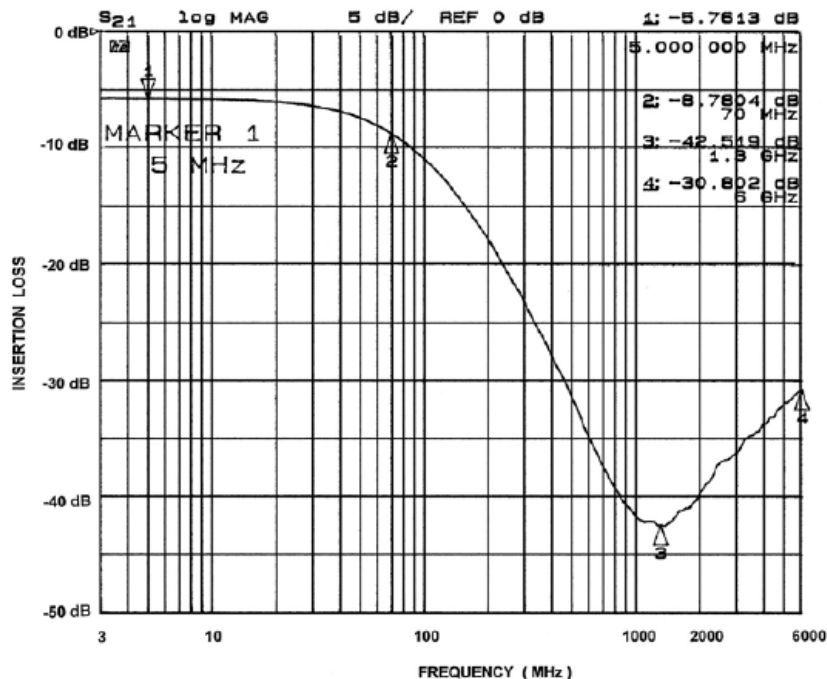

Figure 3. A3-C3 EMI Filter Performance

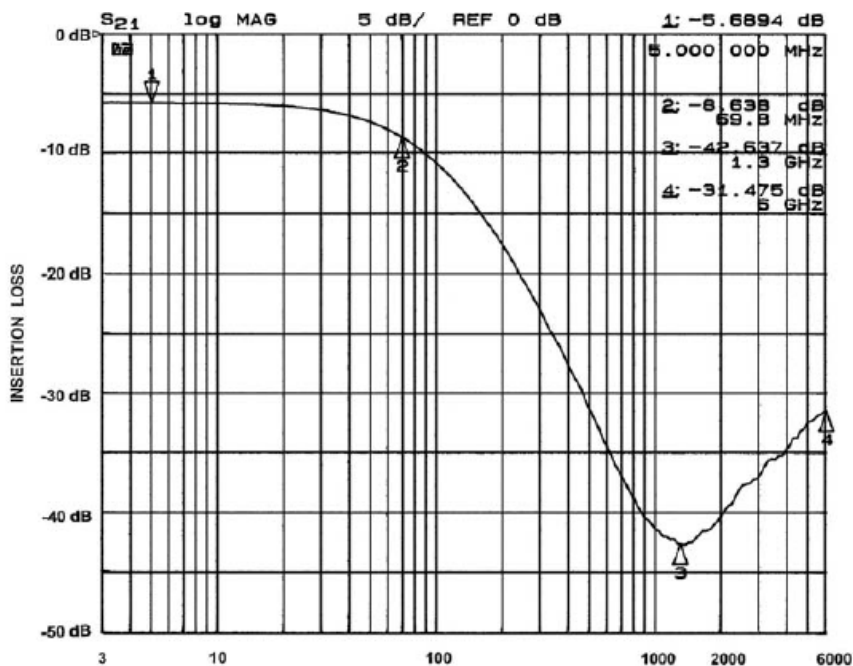

Figure 4. A4-C4 EMI Filter Performance

Performance Information (cont'd)

Typical Filter Performance (nominal conditions unless specified otherwise, 50 Ohm Environment)

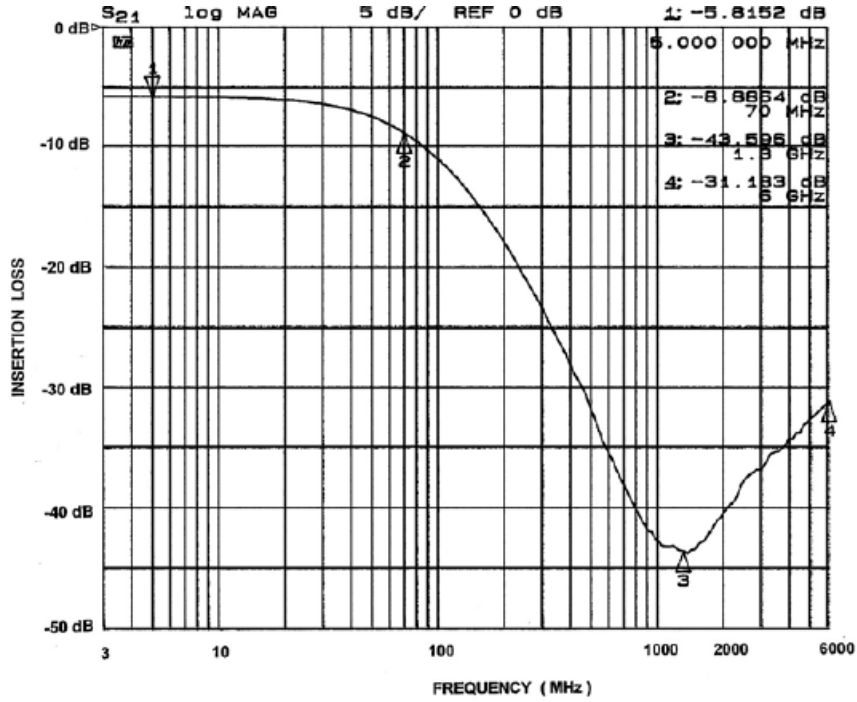

Figure 5. A5-C5 EMI Filter Performance

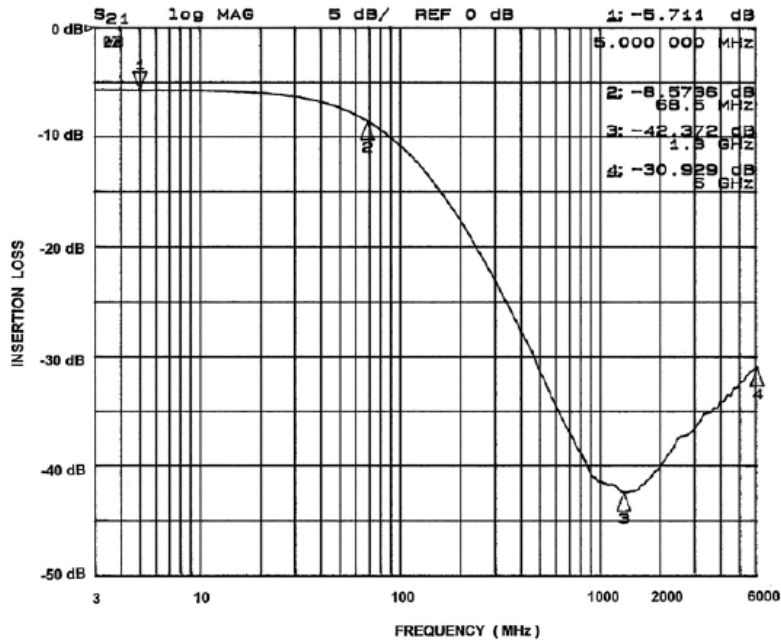

Figure 6. A6-C6 EMI Filter Performance

Performance Information (cont'd)

Typical Filter Performance (nominal conditions unless specified otherwise, 50 Ohm Environment)

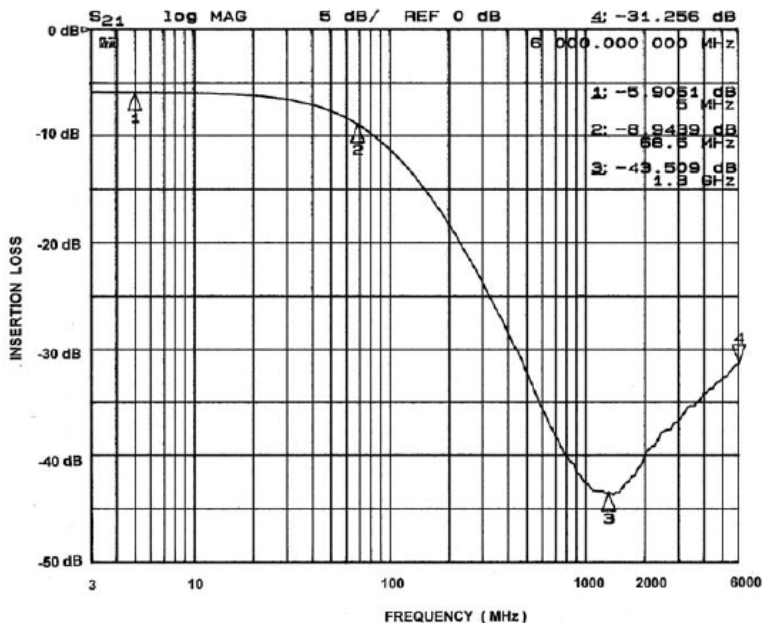

Figure 7. A7-C7 EMI Filter Performance

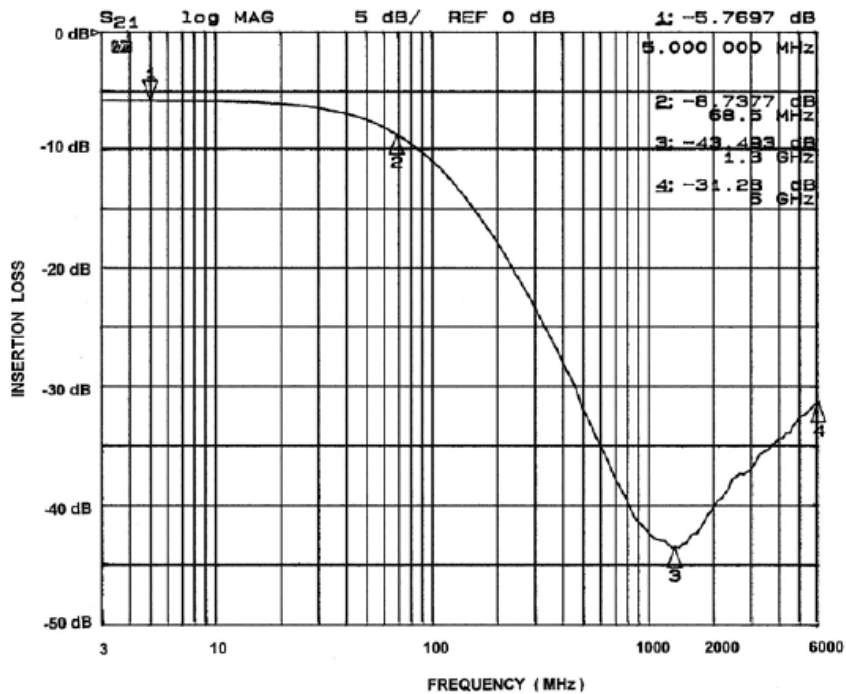

Figure 8. A8-C8 EMI Filter Performance

Performance Information (cont'd)

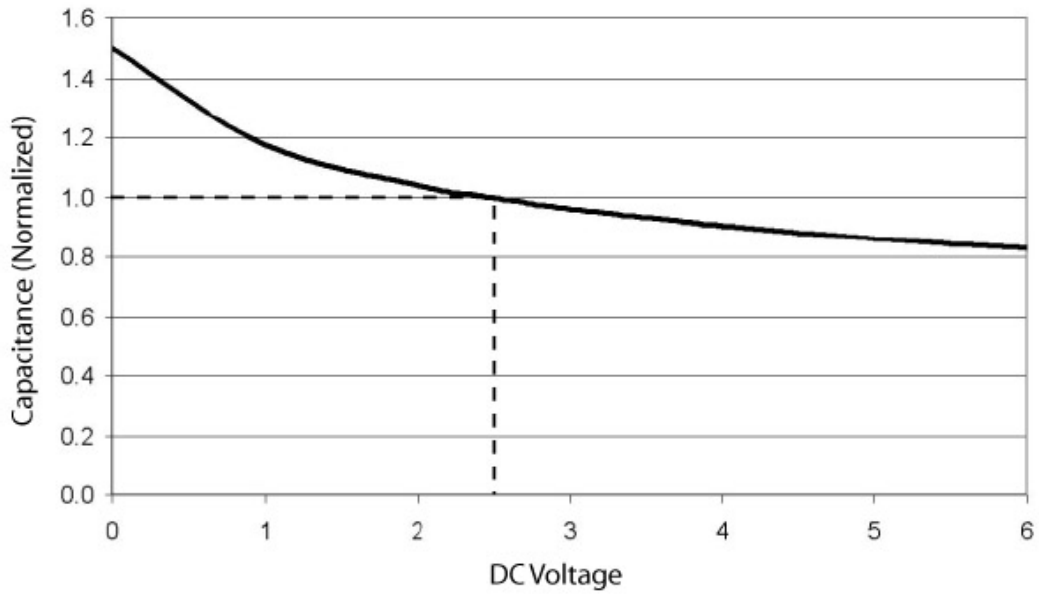

Figure 9. Filter Capacitance vs. Input Voltage over Temperature (normalized to capacitance at 2.5VDC and 25°C)

Figure 9.

Application Information

PARAMETER	VALUE
Pad Size on PCB	0.240mm
Pad Shape	Round
Pad Definition	Non-Solder Mask defined pads
Solder Mask Opening	0.290mm Round
Solder Stencil Thickness	0.125mm - 0.150mm
Solder Stencil Aperture Opening (laser cut, 5% tapered walls)	0.300mm Round
Solder Flux Ratio	50/50 by volume
Solder Paste Type	No Clean
Pad Protective Finish	OSP (Entek Cu Plus 106A)
Tolerance — Edge To Corner Ball	$\pm 50\mu\text{m}$
Solder Ball Side Coplanarity	$\pm 20\mu\text{m}$
Maximum Dwell Time Above Liquidous	60 seconds
Maximum Soldering Temperature for Lead-free Devices using a Lead-free Solder Paste	260°C

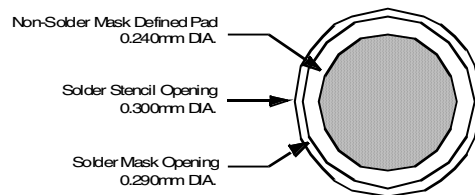

Figure 8. Recommended Non-Solder Mask Defined Pad Illustration

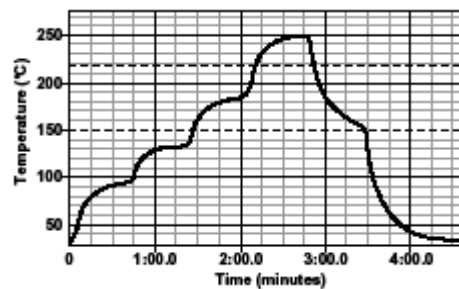

Figure 9. Lead-free (SnAgCu) Solder Ball Reflow Profile

CM1405

Mechanical Details

CM1405-01 Mechanical Specifications

The package dimensions for the CM1405-01 are presented below.

PACKAGE DIMENSIONS						
Package	Custom CSP					
Bumps	20					
Dim	Millimeters			Inches		
	Min	Nom	Max	Min	Nom	Max
A1	3.955	4.000	4.045	0.1557	0.1575	0.1593
A2	1.413	1.458	1.503	0.0556	0.0574	0.0592
B1	0.495	0.500	0.505	0.0195	0.0197	0.0199
B2	0.245	0.250	0.255	0.0096	0.0098	0.0100
B3	0.430	0.435	0.440	0.0169	0.0171	0.0173
B4	0.430	0.435	0.440	0.0169	0.0171	0.0173
C1	0.200	0.250	0.300	0.0079	0.0098	0.0118
C2	0.244	0.294	0.344	0.0096	0.0116	0.0135
D1	0.562	0.606	0.650	0.0221	0.0239	0.0256
D2	0.356	0.381	0.406	0.0140	0.0150	0.0160
# per tape and reel	3500 pieces					
Controlling dimension: millimeters						

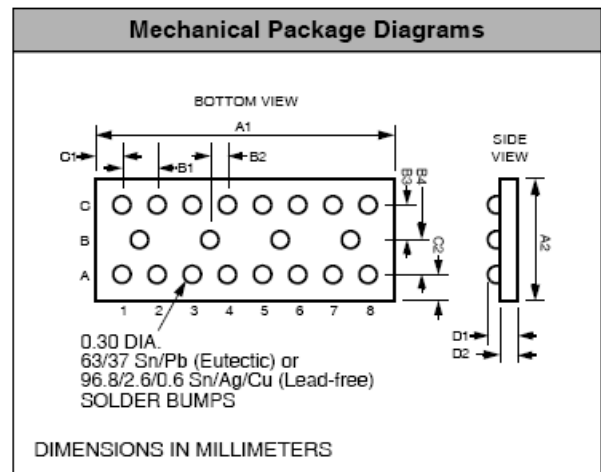

**Package Dimensions for
CM1405-01 Chip Scale Package**

Mechanical Details (cont'd)

CM1405-03 Mechanical Specifications

The package dimensions for the CM1405-03 are presented below.

PACKAGE DIMENSIONS						
Package	Custom CSP					
Bumps	20					
Dim	Millimeters			Inches		
	Min	Nom	Max	Min	Nom	Max
A1	3.955	4.000	4.045	0.1557	0.1575	0.1593
A2	1.413	1.458	1.503	0.0556	0.0574	0.0592
B1	0.495	0.500	0.505	0.0195	0.0197	0.0199
B2	0.245	0.250	0.255	0.0096	0.0098	0.0100
B3	0.430	0.435	0.440	0.0169	0.0171	0.0173
B4	0.430	0.435	0.440	0.0169	0.0171	0.0173
C1	0.200	0.250	0.300	0.0079	0.0098	0.0118
C2	0.244	0.294	0.344	0.0096	0.0116	0.0135
D1	0.575	0.644	0.714	0.0226	0.0254	0.0281
D2	0.368	0.419	0.470	0.0145	0.0165	0.0185
# per tape and reel	3500 pieces					
Controlling dimension: millimeters						

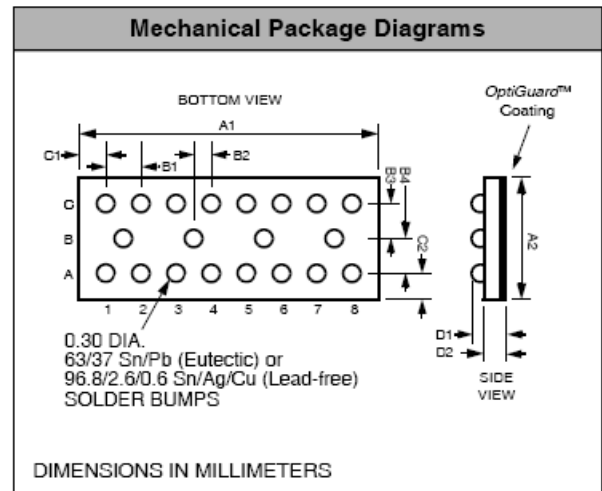

**Package Dimensions for
CM1405-03 Chip Scale Package**

CM1405

CSP Tape and Reel Specifications

PART NUMBER	CHIP SIZE (mm)	POCKET SIZE (mm) $B_0 \times A_0 \times K_0$	TAPE WIDTH W	REEL DIAMETER	QTY PER REEL	P_0	P_1
CM1405-01	4.00 X 1.46 X 0.606	4.11 X 1.57 X 0.76	12mm	330mm (13")	3500	4mm	4mm
CM1405-03	4.00 X 1.46 X 0.644	4.11 X 1.57 X 0.76	12mm	330mm (13")	3500	4mm	4mm

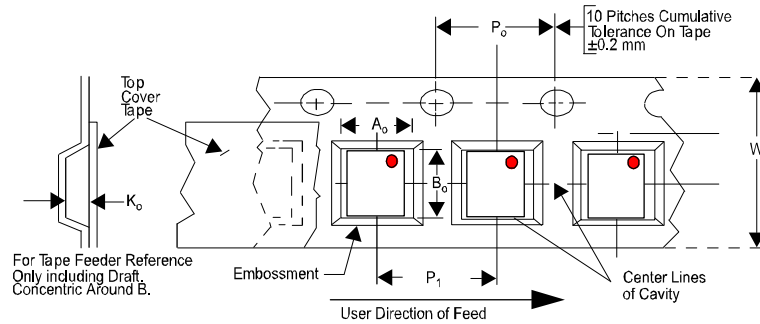



Figure 13. Tape and Reel Mechanical Data

ON Semiconductor and  are registered trademarks of Semiconductor Components Industries, LLC (SCILLC). SCILLC reserves the right to make changes without further notice to any products herein. SCILLC makes no warranty, representation or guarantee regarding the suitability of its products for any particular purpose, nor does SCILLC assume any liability arising out of the application or use of any product or circuit, and specifically disclaims any and all liability, including without limitation special, consequential or incidental damages. "Typical" parameters which may be provided in SCILLC data sheets and/or specifications can and do vary in different applications and actual performance may vary over time. All operating parameters, including "Typicals" must be validated for each customer application by customer's technical experts. SCILLC does not convey any license under its patent rights nor the rights of others. SCILLC products are not designed, intended, or authorized for use as components in systems intended for surgical implant into the body, or other applications intended to support or sustain life, or for any other application in which the failure of the SCILLC product could create a situation where personal injury or death may occur. Should Buyer purchase or use SCILLC products for any such unintended or unauthorized application, Buyer shall indemnify and hold SCILLC and its officers, employees, subsidiaries, affiliates, and distributors harmless against all claims, costs, damages, and expenses, and reasonable attorney fees arising out of, directly or indirectly, any claim of personal injury or death associated with such unintended or unauthorized use, even if such claim alleges that SCILLC was negligent regarding the design or manufacture of the part. SCILLC is an Equal Opportunity/Affirmative Action Employer. This literature is subject to all applicable copyright laws and is not for resale in any manner.

PUBLICATION ORDERING INFORMATION

LITERATURE FULFILLMENT:

Literature Distribution Center for ON Semiconductor
P.O. Box 5163, Denver, Colorado 80217 USA
Phone: 303-675-2175 or 800-344-3860 Toll Free USA/Canada
Fax: 303-675-2176 or 800-344-3867 Toll Free USA/Canada
Email: orderlit@onsemi.com

N. American Technical Support: 800-282-9855
Toll Free USA/Canada
Europe, Middle East and Africa Technical Support:
Phone: 421 33 790 2910
Japan Customer Focus Center
Phone: 81-3-5773-3850

ON Semiconductor Website: www.onsemi.com

Order Literature: <http://www.onsemi.com/orderlit>

For additional information, please contact your local Sales Representative