

RM & RMR CONSTRUCTION

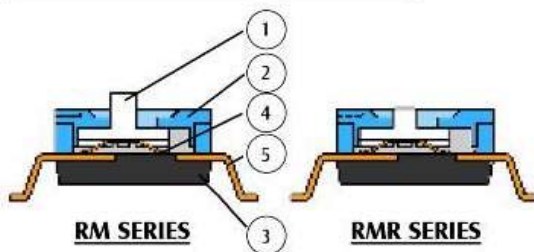

1. RM series (raised actuator) and RMR series (recessed actuator) available for different purposes.
2. Low contact resistance, and self-clean on contact area.
3. Gold plated electrical contact and terminal plating by tin/lead give excellent results when soldering.
4. Double contacts offer high reliability.
5. All materials are UL94V-0 grade fire retardant plastics.

ITEM	Description	Materials	Treatment
1	Actuator	UL94V-0 Nylon 6T thermoplastic	Molded white
2	Cover	UL94V-0 Nylon 6T thermoplastic	Molded black
3	Base	UL94V-0 Nylon 6T thermoplastic	Molded black
4	Contact	Beryllium Copper	Gold plated at contact area
5	Terminal	Brass	Gold plated at contact area and tin/lead plating at terminal

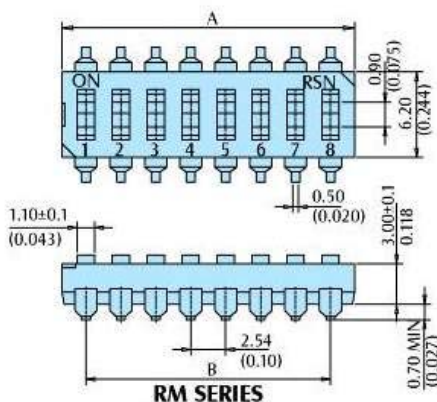

RM SERIES

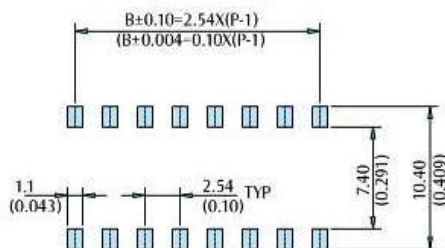

P.C.B. LAYOUT

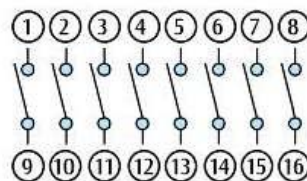

CIRCUIT DIAGRAM

TERMINAL TYPE

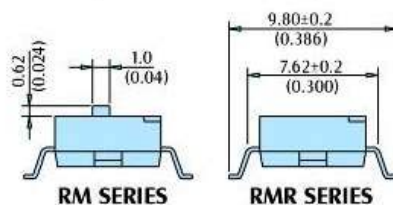

RM SERIES

RMR SERIES

Tape & reel packing (Per EIA standards)
For packing details, please refer to page 13

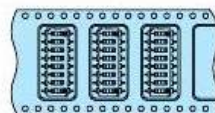

MODEL

PART NO.	NO. OF POS	DIM A	
RMR/RM-01	01	3.48	0.137
RMR/RM-02	02	6.02	0.237
RMR/RM-03	03	8.56	0.337
RMR/RM-04	04	11.1	0.437
RMR/RM-05	05	13.64	0.537
RMR/RM-06	06	16.18	0.637
RMR/RM-07	07	18.72	0.737
RMR/RM-08	08	21.26	0.837
RMR/RM-09	09	23.8	0.937
RMR/RM-10	10	26.34	1.037
RMR/RM-12	12	31.42	1.237

HOW TO ORDER

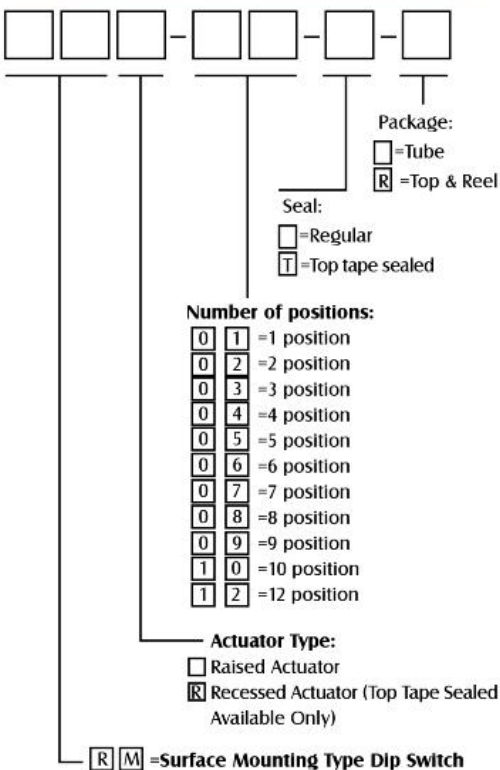

Example: RMR-08-T is a surface mounting Type Dip Switch, Recessed Actuator 8 position, with, top tape sealed.

PACKING

All DIP switches are shipped in standard IC tubes or Tape & Reel Package with all poles in the "OFF" position.

SPECIFICATION

ELECTRICAL

Electrical life: 2000 operation cycles per switch 24VDC, 25mA.
 Non-Switching Rating: 100mA, 50 VDC
 Switching Rating: 25mA, 24VDC.
 Contact resistance: (a) 50mΩ max. at initial
 (b) 100mΩ max. after life test.
 Insulation resistance: 100MΩ min. (at 500VDC)
 Dielectric Strength: 500VAC/1 minute.
 Capacitance: 5pF max.
 Circuit: Single pole single throw

MECHANICAL

Mechanical life: 2000 operations per cycle switch
 Operation Force: 600gf max.
 Stroke: 0.9mm
 Operation Temp: -20° C to +70° C
 Storage Temp: -40° C to +85° C
 Vibration Test: MIL-STD-202F METHOD 201A
 Frequency: 10-55-10HZ/1 min
 Directions: X, Y, Z, three mutually perpendicular directions.
 Time: 2 hours each direction.
 High reliability.
 Shock Test: MIL-STD-202F METHOD 213B.
 CONDITION A
 GRAVITY: 50G (peak value), 11 m/sec.
 Direction and times: 6 sides and three times in each direction. High reliability.

SOLDERING AND CLEANING PROCESSES

For best results, please follow these recommendations:
 Keep all switch contacts in their "OFF" position for all operations.

WAVE SOLDERING: Recommended solder temperature at 235°C±5°C max. 5±1 seconds.

CLEANING PROCESS: Flux clean using force rinse, high agitation or triple bath cleaning method. Freon TF or TE give excellent results. When vapor methods are used, do not subject the switch to solvents at temperatures above 125 F (51 C).

Reflow Temperature Profile. (reference)

