

KEMET, SSR10VS/HS, Commercial Grade, 0.018 H

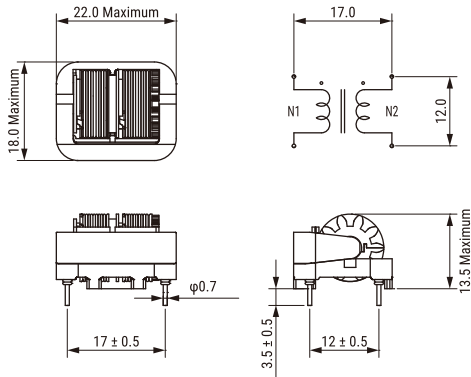

General Information	
Series:	SSR10VS/HS
Style:	Through-Hole Choke
Description:	Common Mode Choke. AC Line Filter. Wide Range Impedance Type.
Features:	Compact Size, Low Profile, Light Weight, High Frequency, Broad Bandwidth
RoHS:	Yes
Lead:	Wire Leads
Miscellaneous:	50 (K) Temperature Rise Max.

Dimensions	
L	22mm MAX
T	18mm MAX
H	13.5mm MAX
S	17mm +/-0.5mm
S1	12mm +/-0.5mm
LL	3.5mm +/-0.5mm
F	0.7mm NOM
Wire Size	0.3mm

Specifications	
Inductance:	18 mH (10 kHz)
Temperature Range:	-25/+120C
Rated Temperature:	120C
Current:	0.8 A
Voltage AC:	250 VAC
Withstanding Voltage:	2400 VAC MAX
Insulation Resistance:	100 MOhms

Packaging Specifications	
Weight:	9 g
Packaging:	Tray
Packaging Quantity:	300

Statements of suitability for certain applications are based on our knowledge of typical operating conditions for such applications, but are not intended to constitute - and we specifically disclaim - any warranty concerning suitability for a specific customer application or use. This Information is intended for use only by customers who have the requisite experience and capability to determine the correct products for their application. Any technical advice inferred from this Information or otherwise provided by us with reference to the use of our products is given gratis, and we assume no obligation or liability for the advice given or results obtained.