

Micropower 1.0A Low Dropout CMOS Regulators

Features

- Regulated output options: 1.5, 1.8, 2.5 and 3.3 volts
- 1.0A output current
- Operates from 3.3V supply (5.0V for CM3002-33)
- Very low dropout voltage on CM3002-33 products (500mV @ 1A)
- Enable Output Control for power-up sequencing
- Low quiescent operating current (< 600µA typical)
- Current limit protection
- Thermal overload protection
- Reverse voltage protection
- Available in thermally-enhanced SOIC-8 and MSOP-8 (CM3002-33MA/MF) packages
- Lead-free versions available

Applications

- Low Voltage "Core" Processors
- Peripheral Adapter Cards
- Portable/Battery-Powered Devices

Table 1: CM3002 Regulator Family

PRODUCT	INPUT VOLTAGE	OUTPUT VOLTAGE
CM3002-15SA/SF	3.3V	1.5V
CM3002-18SA/SF	3.3V	1.8V
CM3002-25SA/SF	3.3V	2.5V
CM3002-33SA/SF	5.0V or 3.3V	3.3V
CM3002-33MA/MF	5.0V or 3.3V	3.3V

Product Description

The CM3002 family of regulators are very low dropout regulators that deliver up to 1.0A of load current at a fixed voltage output. Input and output voltage options for the CM3002 family devices are presented in [Table 1](#).

Operating from a single input supply, these devices are ideally suited for powering low voltage "core" processors, especially where a 3.3V source is already available.

These regulators feature a dedicated control input (EN, Active High) for power-up sequencing flexibility. When this input is taken low, the regulator output is disabled. In this state, the supply current will drop to a low level to ensure all the internal control circuitry still remains active. This provides excellent start-up response whenever the device comes out of shutdown.

The CM3002 family of regulators is fully protected, offering both overload current limiting and high temperature thermal shutdown. Housed in space saving thermally-enhanced SOIC-8 and MSOP-8 (CM3002-33MA/MF) packages, these devices ensure maximum junction-to-ambient power dissipation.

The CM3002 is available with optional lead-free finishing.

Typical Application Circuit

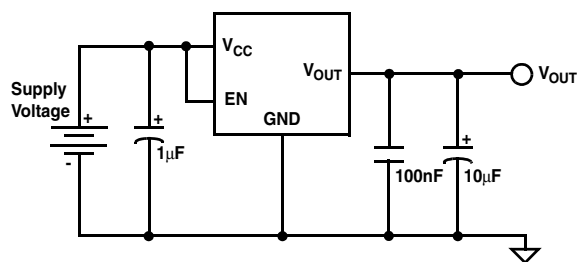

Simplified Electrical Schematic

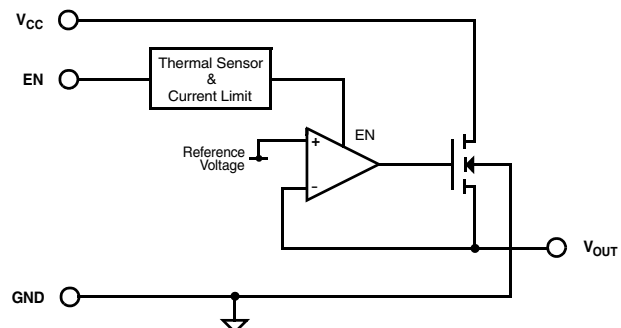

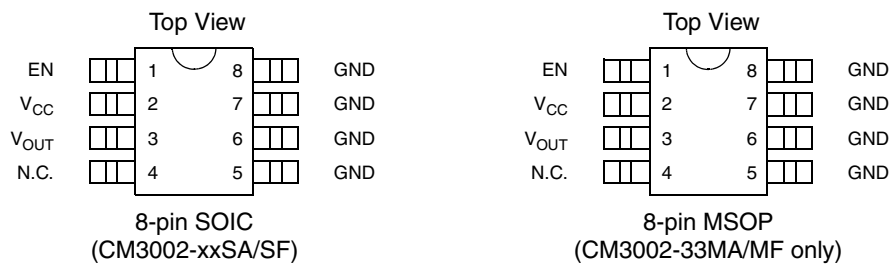
PACKAGE / PINOUT DIAGRAMS

Note: These drawings are not to scale.

PIN DESCRIPTIONS

PIN(S)	NAME	DESCRIPTION
1	EN	<p>A logic input control to enable the regulator output. When EN is asserted (logic high), it allows output regulation to commence. When EN is deasserted (logic low), the regulator pass transistor (N-channel MOSFET) is forced into a high impedance mode.</p> <p>All other internal circuitry is unaffected by the state of the EN input and will always remain powered whenever V_{CC} is present.</p> <p>An internal pull-up current ($2\mu A$) from V_{CC} must be overdriven in order to apply a Logic Low to the EN control input.</p> <p>The EN control input is intended to be used for power-up sequencing.</p>
2	V_{CC}	The input power supply for the regulator. If this input is within a few inches of the main supply filter, a capacitor may not be necessary. Otherwise an input filter capacitor of approximately $1\mu F$ to $10\mu F$ will ensure adequate filtering.
3	V_{OUT}	The regulator voltage output used to power the load. A nominal output capacitor of $10\mu F$ is sufficient to minimize any transient disturbances under normal operating conditions. Additional output capacitance can be used to further improve transient load response.
4	N.C.	These pins have no connection to the internal device. To provide additional thermal performance, these pins can be connected directly to the PC board GND plane.
5,6,7,8	GND	The negative reference for all voltages.

Ordering Information
PART NUMBERING INFORMATION

Regulator	Pins	Package	Standard Finish		Lead-free Finish	
			Ordering Part Number ¹	Part Marking	Ordering Part Number ¹	Part Marking
CM3002-15	8	Power SOIC	CM3002-15SA	CM3002-15SA	CM3002-15SF	CM3002-15SF
CM3002-18	8	Power SOIC	CM3002-18SA	CM3002-18SA	CM3002-18SF	CM3002-18SF
CM3002-25	8	Power SOIC	CM3002-25SA	CM3002-25SA	CM3002-25SF	CM3002-25SF
CM3002-33	8	Power SOIC	CM3002-33SA	CM3002-33SA	CM3002-33SF	CM3002-33SF
CM3002-33	8	Power MSOP	CM3002-33MA	233	CM3002-33MF	233R

Note 1: Parts are shipped in Tape & Reel form unless otherwise specified.

Specifications

ABSOLUTE MAXIMUM RATINGS		
PARAMETER	RATING	UNITS
ESD Protection (HBM)	±2000	V
Pin Voltages		
V _{CC}	[GND - 0.4] to [+6.0]	V
EN	[GND - 0.4] to [+6.0]	V
V _{OUT}	[GND - 0.4] to [+6.0]	V
Storage Temperature Range	-40 to +150	°C
Operating Temperature Range		
Ambient	0 to +70	°C
Junction	0 to +150	°C
Power Dissipation (Note 1)	Internally Limited	W

Note 1: The SOIC and MSOP packages are thermally enhanced through the use of a fused integral leadframe. The power rating is based on a printed circuit board heat spreading capability equivalent to 2 square inches of copper connected to the GND pins. Typical multi-layer boards using power plane construction will provide this heat spreading ability without the need for additional dedicated copper area. Please consult with factory for thermal evaluation assistance.

STANDARD OPERATING CONDITIONS		
PARAMETER	RATING	UNITS
V _{CC} (CM3002-15SA, CM3002-18SA, CM3002-25SA)	3.0 to 3.6	V
V _{CC} (CM3002-33SA, CM3002-33MA)	3.0 to 5.5	V
Ambient Operating Temperature Range	0 to +70	°C
Load Current	0 to +1000	mA
C _{EXT}	10 ±20%	µF

Specifications (cont'd)

ELECTRICAL OPERATING CHARACTERISTICS (SEE NOTE 1)						
SYMBOL	PARAMETER	CONDITIONS	MIN	TYP	MAX	UNITS
V_{OUT}	Regulator Output Voltage					
	CM3002-15SA/SF	$0mA < I_{LOAD} < 1000mA$	1.42	1.50	1.58	V
	CM3002-18SA/SF	$0mA < I_{LOAD} < 1000mA$	1.72	1.80	1.88	V
	CM3002-25SA/SF	$0mA < I_{LOAD} < 1000mA$	2.40	2.50	2.60	V
	CM3002-33SA/SF, -33MA/MF	$0mA < I_{LOAD} < 1000mA; V_{CC}=5.0$	3.10	3.30	3.50	V
I_{LIM}	Overload Current Limit			1500		mA
V_{RLOAD}	Load Regulation					
	CM3002-15SA/SF, -18SA/SF, -25SA/SF	$10mA < I_{LOAD} < 1000mA; V_{CC}=3.3V$		20		mV
	CM3002-33SA/SF, -33MA/MF	$10mA < I_{LOAD} < 1000mA; V_{CC}=5.0V$		20		mV
V_{RLINE}	Line Regulation _{xx}					
	CM3002-15SA/SF	$I_{LOAD} = 5mA; 3.0V \leq V_{CC} \leq 5.5V$		20		mV
	CM3002-18SA/SF	$I_{LOAD} = 5mA; 3.0V \leq V_{CC} \leq 5.5V$		20		mV
	CM3002-25SA/SF	$I_{LOAD} = 5mA; 3.0V \leq V_{CC} \leq 5.5V$		30		mV
	CM3002-33SA/SF, -33MA/MF	$I_{LOAD} = 5mA; 4.5V \leq V_{CC} \leq 5.5V$		20		mV
I_Q	Quiescent Current					
	CM3002-15SA/SF	EN tied to V_{CC} ; $I_{LOAD} = 0mA$		500	900	μA
	CM3002-18SA/SF	EN tied to V_{CC} ; $I_{LOAD} = 0mA$		500	900	μA
	CM3002-25SA/SF	EN tied to V_{CC} ; $I_{LOAD} = 0mA$		500	900	μA
	CM3002-33SA/SF, -33MA/MF	EN tied to V_{CC} ; $I_{LOAD} = 0mA$		600	900	μA
I_Q	Quiescent Current					
	CM3002-15SA/SF	EN tied to GND; $I_{LOAD} = 0mA$		150	300	μA
	CM3002-18SA/SF	EN tied to GND; $I_{LOAD} = 0mA$		150	300	μA
	CM3002-25SA/SF	EN tied to GND; $I_{LOAD} = 0mA$		150	300	μA
	CM3002-33SA/SF, -33MA/MF	EN tied to GND; $I_{LOAD} = 0mA$		200	300	μA
I_{GND}	Ground Current					
	CM3002-15SA/SF	$I_{LOAD} = 0mA$		500	900	μA
	CM3002-18SA/SF	$I_{LOAD} = 0mA$		500	900	μA
	CM3002-25SA/SF	$I_{LOAD} = 0mA$		500	900	μA
	CM3002-33SA/SF, -33MA/MF	$I_{LOAD} = 0mA$		600	900	μA
I_{GND}	Ground Current					
	CM3002-15SA/SF	$I_{LOAD} = 1000mA$		500	900	μA
	CM3002-18SA/SF	$I_{LOAD} = 1000mA$		500	900	μA
	CM3002-25SA/SF	$I_{LOAD} = 1000mA$		500	900	μA
	CM3002-33SA/SF, -33MA/MF	$I_{LOAD} = 1000mA$		600	900	μA
I_{RCC}	V_{CC} Pin Reverse Leakage	$V_{OUT} = 3.3V; V_{CC} = 0V$		1	100	μA
V_{IH}	Enable Input Logic High Threshold		1.5			V
V_{IL}	Enable Input Logic Low Threshold				0.3	V
I_{EN}	Enable Input Current	Internal current source from V_{CC}		2	10	μA
$T_{DISABLE}$	Shutdown Temperature			160		$^{\circ}C$
T_{HYST}	Thermal Hysteresis			25		$^{\circ}C$

Note 1: Operating Characteristics are over Standard Operating Conditions unless otherwise specified.

Performance Information

CM3002-15SA/SF Typical DC Characteristics (nominal conditions unless specified otherwise)

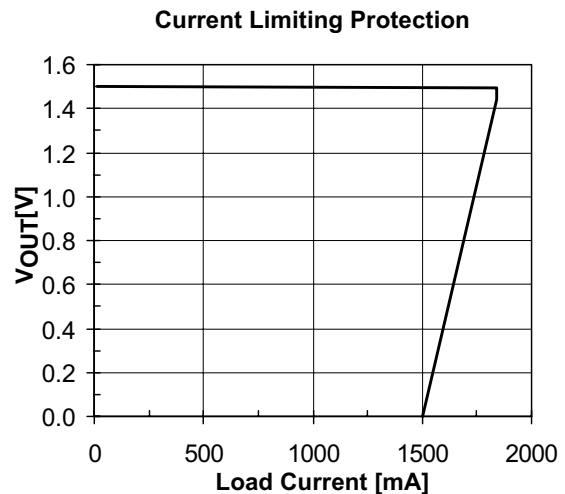
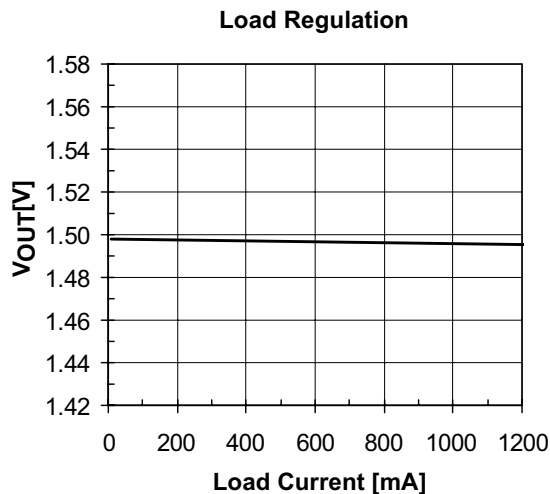
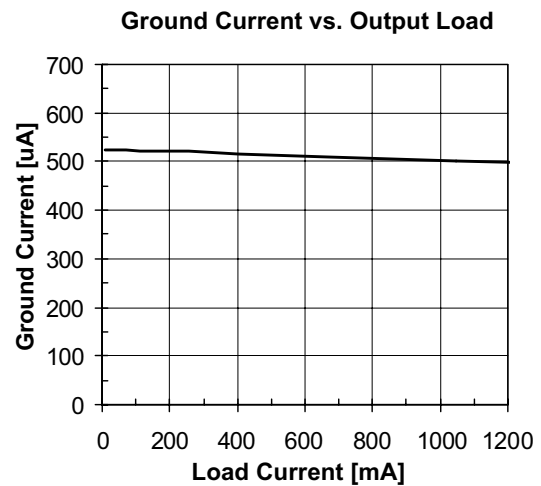
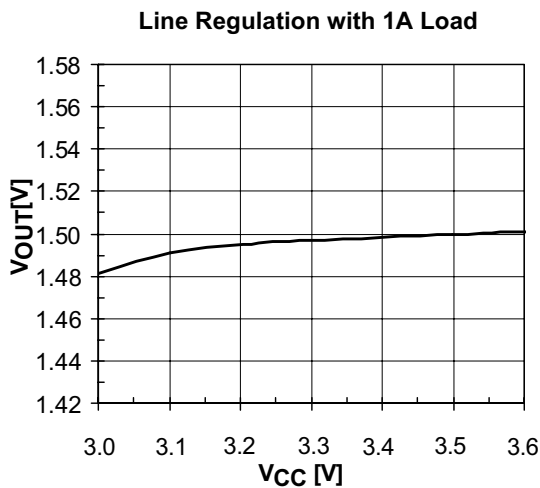
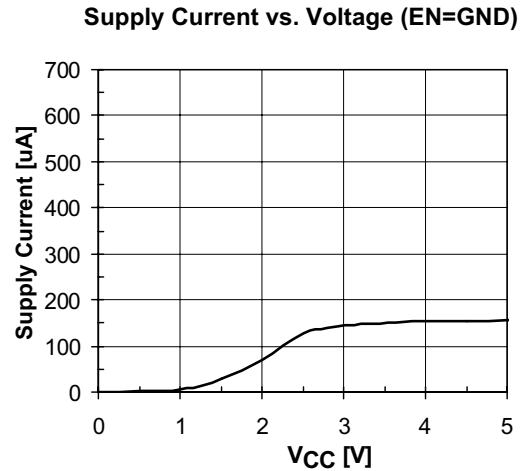
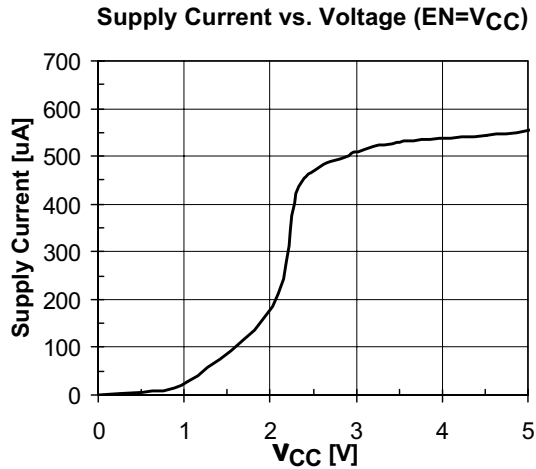

Performance Information (cont'd)

CM3002-18SA/SF Typical DC Characteristics (nominal conditions unless specified otherwise)

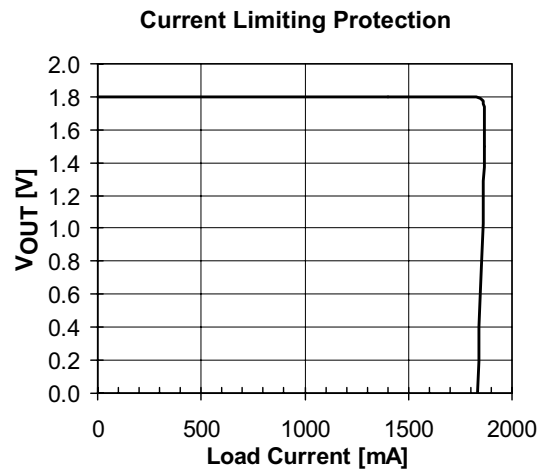
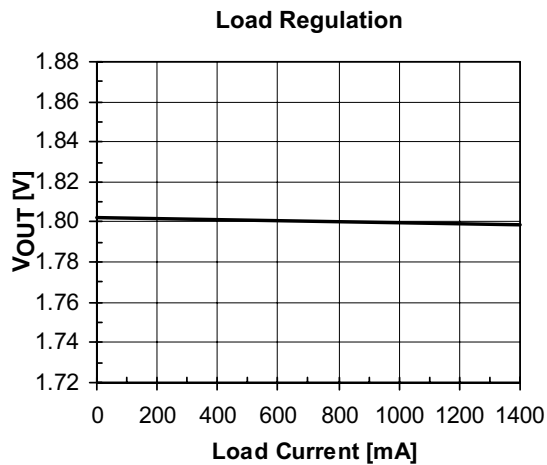
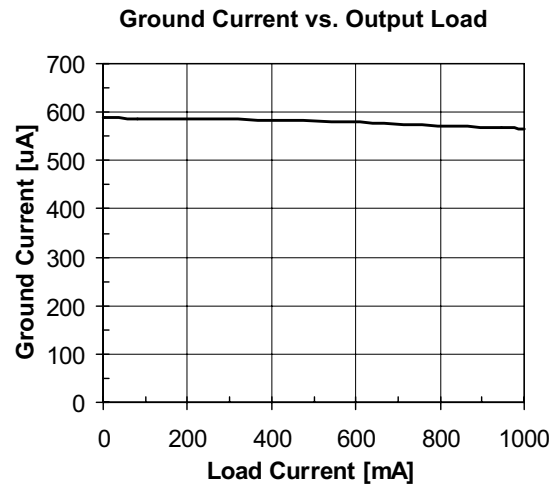
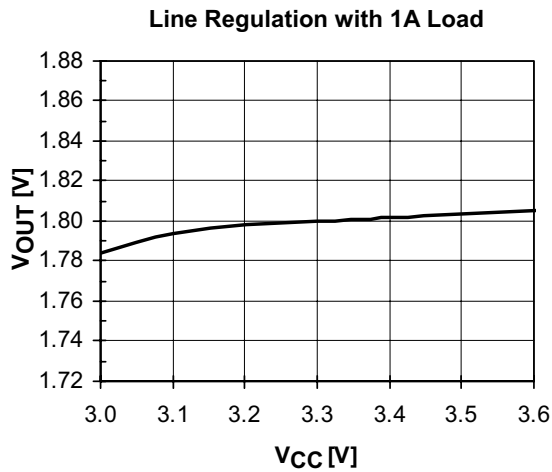
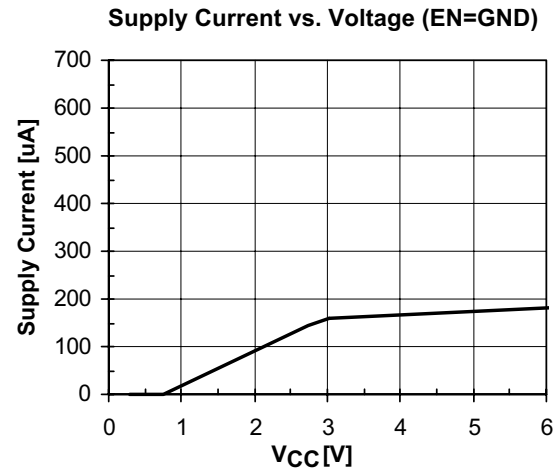
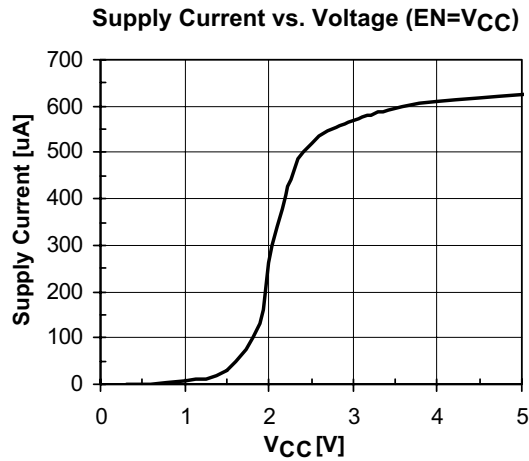

Performance Information (cont'd)

CM3002-25SA/SF Typical DC Characteristics (nominal conditions unless specified otherwise)

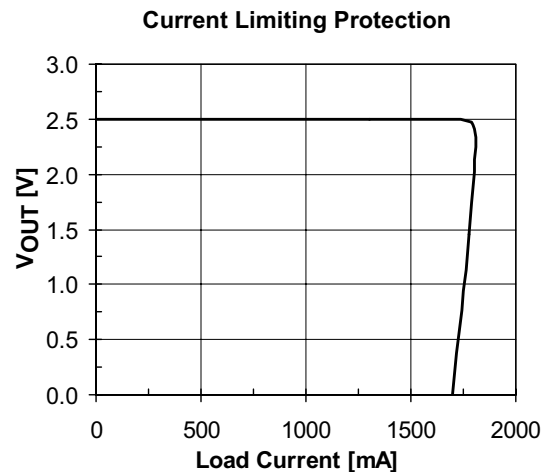
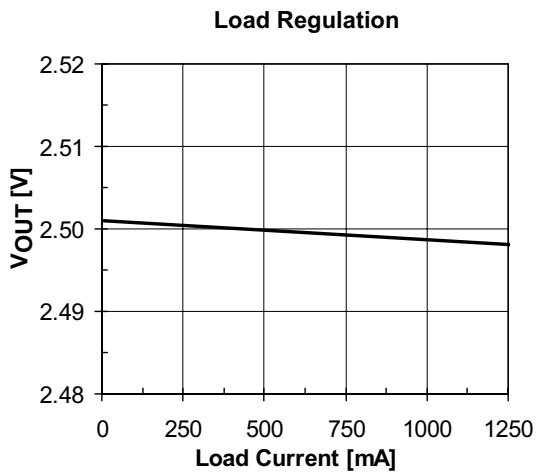
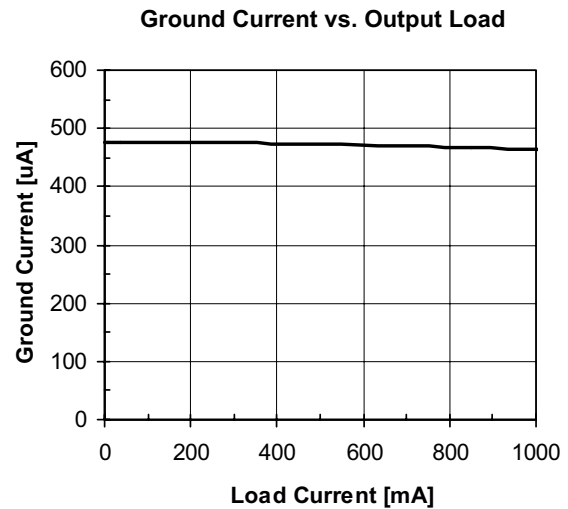
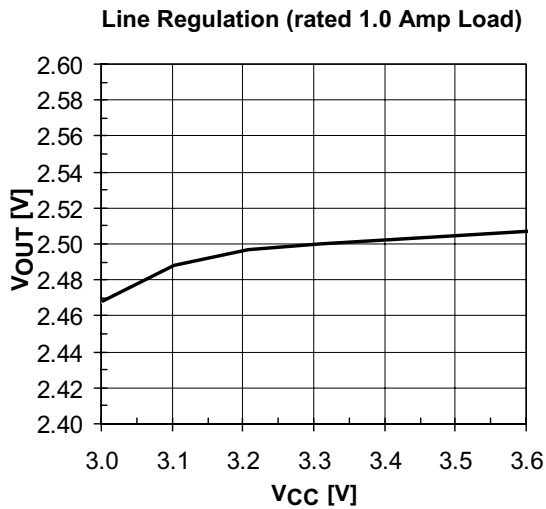
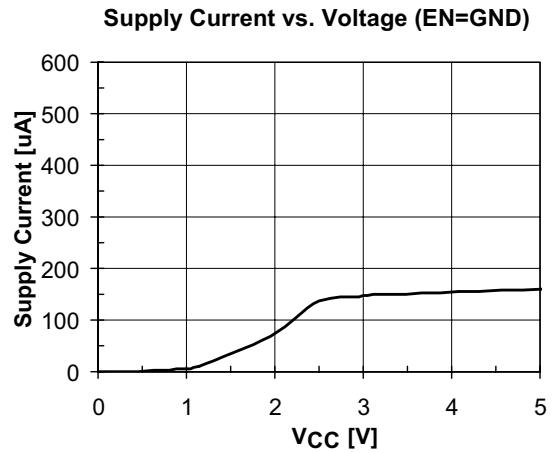
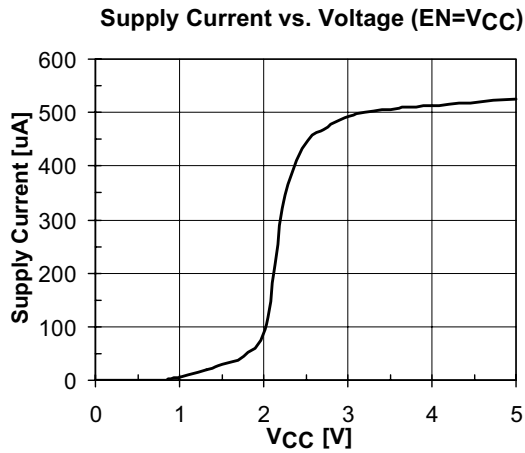

Performance Information (cont'd)

CM3002-33SA/SF & CM3002-33MA/MF Typical DC Characteristics

(nominal conditions unless specified otherwise, data representative of SOIC packaged -33SA/SF devices)

Supply Current vs. Voltage (EN=V_{CC})

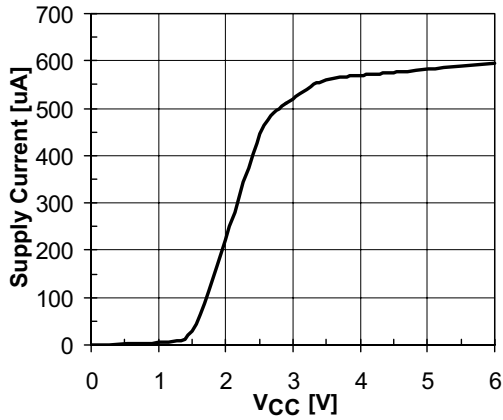

Supply Current vs. Voltage (EN=GND)

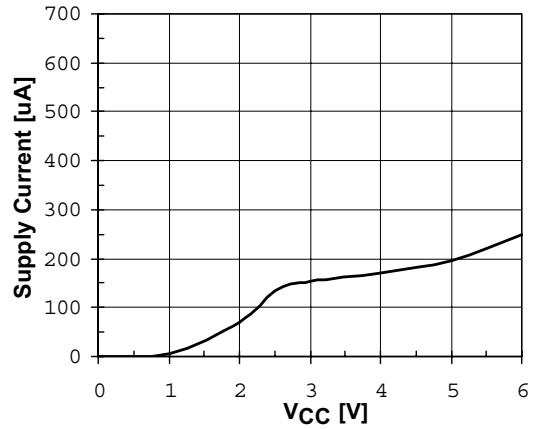

Line Regulation with 5mA & 1A Load

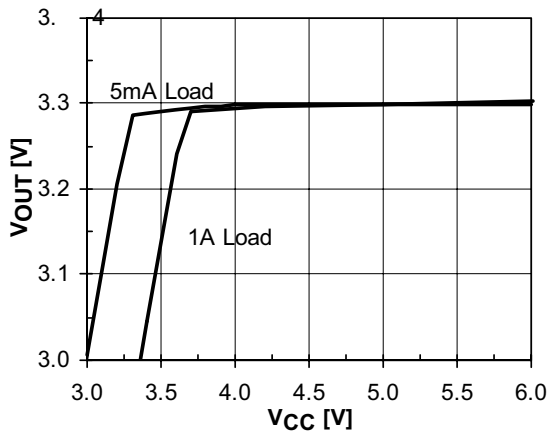

Ground Current vs. Output Load

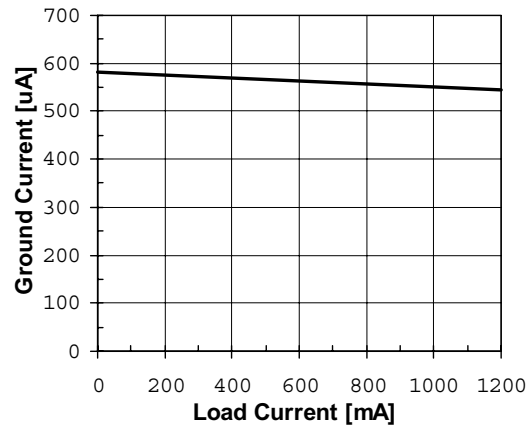

Dropout Voltage vs. Load (V_{out}=3.2V)

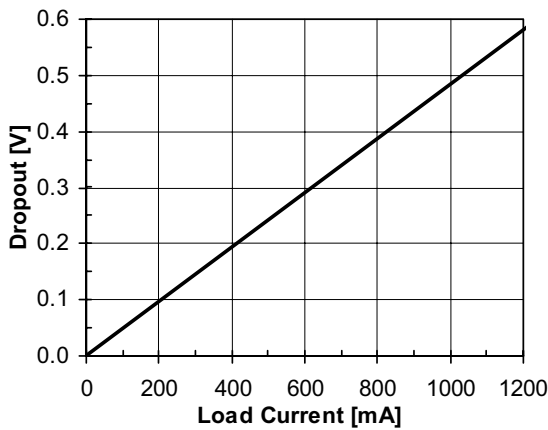

Current Limiting Protection

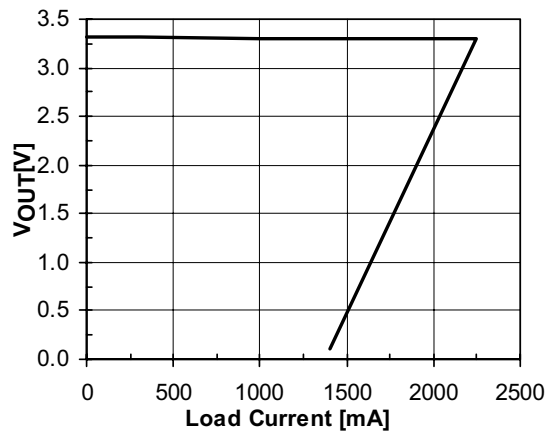

Performance Information (cont'd)

CM3002-33SA & CM3002-33MA/MF Typical DC Characteristics (continued)

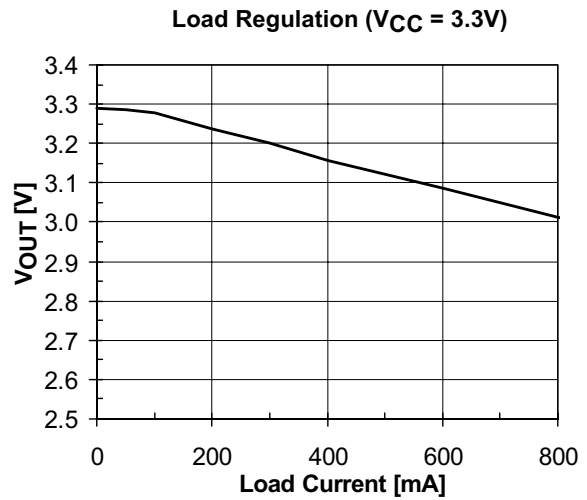
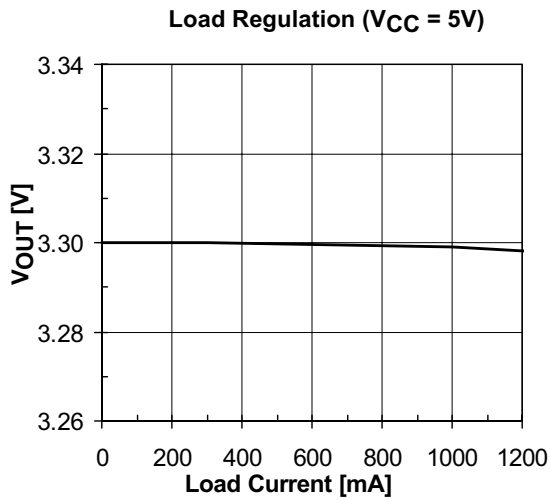

Performance Information (cont'd)

CM3002-15SA/SF Typical Transient Characteristics (nominal conditions unless specified otherwise)

Cold Start Power-up with Rated Load

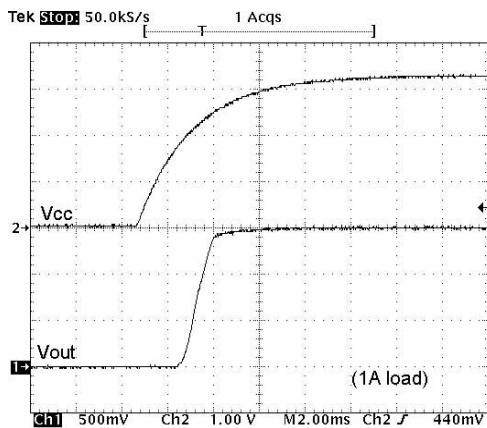

Full Power Down with Rated Load

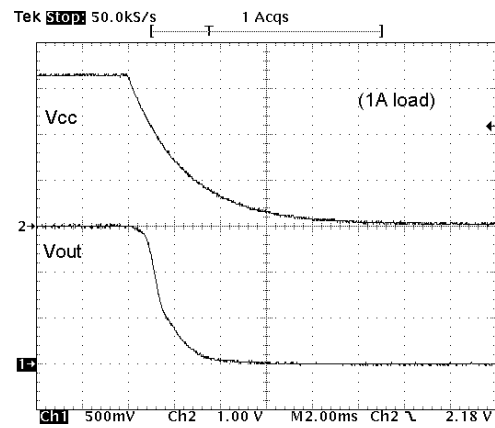

Power-Up Sequencing using Enable Input

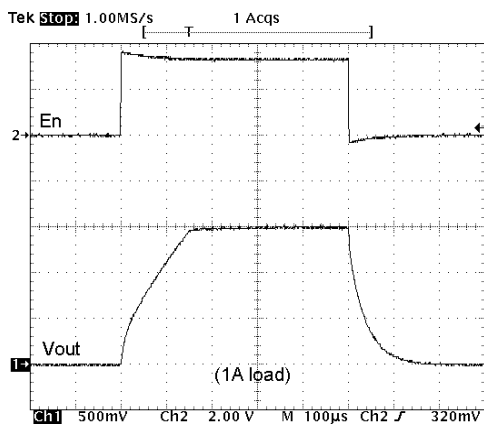

Line Transient Step Response (0.6Vp-p)

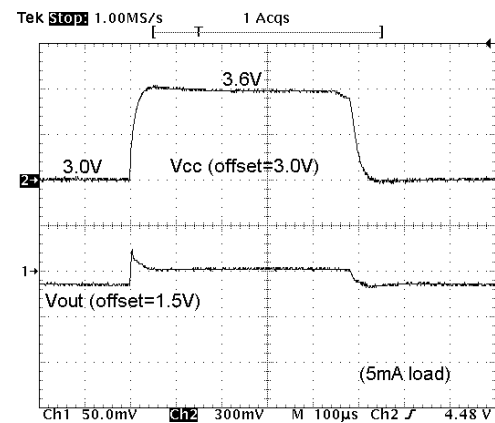

Load Transient Response (50mA to 450mA)

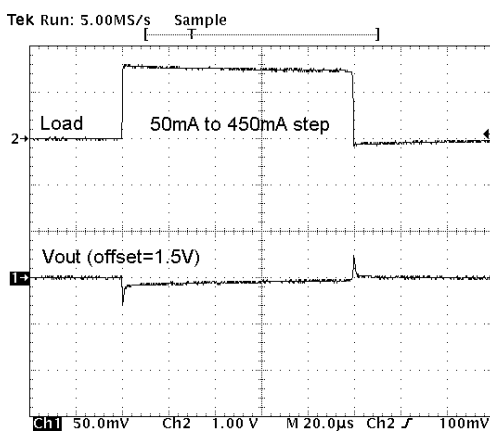

Load Transient Response (100mA to 900mA)

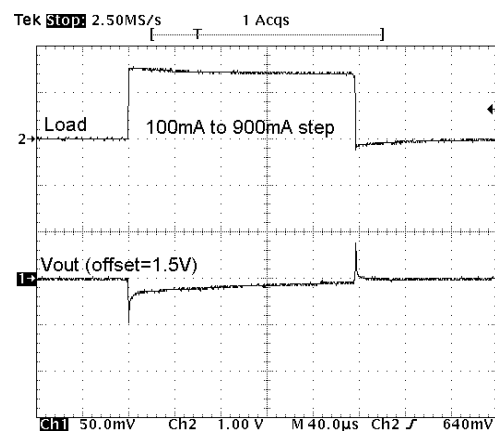

Performance Information (cont'd)

CM3002-18SA/SF Typical Transient Characteristics (nominal conditions unless specified otherwise)

Cold Start Power-up with Rated Load

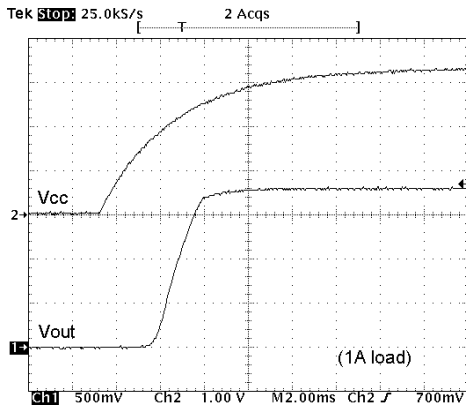

Full Power Down with Rated Load

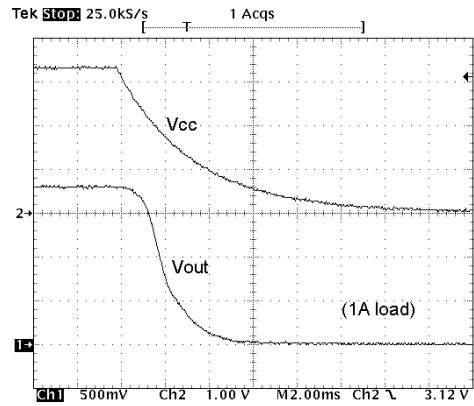

Power-Up Sequencing using Enable Input

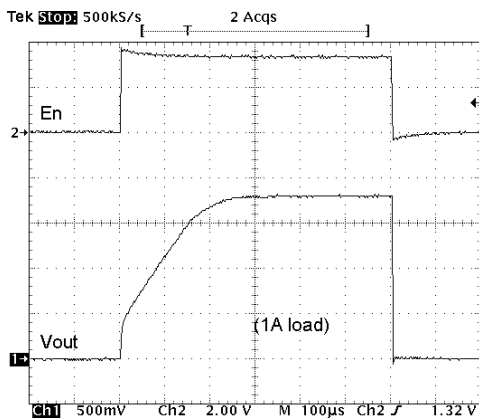

Line Transient Step Response (1Vp-p)

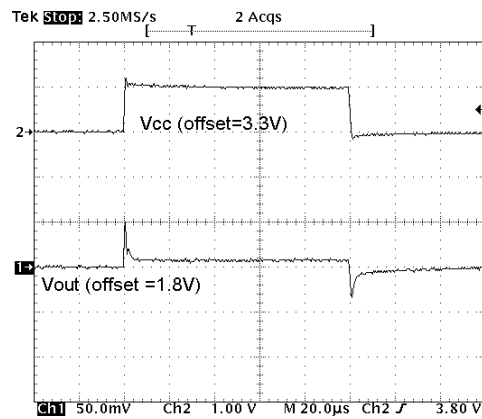

Load Transient Response (50mA to 500mA)

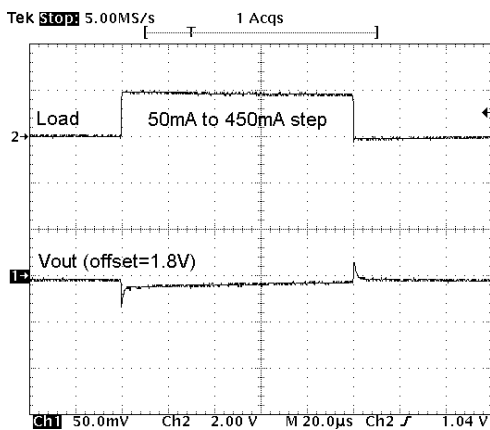

Load Transient Response (100mA to 900mA)

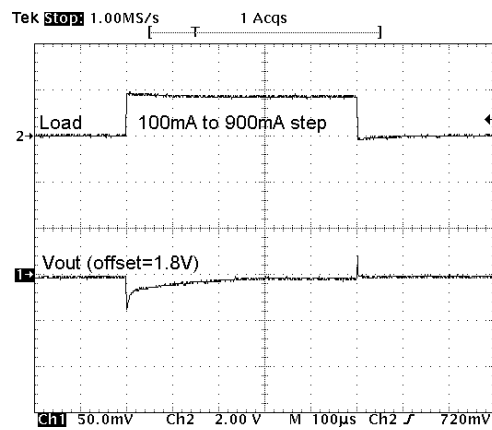

Performance Information (cont'd)

CM3002-25SA/SF Typical Transient Characteristics (nominal conditions unless specified otherwise)

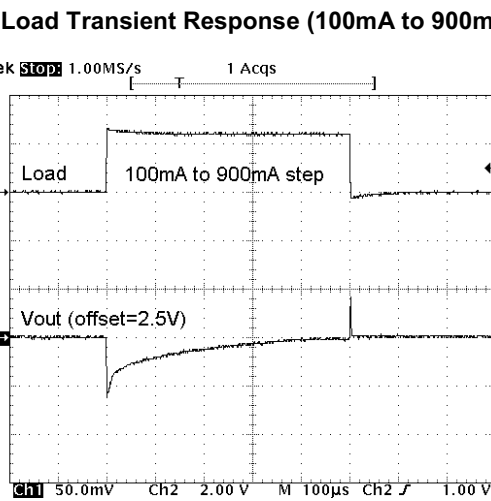
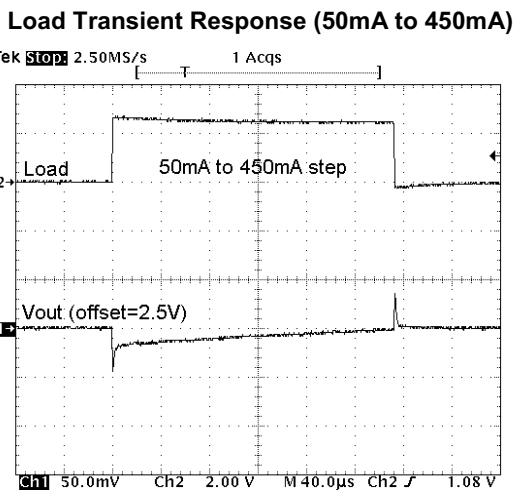
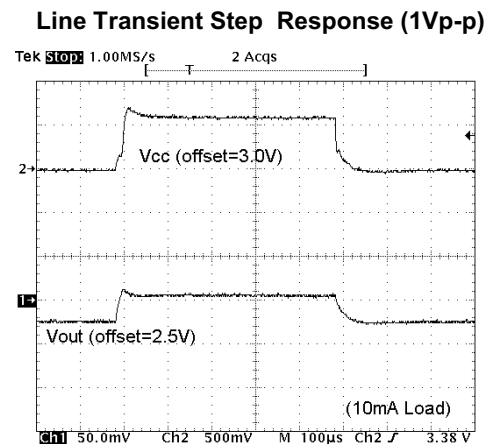
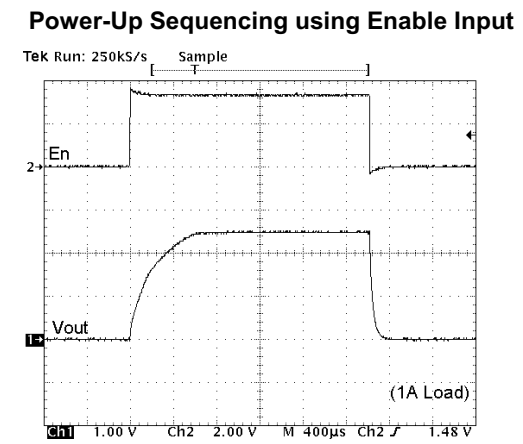
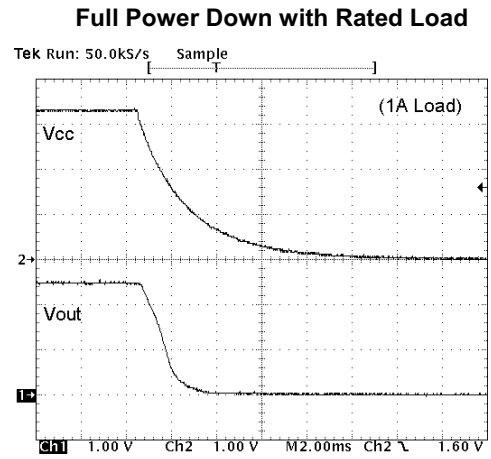
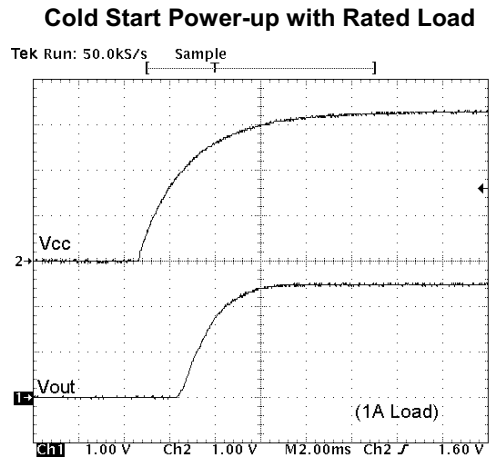

Performance Information (cont'd)

CM3002-33SA/SF & CM3002-33MA/MF Typical Transient Characteristics (nominal conditions unless specified otherwise)

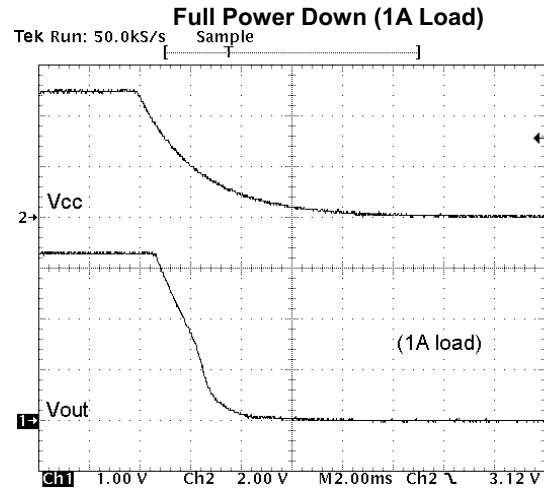
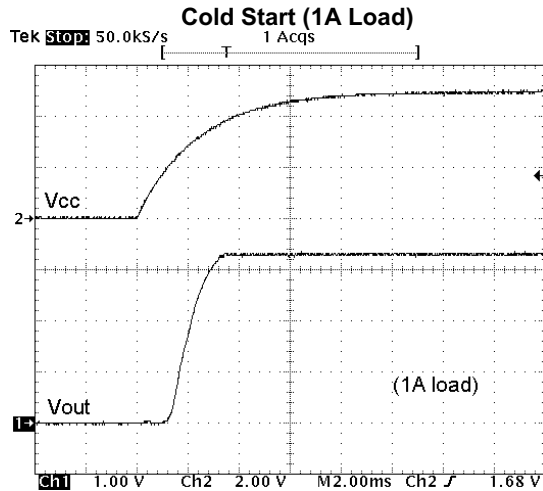

Line Transient Response (4.0V to 5.0V Line Step)

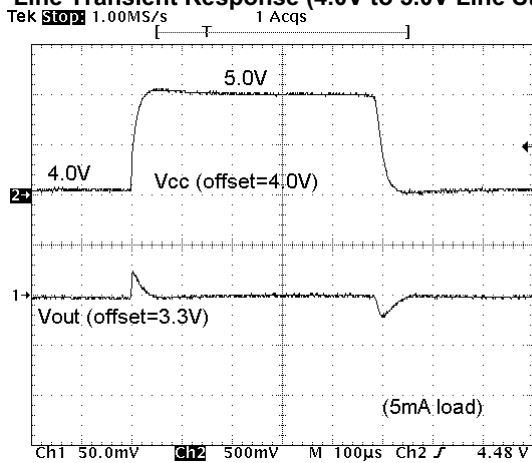

Power-Up Sequencing using Enable Input (1A Load)

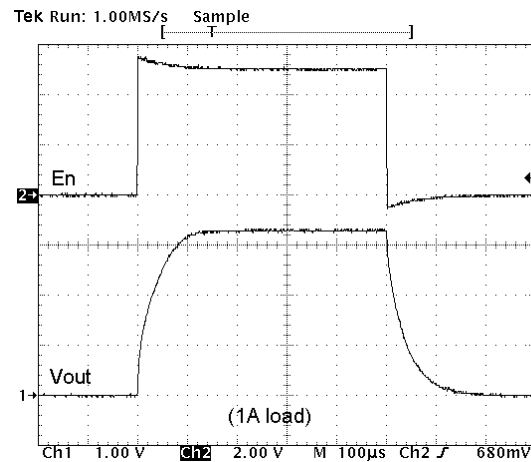

Load Transient Response (Vcc=5V)

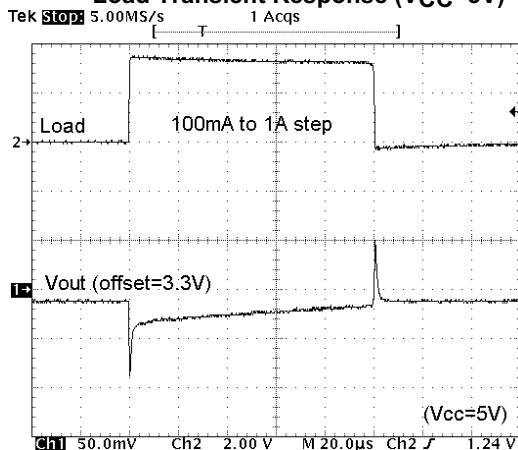

Load Transient Response (Vcc=3.3V)

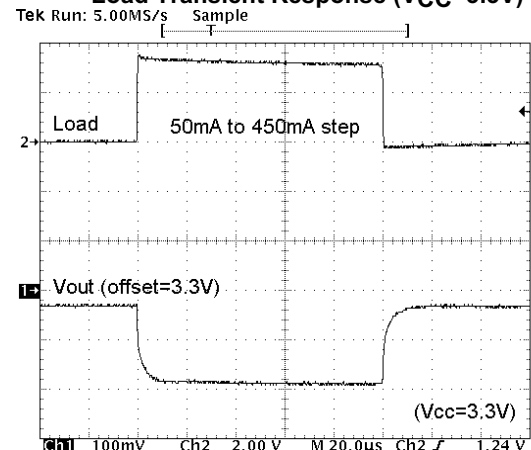

Performance Information (cont'd)

Typical Thermal Characteristics

The overall junction to ambient thermal resistance (θ_{JA}) for device power dissipation (P_D) consists primarily of two paths in series. The first path is the junction to the case (θ_{JC}) which is defined by the package style, and the second path is case to ambient (θ_{CA}) thermal resistance which is dependent on board layout. The final operating junction temperature for any set of conditions can be estimated by the following thermal equation:

$$\begin{aligned} T_{JUNC} &= T_{AMB} + P_D * (\theta_{JC}) + P_D * (\theta_{CA}) \\ &= T_{AMB} + P_D * (\theta_{JA}) \end{aligned}$$

The CM3002 family uses thermally enhanced SOIC and MSOP packages where all the GND pins (5 through 8) are integral to the leadframe. When this package is mounted on a double sided printed circuit board with two square inches of copper allocated for "heat spreading", the resulting θ_{JA} is about 50° C/W for the SOIC package and 70° C/W for the MSOP package.

Based on a maximum power dissipation of 0.8W (Load x Vin-Vout = 1.0A x [3.3V-2.5V]) with an ambient of 70° C, the resulting junction temperature for a SOIC-packaged device will be:

$$\begin{aligned} T_{JUNC} &= T_{AMB} + P_D * (\theta_{JA}) \\ &= 70^\circ \text{C} + 0.8\text{W} * (50^\circ \text{C/W}) \\ &= 70^\circ \text{C} + 40^\circ \text{C} = 110^\circ \text{C} \end{aligned}$$

Thermal characteristics were measured using a double sided board with two square inches of copper area connected to the GND pins for "heat spreading".

Measurements showing performance up to a junction temperature of 125° C are presented in [Figure 1](#), [Figure 2](#), [Figure 3](#) and [Figure 4](#). They were performed under light load conditions (5mA); this allows the ambient temperature to be representative of the internal junction temperature.

Note: The use of multi-layer board construction with separate ground and power planes will further enhance the overall thermal performance. In the event of no copper area being dedicated for heat spreading, a multi-layer board construction using only the minimum size pad layout will typically provide a CM3002 device packaged in a SOIC package with an overall θ_{JA} of 50° C/W, which allows up to 0.8W to be dissipated safely.

Please consult CAMD Technical Support for assistance with thermal analysis of the CM3002 family of regulators with respect to a specific application.

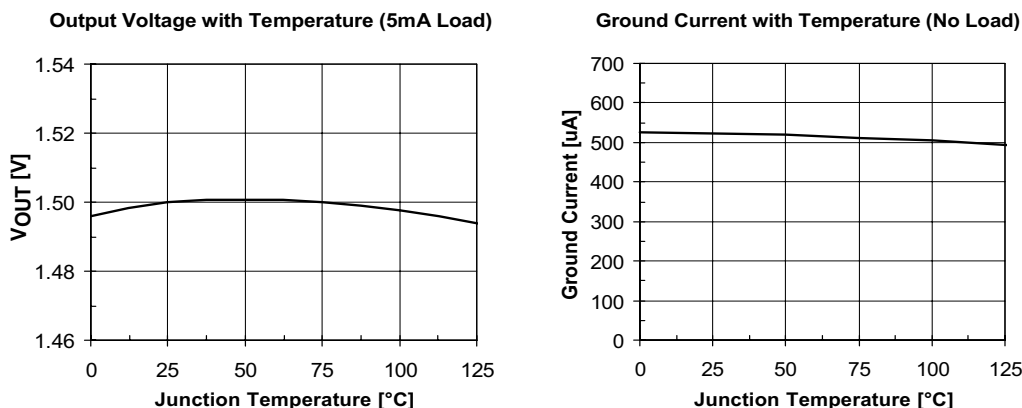

Figure 1. CM3002-15SA/SF Performance vs. Temperature

Performance Information (cont'd)

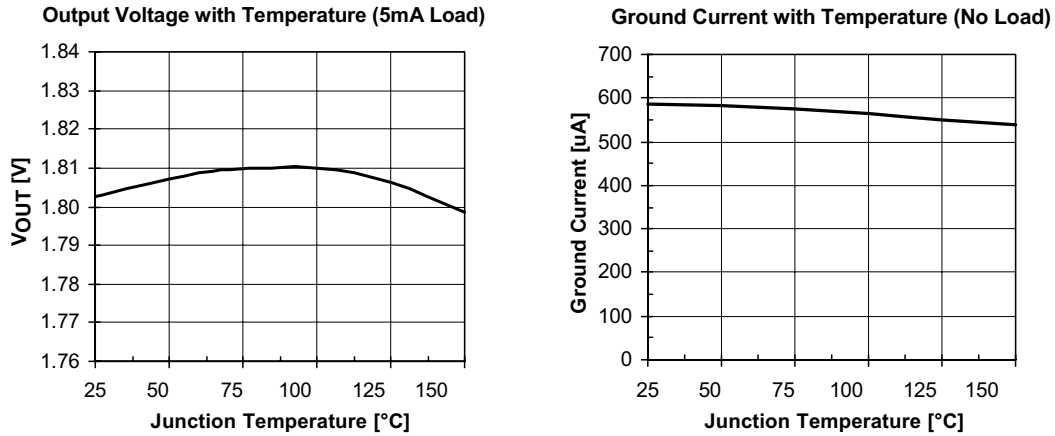

Figure 2. CM3002-18SA/SF Performance vs. Temperature

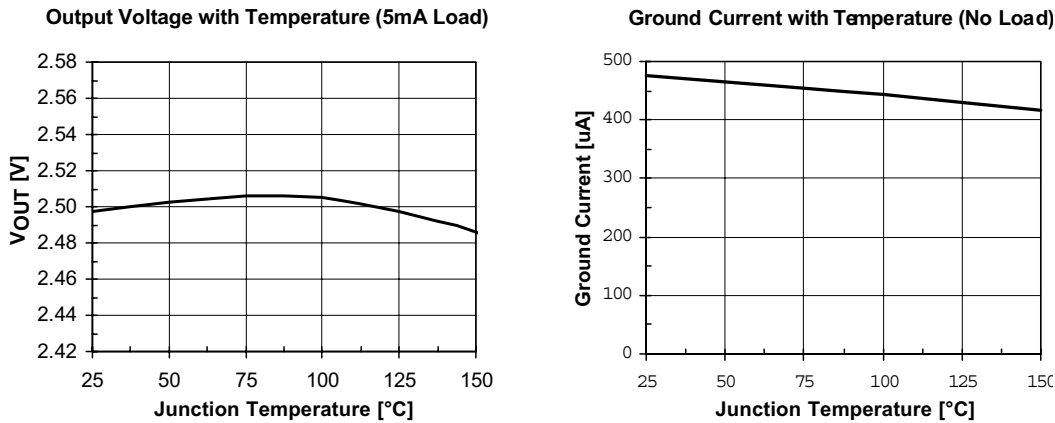

Figure 3. CM3002-25SA/SF Performance vs. Temperature

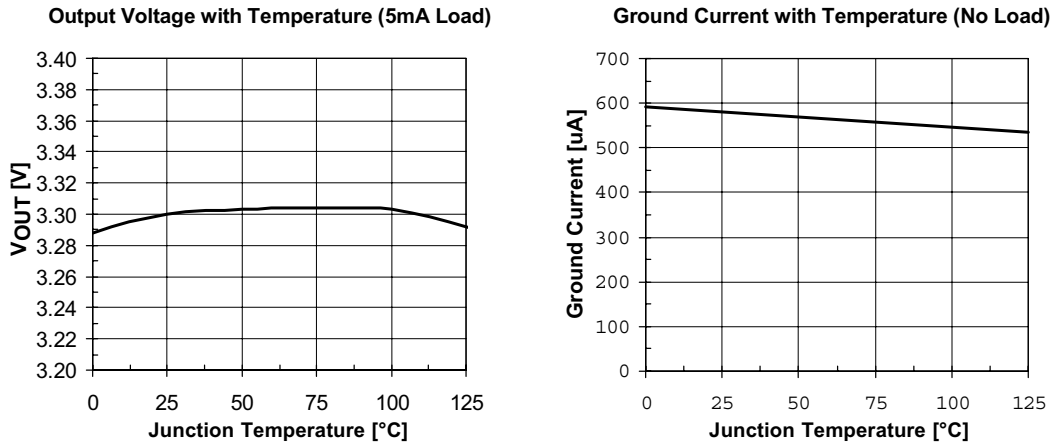

Figure 4. CM3002-33SA/SF & CM3002-33MA/MF Performance vs. Temperature

Mechanical Details

CM3002 devices are packaged in 8-pin Narrow SOIC (CM3002-xxSA/SF) and 8-pin MSOP (CM3002-33MA/MF only) packages.

SOIC-8 Mechanical Specifications:

Dimensions for CM3002-xxSA/SF devices packaged in 8-pin Narrow SOIC packages are presented below.

For complete information on the SOIC-8 package, see the California Micro Devices SOIC Package Information document.

PACKAGE DIMENSIONS				
Package	SOIC			
Pins	8			
Dimensions	Millimeters		Inches	
	Min	Max	Min	Max
A	1.35	1.75	0.053	0.069
A₁	0.10	0.25	0.004	0.010
B	0.33	0.51	0.013	0.020
C	0.19	0.25	0.007	0.010
D	4.80	5.00	0.189	0.197
E	3.80	4.19	0.150	0.165
e	1.27 BSC		0.050 BSC	
H	5.80	6.20	0.228	0.244
L	0.40	1.27	0.016	0.050
# per tube	100 pcs*			
# per tape and reel	2500 pcs			
Controlling dimension: inches				

* This is an approximate number which may vary.

Mechanical Package Diagrams

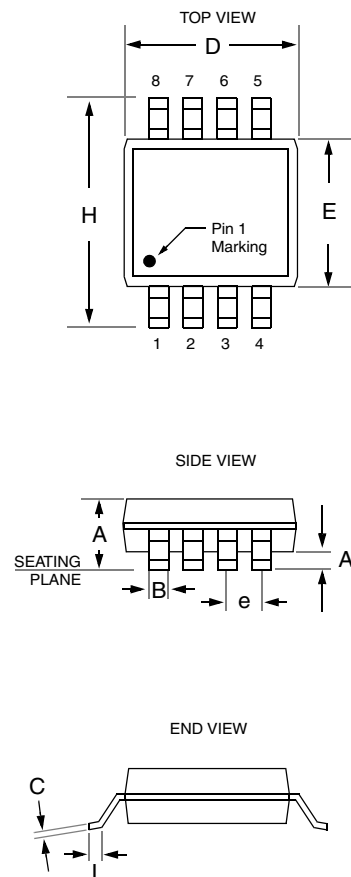

Package Dimensions for SOIC-8

Mechanical Details (cont'd)

MSOP-8 Mechanical Specifications:

CM3002-33MA/MF devices are packaged in 8-pin MSOP packages. Dimensions are presented below.

For complete information on the MSOP-8 package, see the California Micro Devices MSOP Package Information document.

PACKAGE DIMENSIONS				
Package	MSOP			
Pins	8			
Dimensions	Millimeters		Inches	
	Min	Max	Min	Max
A	0.87	1.17	0.034	0.046
A1	0.05	0.25	0.002	0.010
B	0.30 (typ)		0.012 (typ)	
C	0.18		0.007	
D	2.90	3.10	0.114	0.122
E	2.90	3.10	0.114	0.122
e	0.65 BSC		0.025 BSC	
H	4.78	4.98	0.188	0.196
L	0.52	0.54	0.017	0.025
# per tube	80 pcs*			
# per tape and reel	4000 pcs			
Controlling dimension: inches				

* This is an approximate number which may vary.

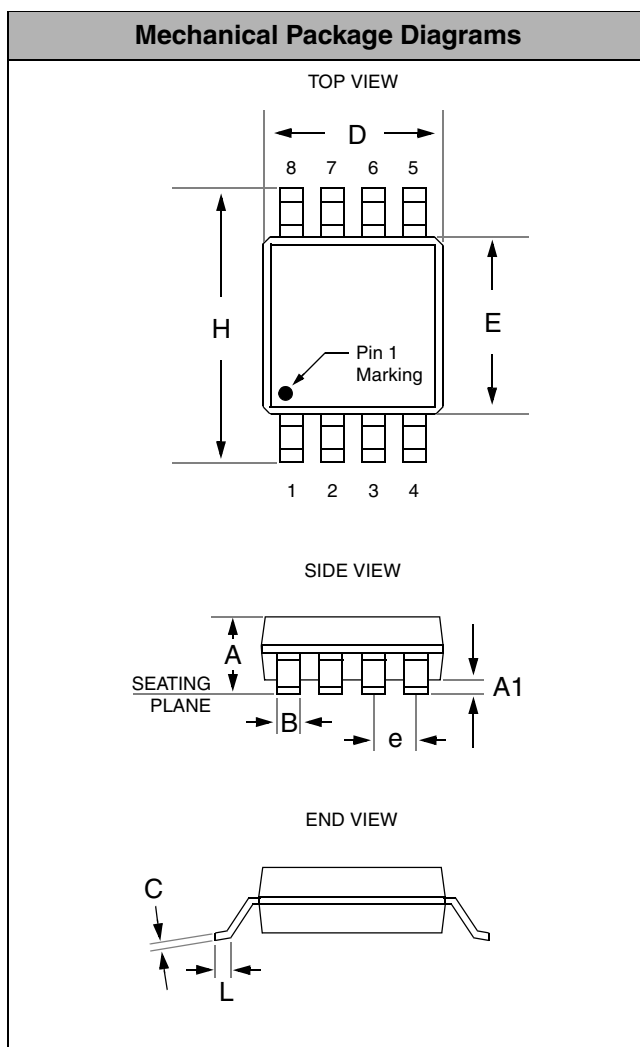

Package Dimensions for MSOP-8