



**Chokes for Data and Signal Lines**

**B82790C0\*/K0\*N2**

**Double Chokes**

**B82790S0\*/L0\*N2**

**SMD**

**Rated voltage 42 VAC/80 DC**  
**Rated current 200 to 1000 mA**  
**Rated inductance 5  $\mu$ H to 4,7 mH**



#### Construction

- Current-compensated ring core choke with ferrite core
- Bifilar winding (B82790C0\*/K0\*)
- Sector winding (B82790S0\*/L0\*)

#### Features

- Case flame-retardant as per UL 94 V-0
- Suitable for reflow soldering

*Special types for conductive adhesion  
and ambient temperatures up to 150°C on request*

#### Applications

- B82790C0\*/K0\*:  
Suppression of asymmetrical interference coupled in on lines, whereas data signals up to some MHz can pass unaffectedly
- B82790S0\*/L0\*:  
Suppression of asymmetrical and symmetrical interference coupled in on lines. The high-frequency portions of the symmetrical data signal are decreased so far that EMC problems can be significantly reduced.

#### Terminals

- Lead-free tinned

#### Marking

Manufacturer, ordering code (short form),  
date of manufacture, coded (year, day of week, calendar week)

#### Delivery mode

Blister tape, reel packing  
For details on taping, packing and packing units see data book 2000 "Chokes and Inductors", page 302



Chokes for Data and Signal Lines

B82790C0\*/K0\*N2

Double Chokes

B82790S0\*/L0\*N2

**SMD**

**Dimensional drawing**

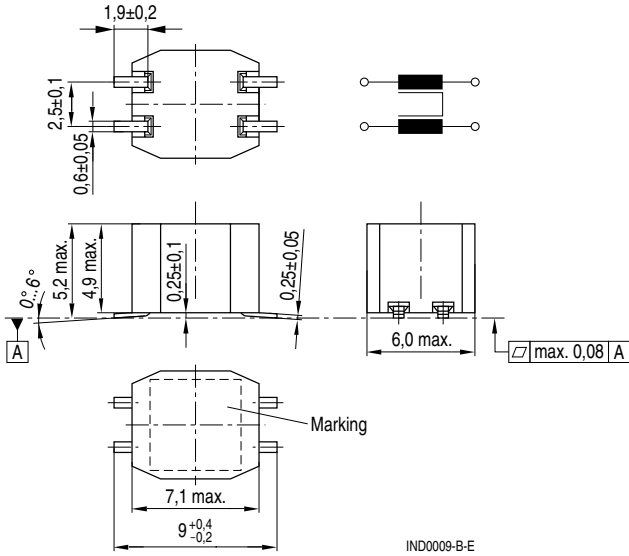

**Layout recommendation**

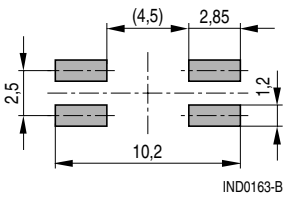

**Chokes for Data and Signal Lines****B82790C0\*/K0\*N2****Double Chokes****B82790S0\*/L0\*N2****SMD****Technical data and measuring conditions**

Rated voltage $V_R$	42 VAC (50/60 Hz) 80 VDC
Rated current $I_R$	Referred to 50 Hz and 60 °C ambient temperature
Rated inductance $L_R$	Measured with HP 4275A at $L \leq 1$ mH = 100 kHz, 0,1 mA $L > 1$ mH = 10 kHz, 0,1 mA (specified per winding)
Inductance tolerance	$L \leq 0,47$ mH: $\pm 30$ % $L > 0,47$ mH: $- 30/+ 50$ %
Inductance decrease $\Delta L/L_0$	$< 10$ % at dc magnetic bias with $I_R$
Stray inductance $L_S$	Measured with HP 4275A. Measuring frequency at $L \leq 11$ $\mu$ H = 1 MHz, 5 mA $L > 11$ $\mu$ H = 100 kHz, 5 mA
DC resistance $R_{typ}$	Typical values, measured at 20 °C ambient temperature
Solderability	(215 $\pm$ 3) °C, (3 $\pm$ 0,3) s wetting of soldering area $\geq 95$ % in accordance with IEC 60068-2-58
Climatic category	40/125/56 (-40 °C/+ 125 °C/56 days damp heat test) in accordance with IEC 60068-1
Weight	Approx. 0,3 g

**Characteristics and ordering codes**

$L_R$ mH	$L_{S, typ}$ nH	$I_R$ mA	$R_{typ}$ m $\Omega$	$V_T$ VDC, 2 s	Ordering code <sup>1)</sup>
0,005	50	1000	100	250	B82790C0502N201
0,011	50	500	120	250	B82790C0113N201
0,025	150	500	130	250	B82790C0253N201
0,025	1500	500	130	250	B82790S0253N201
0,051	200	500	160	250	B82790C0513N201
0,051	2000	500	160	250	B82790S0513N201
0,470	200	500	200	750	B82790C0474N215
1,0	250	500	200	750	B82790C0105N240
2,2	250	400	400	750	B82790C0225N265
4,7	300	200	550	750	B82790C0475N265

1) Special types for conductive adhesion and ambient temperatures of up to 150 °C upon request.



Chokes for Data and Signal Lines

B82790C0\*/K0\*N2

Double Chokes

B82790S0\*/L0\*N2



Insertion loss  $\alpha_e$  (typical values at  $Z = 50 \Omega$ )

———— asymmetrical, all branches in parallel (common mode)

- - - - - symmetrical (differential mode)

$L_R = 0,005 \text{ mH}$

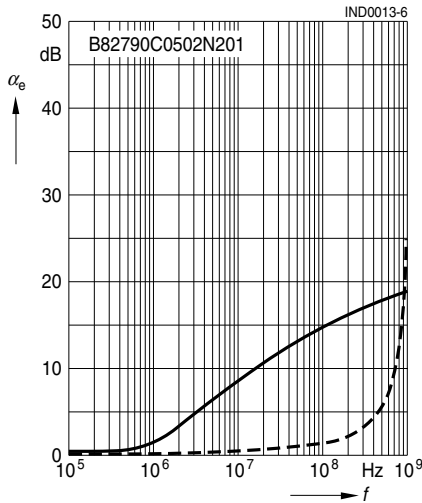

$L_R = 0,011 \text{ mH}$

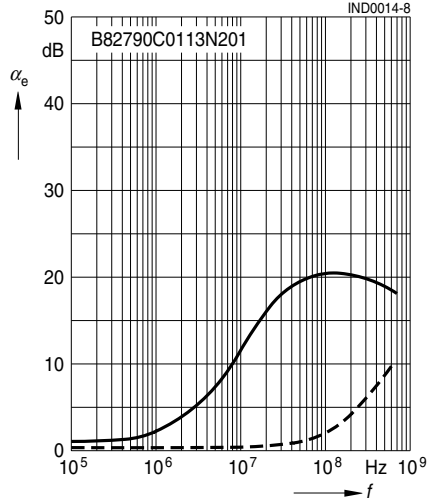

$L_R = 0,025 \text{ mH (low } L_S)$

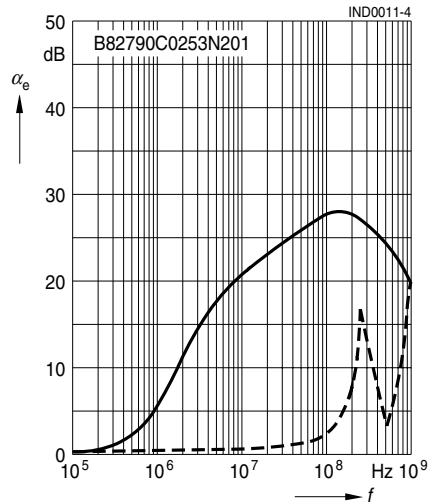

$L_R = 0,025 \text{ mH (high } L_S)$

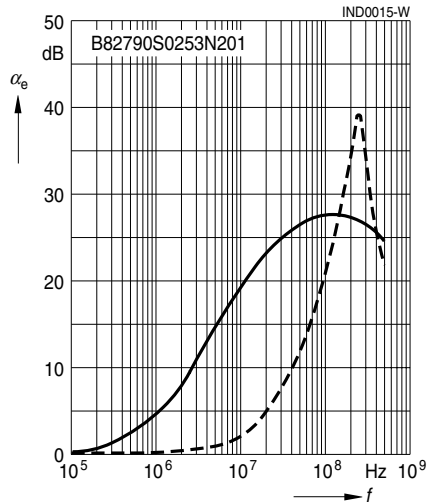



Chokes for Data and Signal Lines

B82790C0\*/K0\*N2

Double Chokes

B82790S0\*/L0\*N2



Insertion loss  $\alpha_e$  (typical values at  $Z = 50 \Omega$ )

———— asymmetrical, all branches in parallel (common mode)

- - - - - symmetrical (differential mode)

$L_R = 0,051 \text{ mH}$  (low  $L_S$ )

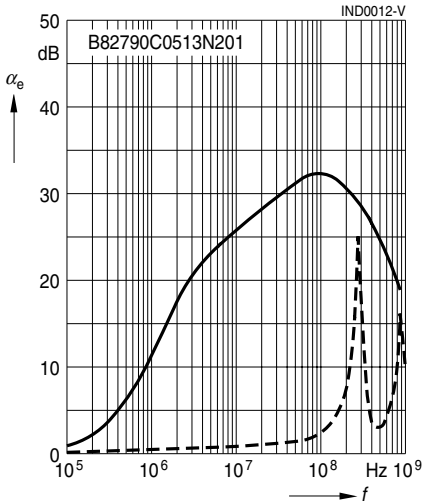

$L_R = 0,051 \text{ mH}$  (high  $L_S$ )

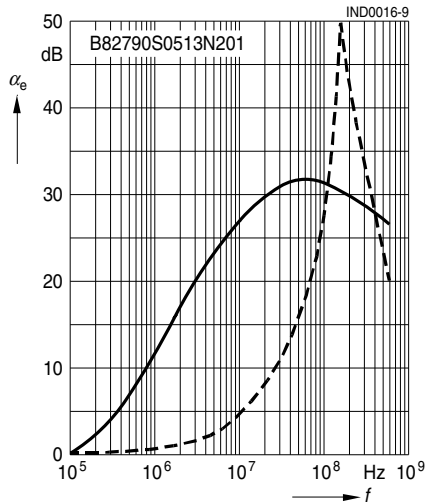

$L_R = 0,47 \text{ mH}$

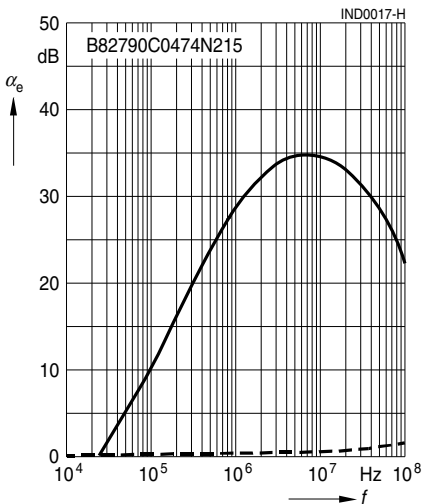

$L_R = 1,0 \text{ mH}$

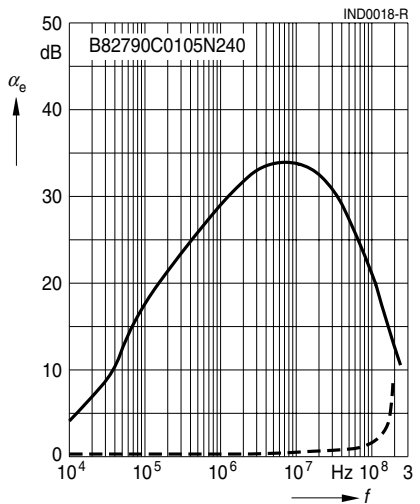



Chokes for Data and Signal Lines

B82790C0\*/K0\*N2

Double Chokes

B82790S0\*/L0\*N2

Insertion loss  $\alpha_e$  (typical values at  $Z = 50 \Omega$ )

———— asymmetrical, all branches in parallel (common mode)

- - - - - symmetrical (differential mode)

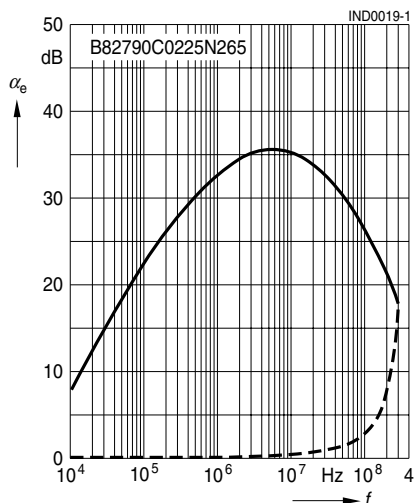
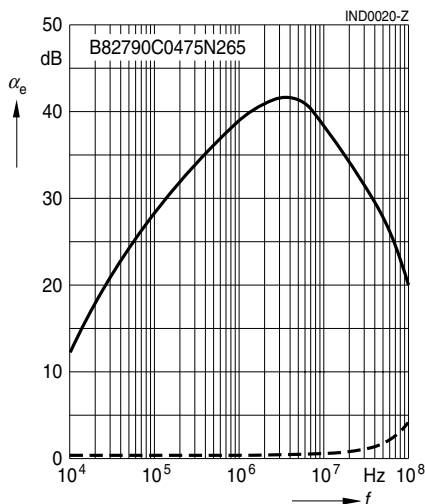
 $L_R = 2,2 \text{ mH}$  $L_R = 4,7 \text{ mH}$ 

Published by EPCOS AG

Corporate Communications, P.O. Box 80 17 09, 81617 Munich, GERMANY

☎ ++49 89 636 09, FAX (0 89) 636-2 26 89

© EPCOS AG 2002. Reproduction, publication and dissemination of this brochure and the information contained therein without EPCOS' prior express consent is prohibited.

Purchase orders are subject to the General Conditions for the Supply of Products and Services of the Electrical and Electronics Industry recommended by the ZVEI (German Electrical and Electronic Manufacturers' Association), unless otherwise agreed.

This brochure replaces the previous edition.

For questions on technology, prices and delivery please contact the Sales Offices of EPCOS AG or the international Representatives.

Due to technical requirements components may contain dangerous substances. For information on the type in question please also contact one of our Sales Offices.