

F  
E  
D  
C  
B  
A

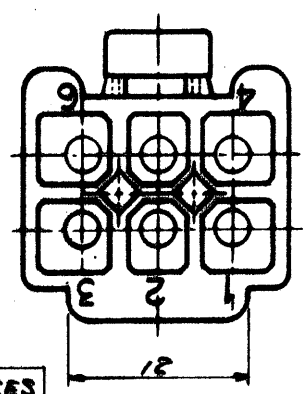
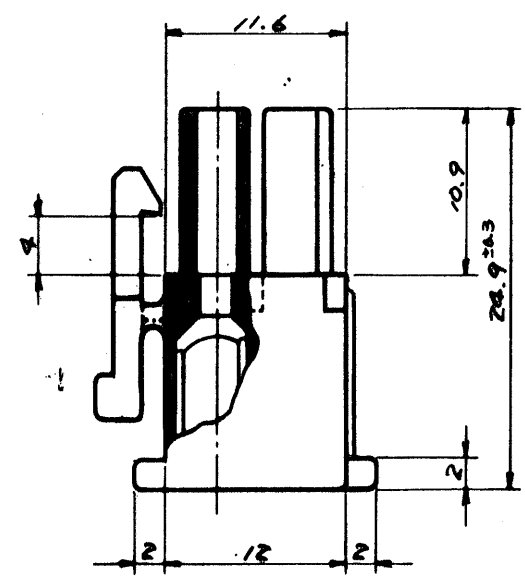
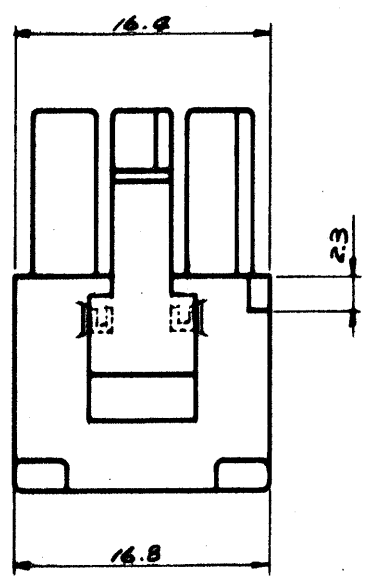
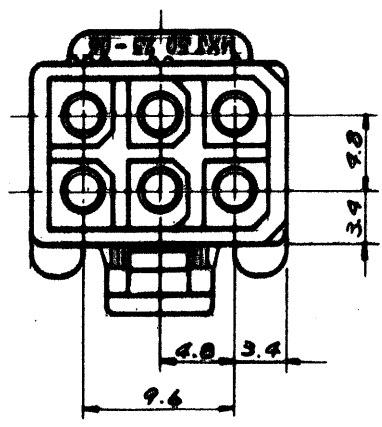

GENERAL TOLERANCES	
10 UNDER	±0.2
20 OVER 30 UNDER	±0.25
30 OVER	±0.3
ANGLE	±5°

			公差 (Tolerances) .000 → ±0.005 .00 → ±0.05 .0 → ±0.1 . → ±0.3		所要数 (Req) ★		DRWG. <i>G. Amano '77 TT</i>	
			材料 (MAT'L) NYLON 66, 94V-2				DSN'D <i>MENDONTO '80/7</i>	
			熱処理 (H.T.) HRc		CHK'D <i>K. S. Shin</i>		APP'D	
D	Qty: 1000	ECN NO. 1486	7/21/77	K.H.	MOLEX-JAPAN CO., LTD. 日本モレックス株式会社		No. SD-5025-06R1	
C	REMOVED 'X' ECN NO. 740		7/21/77	10			REV. $\emptyset$	
B <sub>1</sub>	ロッキン7V7		7/21/77	10				
B	リブ.サーキットNO.		7/21/77	10				
A	REVISED		7/21/77	10				
O	PROPOSED		7/21/77	10				
記号 (LTR)	変更内容 (Rev.)		Date	Name	Scale 2/1	名称 (Name)		MINI. FIT CONN. 6POS. RECEPTACLE HSG.

F  
E  
D  
C  
B  
A

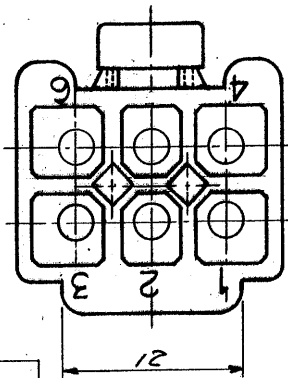
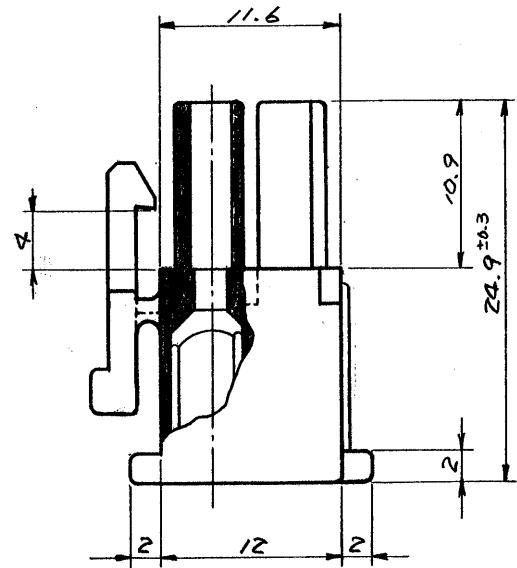
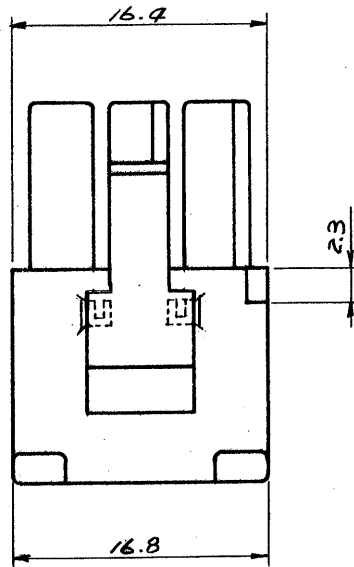
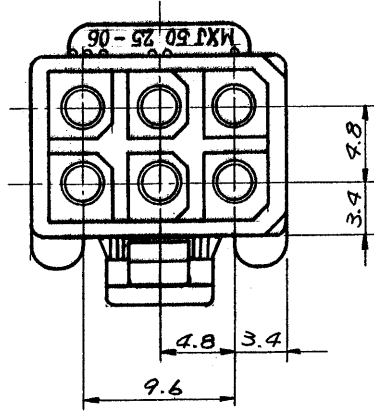

一般公差	
10 未満	±0.2
10以上30未満	±0.25
30 以上	±0.3
角度	±3°

				公差 (Tolerances) .000 → ±0.005 .00 → ±0.05 .0 → ±0.1 . → ±0.3	所要数 (Req) *	DRWG. <i>Y. Awano</i> '9/7 '77	
				材料 (MAT'L) NYLON 66, 94V-2		DSN'D <i>M. ENDO</i> '9/17 '77	
				熱処理 (H.T.) HRc	CHK'D <i>K. S. ...</i>	APP'D <i>W. ...</i>	
⊕	ロッキング支柱 ECN. NO. 1486	11/21/79	<i>K.H.</i>	仕上げ (Finish)	No. <b>SD-5025-06R1</b>	REV. <b>D</b>	
C	REMOVED "X" ECN. NO. 748	3/18/78	<i>M. ...</i>	名称 (Name)		MINI. FIT CONN. 6POS. RECEPTACLE HSG.	
B <sub>1</sub>	ロッキングレバー	3/13/78	<i>M. ...</i>	Scale 2/1			
B	リブ. サークット NO.	12/13/77	<i>M. ...</i>				
A	REVISED	11/15/77	<i>M. ...</i>				
O	PROPOSED	9/7 '77	<i>M. ...</i>				
記号 (LTR)	変更内容 (Rev.)	Date	Name				