

# Cree® XLamp® ML-E LEDs

## Data Sheet

The Cree® XLamp® ML-E LED brings lighting class reliability and performance to 1/2 Watt LEDs. The XLamp ML-E expands Cree’s lighting class leadership to linear and distributed lighting applications. With XLamp lighting class reliability, a wide viewing angle, uniform light output, and industry leading chromaticity binning in a 3.5mm X 3.5 mm package, the XLamp ML-E LED continues Cree’s history of segment-focused product innovation in LEDs for lighting applications.



The XLamp ML-E LED brings high performance and a smooth look to a wide range of lighting applications, including linear lighting, LED light bulbs, fluorescent retrofits and retail-display lighting.

### FEATURES

- Available in white (2,600 K to 8,300 K CCT)
- ANSI-compatible sub-bins
- Maximum Drive current: 175 mA
- 120° viewing angle, uniform chromaticity profile
- Electrically neutral thermal path
- RoHS and Reach-compliant
- Unlimited floor life at  $\leq 30^{\circ}\text{C}/85\% \text{ RH}$

### Table of Contents

Flux Characteristics ( $T_j = 25^{\circ}\text{C}$ ).....	2
Characteristics .....	2
Relative Spectral Power Distribution .....	3
Relative Flux vs. Junction Temperature ( $I_f = 150 \text{ mA}$ ).....	3
Electrical Characteristics ( $T_j = 25^{\circ}\text{C}$ ) .....	4
Relative Flux vs. Current ( $T_j = 25^{\circ}\text{C}$ ) .....	4
Thermal Design.....	5
Typical Spatial Distribution.....	5
Reflow Soldering Characteristics .....	6
Notes.....	7
Mechanical Dimensions ( $T_A = 25^{\circ}\text{C}$ ) .....	8
Tape and Reel .....	9
Packaging.....	10



## Flux Characteristics (T<sub>j</sub> = 25°C)

The following table provides several base order codes for XLamp ML-E LEDs. It is important to note that the base order codes listed here are a subset of the total available order codes for the product family. For more order codes, as well as a complete description of the order-code nomenclature, please consult the XLamp ML-E LED Binning and Labeling document.

Color	CCT Range		Base Order Codes Min Luminous Flux (lm) @ 150 mA		Order Code
	Min.	Max.	Group	Flux (lm)	
Cool White	5,000 K	8,300 K	M2	39.8	MLEAWT-A1-0000-000251
			M3	45.7	MLEAWT-A1-0000-000351
			N2	51.7	MLEAWT-A1-0000-000451
Warm White	3,700 K	4,300 K	M2	39.8	MLEAWT-A1-0000-0002E5
			M3	45.7	MLEAWT-A1-0000-0003E5
	2,800 K	3,200 K	K2	30.6	MLEAWT-A1-0000-0000E7
			K3	35.2	MLEAWT-A1-0000-0001E7

### Notes:

- Cree maintains a tolerance of +/- 7% on flux measurements.
- Typical CRI for Cool White (4,300 K – 8,300 K CCT) is 75.
- Typical CRI for Warm White (2,600 K – 4,300 K CCT) is 80.

## Characteristics

Characteristics	Unit	Minimum	Typical	Maximum
Thermal resistance, junction to solder point	°C/W		11	
Viewing angle (FWHM)	degrees		120	
Temperature coefficient of voltage	mV/°C		-3	
ESD classification (HBM per Mil-Std-883D)			Class 2	
DC forward current	mA		150	175
Forward voltage (@ 150 mA)	V		3.2	3.4
LED junction temperature	°C			150

## Relative Spectral Power Distribution

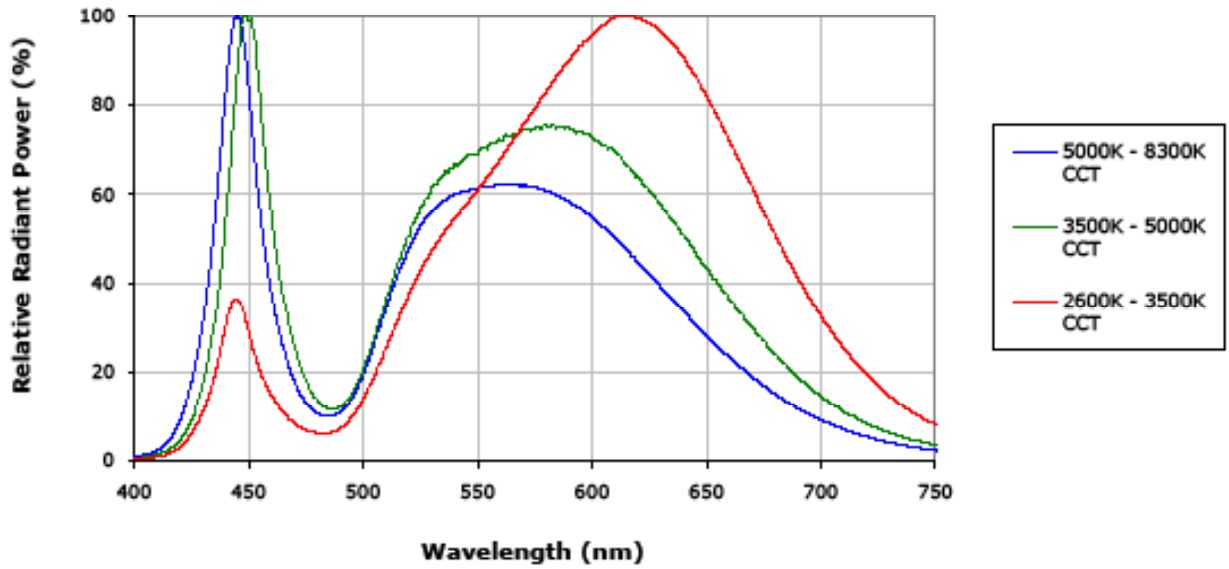

## Relative Flux vs. Junction Temperature ( $I_f = 150$ mA)

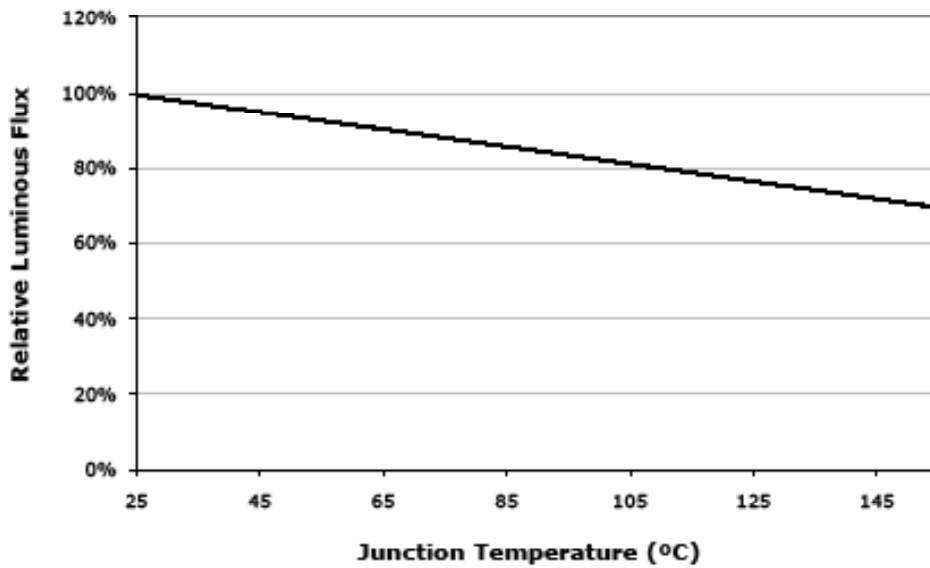



## Electrical Characteristics ( $T_j = 25^\circ\text{C}$ )

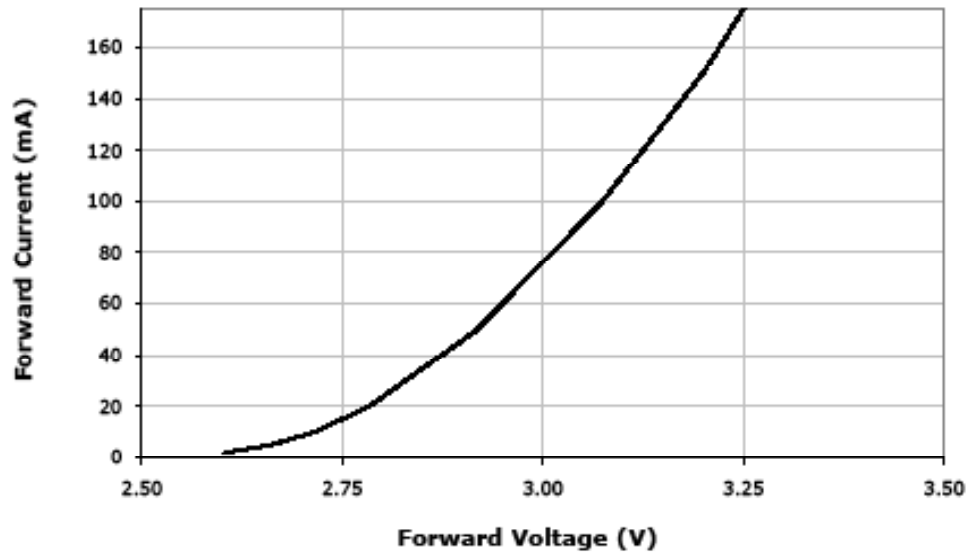

## Relative Flux vs. Current ( $T_j = 25^\circ\text{C}$ )

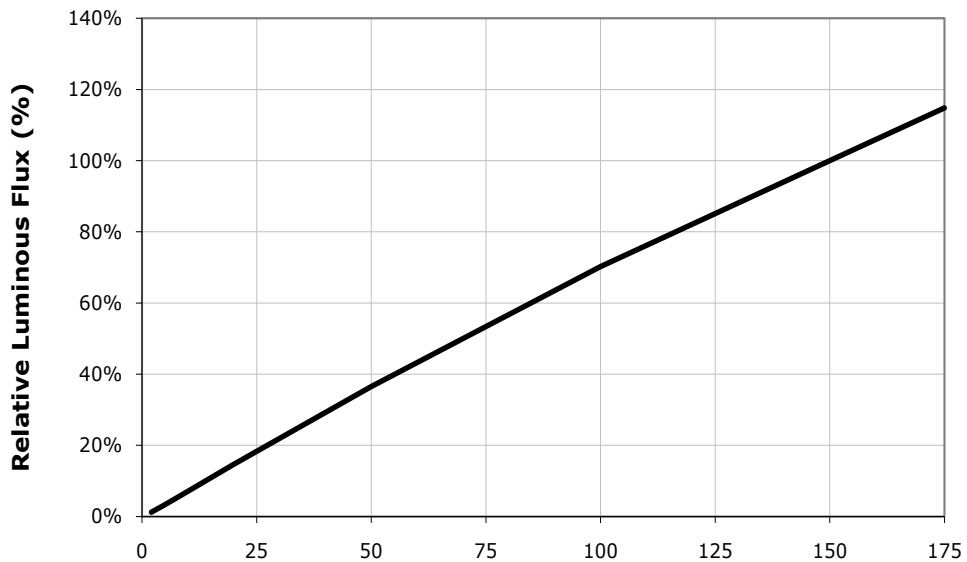

## Thermal Design

The maximum forward current is determined by the thermal resistance between the LED junction and ambient. It is crucial for the end product to be designed in a manner that minimizes the thermal resistance from the solder point to ambient in order to optimize lamp life and optical characteristics.

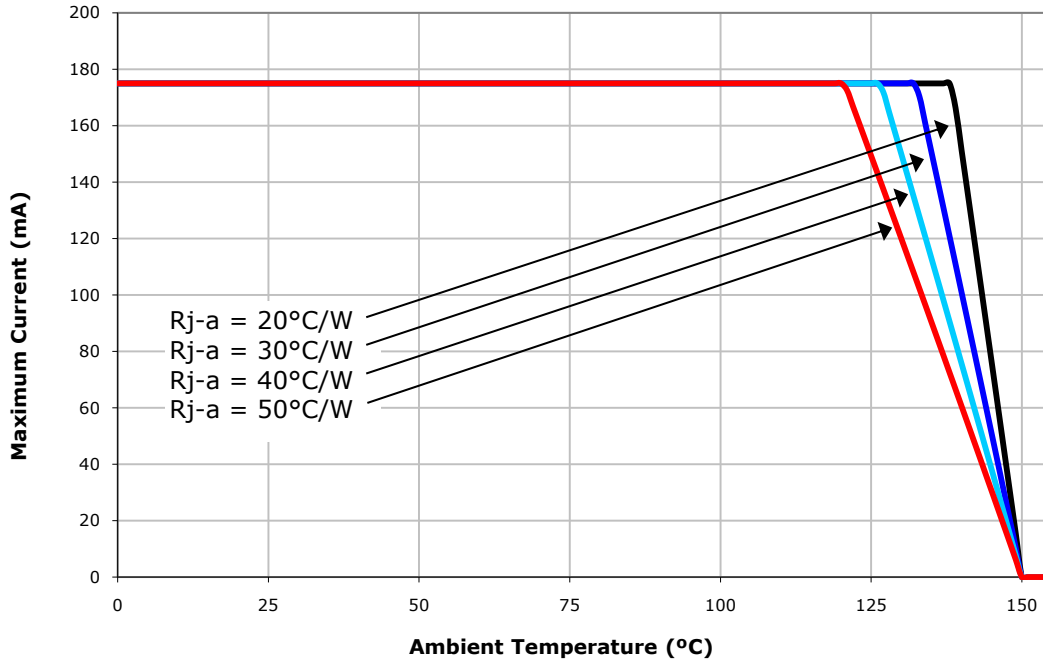

## Typical Spatial Distribution

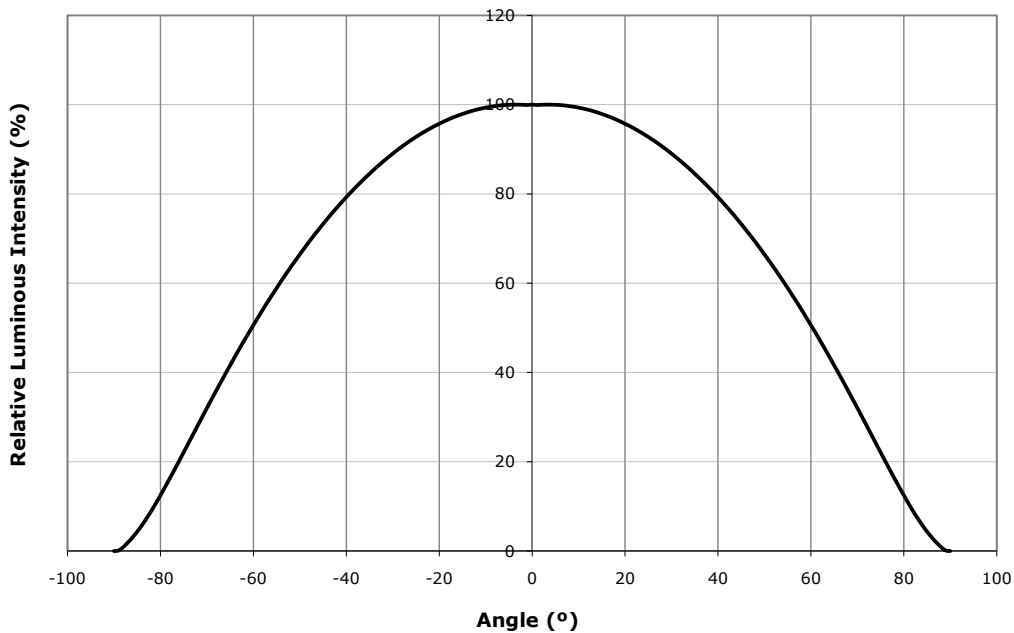

## Reflow Soldering Characteristics

In testing, Cree has found XLamp ML-E LEDs to be compatible with JEDEC J-STD-020C, using the parameters listed below. As a general guideline, Cree recommends that users follow the recommended soldering profile provided by the manufacturer of solder paste used.

Note that this general guideline may not apply to all PCB designs and configurations of reflow soldering equipment.

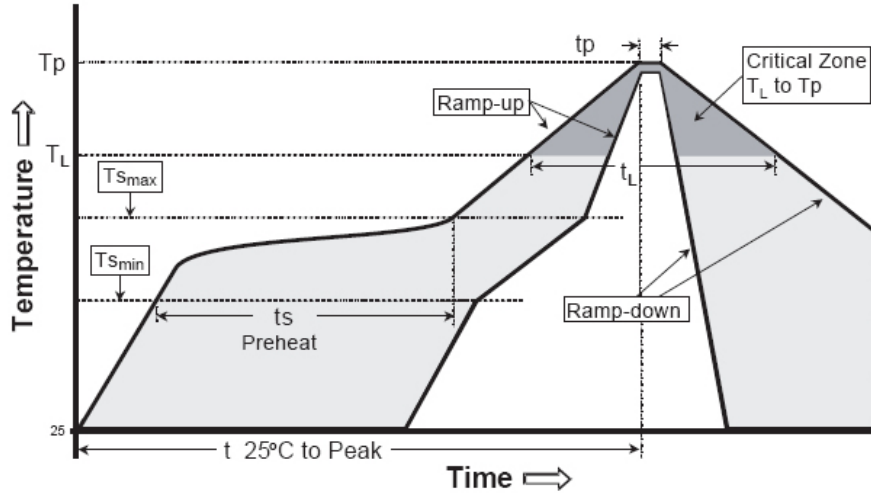

Profile Feature	Lead-Based Solder	Lead-Free Solder
Average Ramp-Up Rate ( $T_{s_{max}}$ to $T_p$ )	3°C/second max.	3°C/second max.
Preheat: Temperature Min ( $T_{s_{min}}$ )	100°C	150°C
Preheat: Temperature Max ( $T_{s_{max}}$ )	150°C	200°C
Preheat: Time ( $t_{s_{min}}$ to $t_{s_{max}}$ )	60-120 seconds	60-180 seconds
Time Maintained Above: Temperature ( $T_L$ )	183°C	217°C
Time Maintained Above: Time ( $t_L$ )	60-150 seconds	60-150 seconds
Peak/Classification Temperature ( $T_p$ )	215°C	260°C
Time Within 5°C of Actual Peak Temperature ( $t_p$ )	10-30 seconds	20-40 seconds
Ramp-Down Rate	6°C/second max.	6°C/second max.
Time 25°C to Peak Temperature	6 minutes max.	8 minutes max.

Note: All temperatures refer to topside of the package, measured on the package body surface.

Note: While the high reflow temperatures (above) have been approved, Cree’s best practice guideline for reflow is to use as low a temperature as possible during the reflow soldering process for these LEDs.



## Notes

---

### Moisture Sensitivity

In testing, Cree has found XLamp ML-E LEDs to have unlimited floor life in conditions  $\leq 30^{\circ}\text{C}$  / 85% relative humidity (RH). Moisture testing included a 168 hour soak at  $85^{\circ}\text{C}$  / 85% RH followed by 3 reflow cycles, with visual and electrical inspections at each stage.

### RoHS Compliance

The levels of environmentally sensitive, persistent biologically toxic (PBT), persistent organic pollutants (POP), or otherwise restricted materials in this product are below the maximum concentration values (also referred to as the threshold limits) permitted for such substances, or are used in an exempted application, in accordance with EU Directive 2002/95/EC on the restriction of the use of certain hazardous substances in electrical and electronic equipment (RoHS), as amended through April 21, 2006.

### Vision Advisory Claim

Users should be cautioned not to stare at the light of this LED product. The bright light can damage the eye.

# Mechanical Dimensions ( $T_A = 25^\circ\text{C}$ )

All measurements are  $\pm 0.13$  mm unless otherwise indicated.

Top View

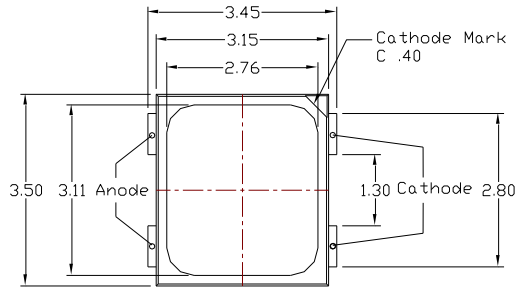
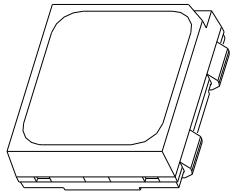

Top View

Bottom View

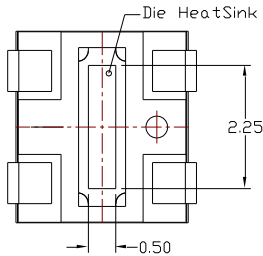

Side View

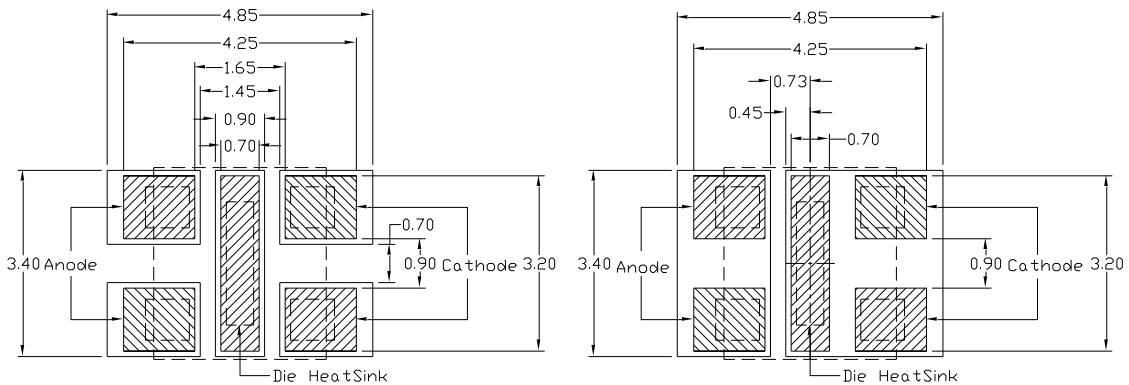
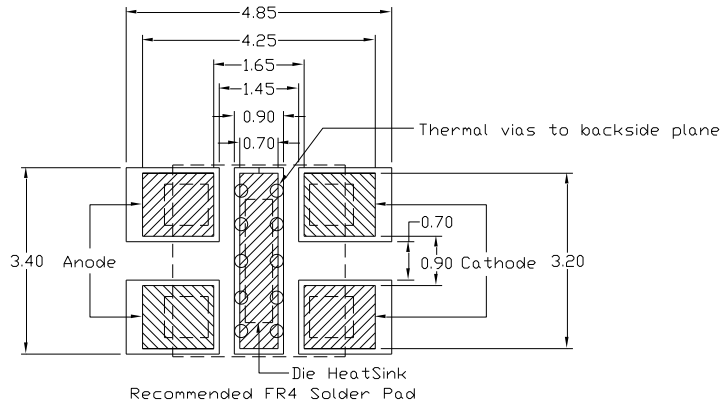
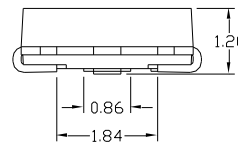

Recommended MPCB Solder Pad

Alternative Solder Pad



# Tape and Reel

All dimensions in mm.

