

General Description

KEC Field Stop Trench IGBTs offer low switching losses, high energy efficiency and short circuit ruggedness.

It is designed for applications such as motor control, uninterrupted power supplies(UPS), general inverters.

FEATURES

- High speed switching
- High ruggedness, temperature stable behavior
- Short Circuit Withstand Times 10us
- Extremely enhanced avalanche capability

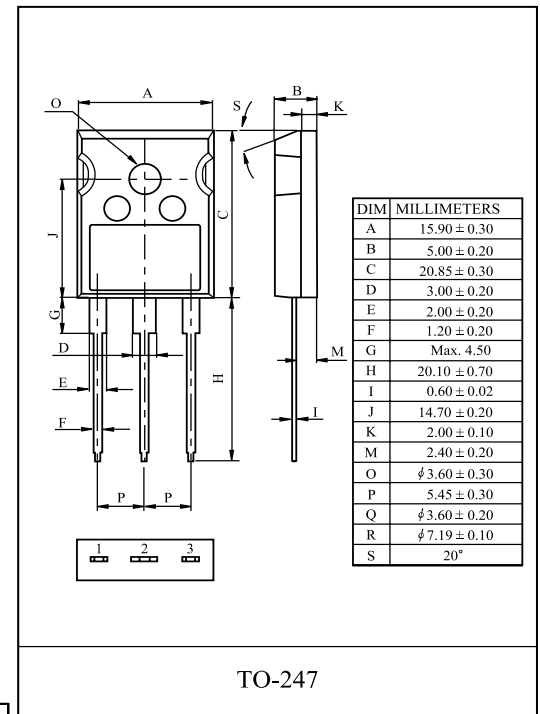

MAXIMUM RATING (Ta=25 °C)

CHARACTERISTIC	SYMBOL	RATING	UNIT
Collector-Emitter Voltage	V_{CES}	1200	V
Gate-Emitter Voltage	V_{GES}	± 20	V
Collector Current	I_C	@Tc=25	50 A
		@Tc=100	25 A
Pulsed Collector Current	I_{CM}^*	75	A
Diode Continuous Forward Current	@Tc=100	I_F	25 A
Diode Maximum Forward Current		I_{FM}	75 A
Maximum Power Dissipation	P_D	@Tc=25	227 W
		@Tc=100	91 W
Maximum Junction Temperature	T_j	150	
Storage Temperature Range	T_{stg}	-55 to + 150	

*Repetitive rating : Pulse width limited by max. junction temperature

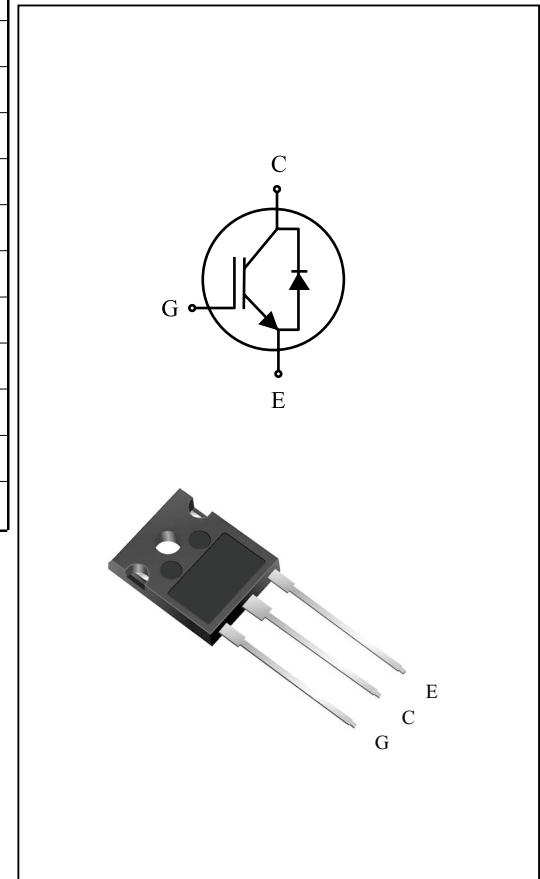

THERMAL CHARACTERISTIC

CHARACTERISTIC	SYMBOL	MAX.	UNIT
Thermal Resistance, Junction to Case (IGBT)	R_{thJC}	0.55	/W
Thermal Resistance, Junction to Case (DIODE)	R_{thJC}	1.7	/W
Thermal Resistance, Junction to Ambient	R_{thJA}	40	/W

KGF25N120KDA

ELECTRICAL CHARACTERISTICS (Ta=25)

CHARACTERISTIC	SYMBOL	TEST CONDITION	MIN.	TYP.	MAX.	UNIT	
Static							
Collector-Emitter Breakdown Voltage	BV_{CES}	$V_{GE}=0V, I_C=1mA$	1200	-	-	V	
Collector Cut-off Current	I_{CES}	$V_{GE}=0V, V_{CE}=1200V$	-	-	1.0	mA	
Gate Leakage Current	I_{GES}	$V_{CE}=0V, V_{GE}=\pm 20V$	-	-	± 100	nA	
Gate Threshold Voltage	$V_{GE(th)}$	$V_{GE}=V_{CE}, I_C=25mA$	4.5	5.5	7.0	V	
Collector-Emitter Saturation Voltage	$V_{CE(sat)}$	$V_{GE}=15V, I_C=25A$	-	2.0	2.4	V	
		$V_{GE}=15V, I_C=25A, T_C = 125$	-	2.25	-	V	
		$V_{GE}=15V, I_C=50A$	-	2.6	-	V	
Dynamic							
Total Gate Charge	Q_g	$V_{CC}=600V, V_{GE}=15V, I_C= 25A$	-	160	-	nC	
Gate-Emitter Charge	Q_{ge}		-	25	-	nC	
Gate-Collector Charge	Q_{gc}		-	80	-	nC	
Turn-On Delay Time	$t_{d(on)}$	$V_{CC}=600V, I_C=25A, V_{GE}=15V, R_G=10$ Inductive Load, $T_C = 25$	-	40	-	ns	
Rise Time	t_r		-	25	-	ns	
Turn-Off Delay Time	$t_{d(off)}$		-	175	-	ns	
Fall Time	t_f		-	85	-	ns	
Turn-On Switching Loss	E_{on}		-	1.85	2.4	mJ	
Turn-Off Switching Loss	E_{off}		-	0.9	1.2	mJ	
Total Switching Loss	E_{ts}		-	2.75	3.6	mJ	
Turn-On Delay Time	$t_{d(on)}$		$V_{CC}=600V, I_C=25A, V_{GE}=15V, R_G=10$ Inductive Load, $T_C = 125$	-	40	-	ns
Rise Time	t_r			-	30	-	ns
Turn-Off Delay Time	$t_{d(off)}$			-	180	-	ns
Fall Time	t_f	-		190	-	ns	
Turn-On Switching Loss	E_{on}	-		2.0	-	mJ	
Turn-Off Switching Loss	E_{off}	-		1.6	-	mJ	
Total Switching Loss	E_{ts}	-		3.6	-	mJ	
Input Capacitance	C_{ies}	$V_{CE}=30V, V_{GE}=0V, f=1MHz$	-	2650	3450	pF	
Output Capacitance	C_{oes}		-	115	-	pF	
Reverse Transfer Capacitance	C_{res}		-	70	-	pF	
Short Circuit Withstand Time	t_{sc}		$V_{CC}=600V, V_{GE}=15V, T_C=100$	10	-	-	μs

Marking

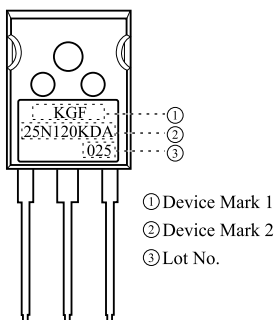

KGF25N120KDA

ELECTRICAL CHARACTERISTIC OF DIODE

CHARACTERISTIC	SYMBOL	TEST CONDITION		MIN.	TYP.	MAX.	UNIT
Diode Forward Voltage	V_F	$I_F = 25A$	$T_C = 25$	-	2.4	3.0	V
			$T_C = 125$	-	2.5	-	
Diode Reverse Recovery Time	t_{rr}	$I_F = 25A$	$T_C = 25$	-	140	-	ns
			$T_C = 125$	-	180	-	
Diode Peak Reverse Recovery Current	I_{rr}	$I_F = 25A$ $di/dt = 200A/\mu s$	$T_C = 25$	-	13.5	-	A
			$T_C = 125$	-	16.0	-	
Diode Reverse Recovery Charge	Q_{rr}	$I_F = 25A$ $di/dt = 200A/\mu s$	$T_C = 25$	-	1.05	-	μC
			$T_C = 125$	-	1.65	-	

KGF25N120KDA

Fig 1. Saturation Voltage Characteristics

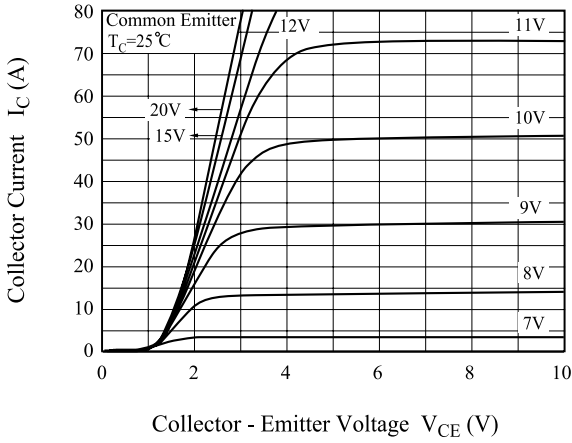

Fig 2. Saturation Voltage Characteristics

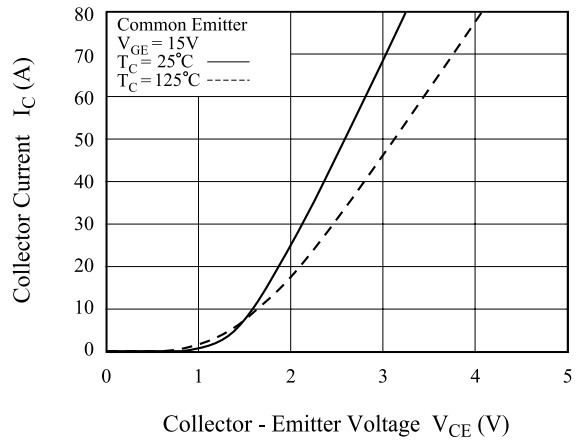

Fig 3. Saturation Voltage vs. Case Temperature

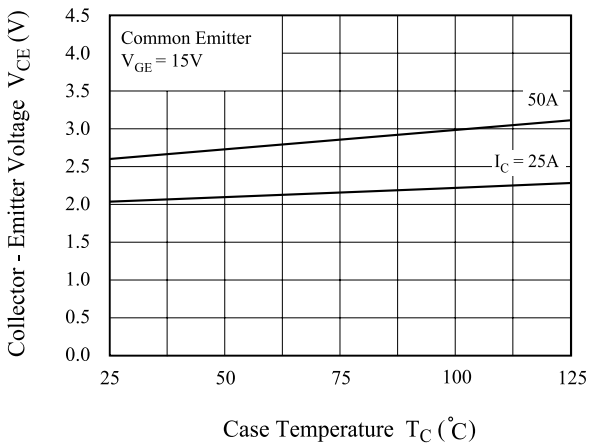

Fig 4. Saturation Voltage vs. V_{GE}

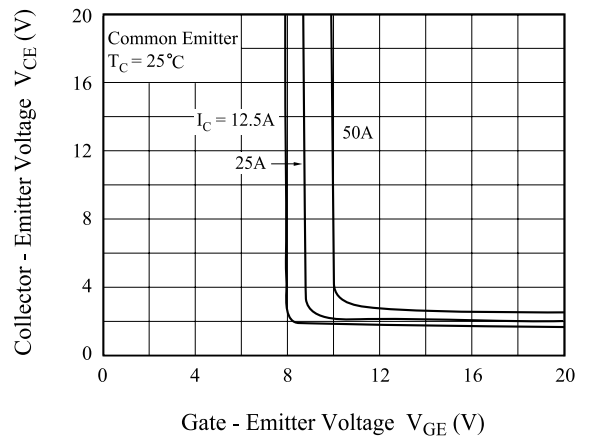

Fig 5. Saturation Voltage vs. V_{GE}

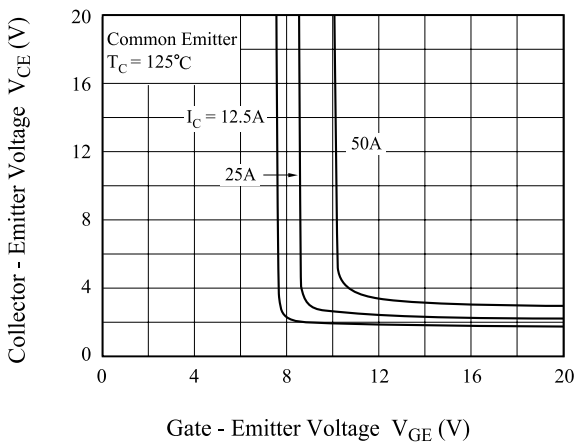
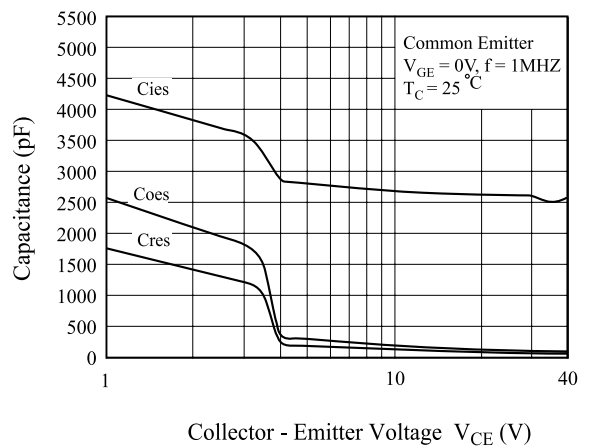

Fig 6. Capacitance Characteristics



KGF25N120KDA

Fig 7. Turn-On Characteristics vs. Gate Resistance

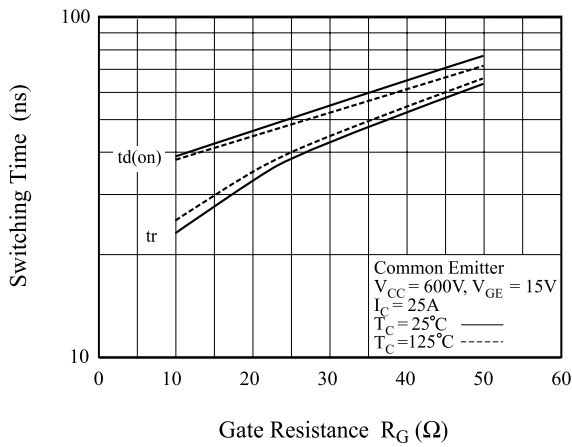

Fig 8. Turn-Off Characteristics vs. Gate Resistance

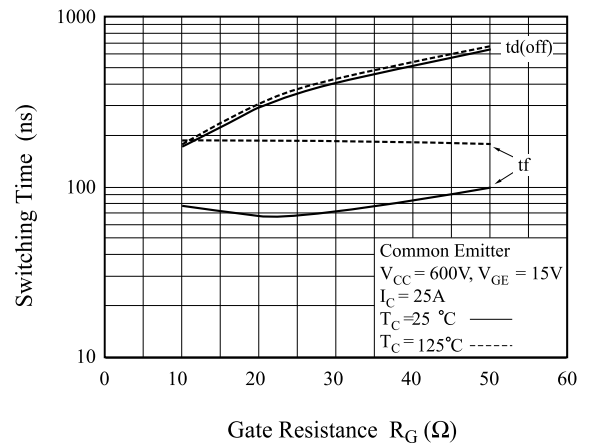

Fig 9. Switching Loss vs. Gate Resistance

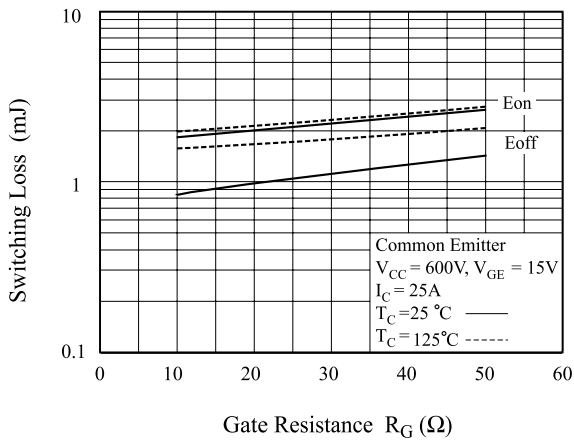

Fig 10. Turn-On Characteristics vs. Collector Current

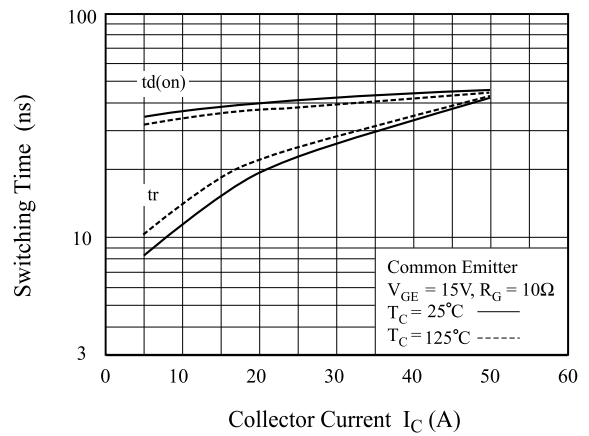

Fig 11. Turn-Off Characteristics vs. Collector Current

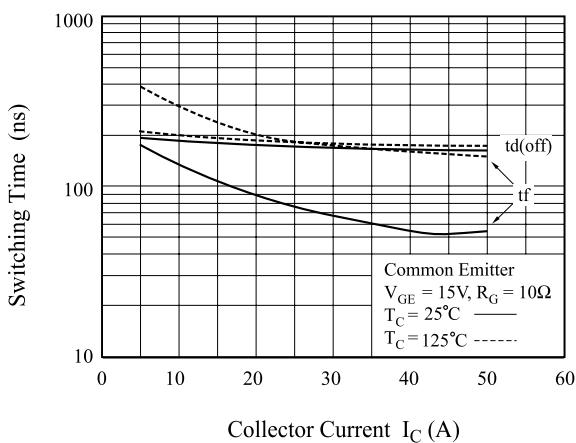
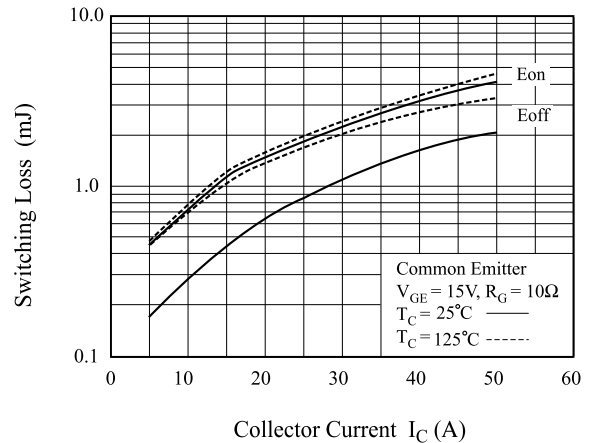

Fig 12. Switching Loss vs. Collector Current



KGF25N120KDA

Fig 13. Gate Charge Characteristics

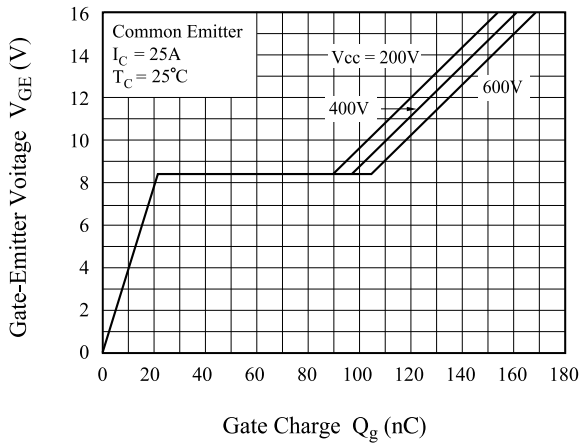

Fig 14. SOA Characteristics

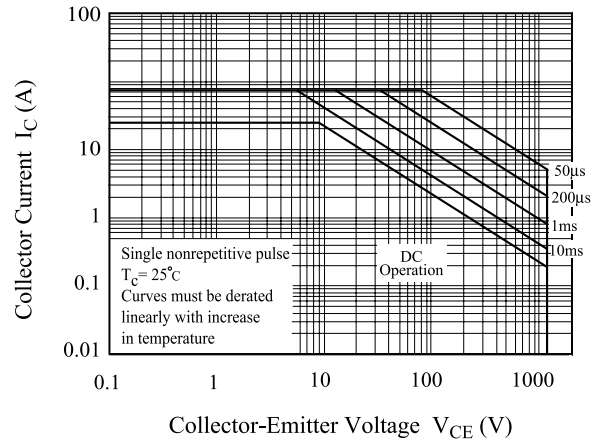

Fig 15. Turn-Off SOA

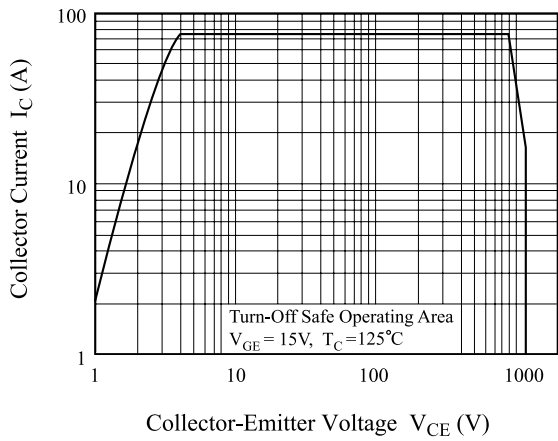
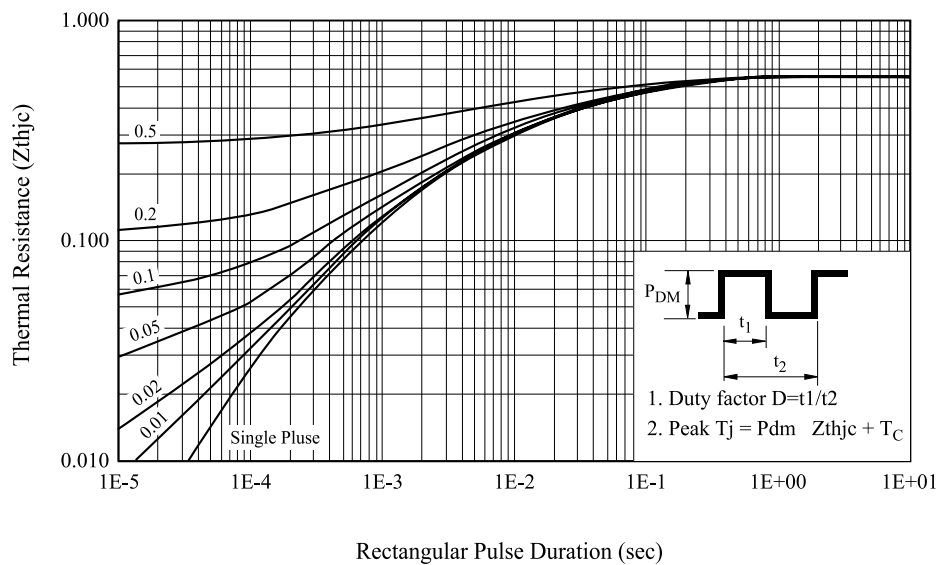

Fig 16. Transient Thermal Impedance of IGBT



KGF25N120KDA

Fig 17. Forward Characteristics

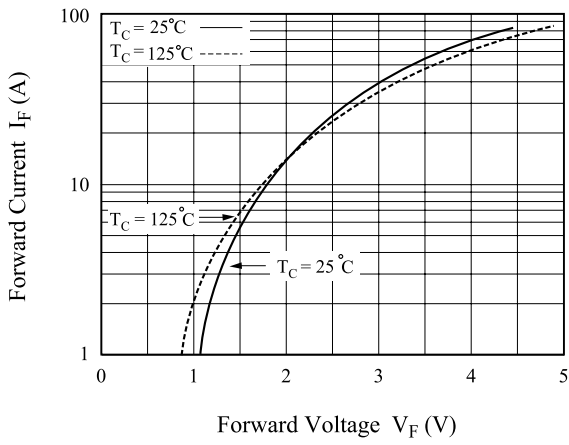

Fig 18. Reverse Recovery Current

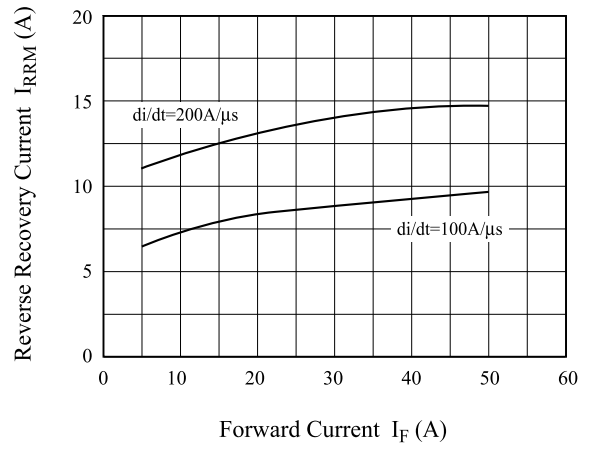
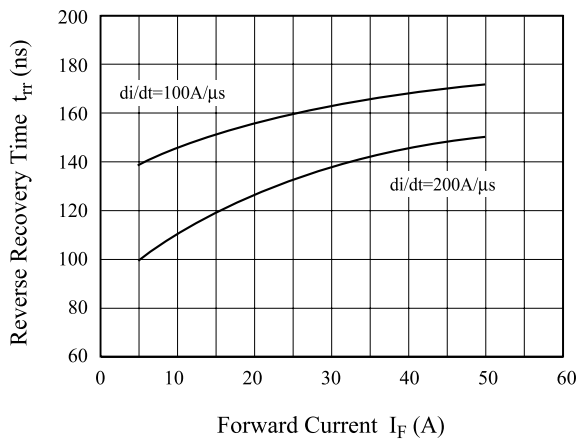

Fig 19. Reverse Recovery Time



KGF25N120KDA

Fig 20. Switching Test Circuit

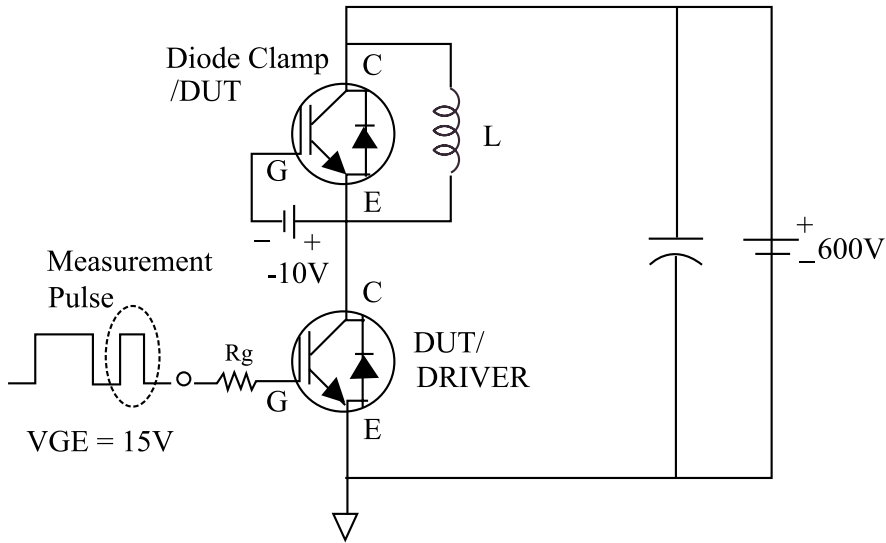

Fig 21. Definition Switching Time & Loss

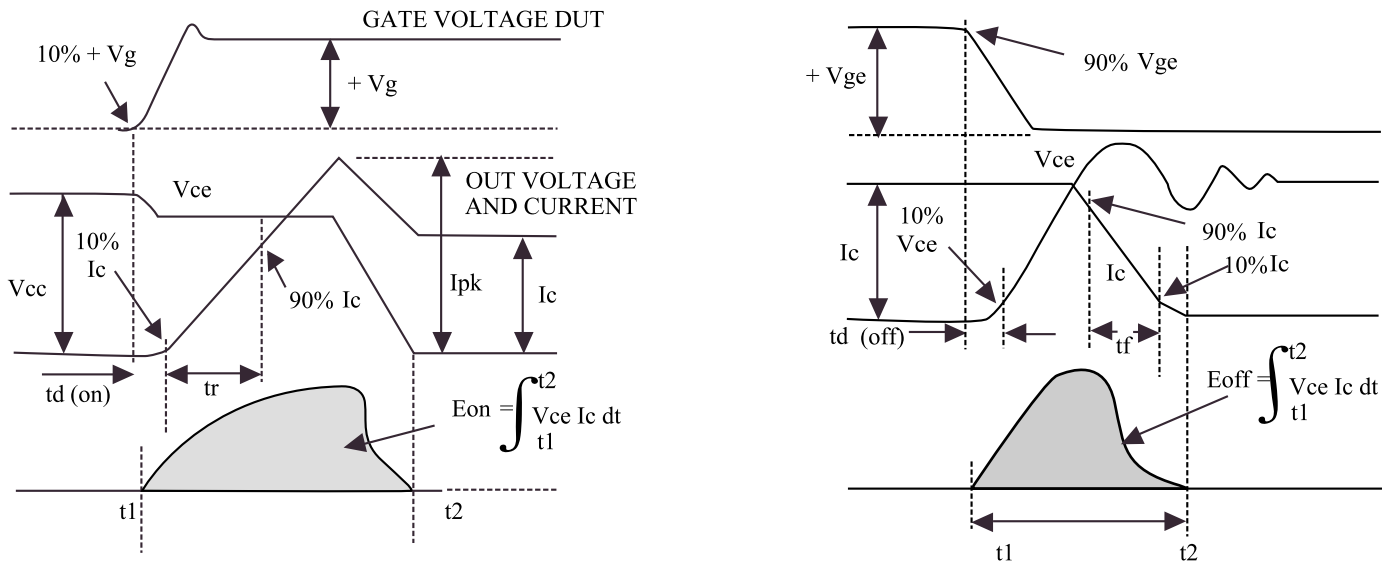

Fig 22. Definition Diode Switching Time

