

PLEASE CHECK WWW.MOLEX.COM FOR LATEST PART INFORMATION

Part Number: [0026033171](#)
Status: **Active**
Overview: [kk](#)
Description: 3.96mm (.156") Pitch KK® Crimp Terminal Housing - Use With Trifurcon® Terminals, 17 Circuits

Documents:

[3D Model](#) [Product Specification PS-40-02 \(PDF\)](#)
[Drawing \(PDF\)](#) [RoHS Certificate of Compliance \(PDF\)](#)

Agency Certification

CSA LR19980

General

Product Family Crimp Housings
 Series [6442](#)
 Overview [kk](#)
 Product Name KK®

Physical

Circuits (maximum) 17
 Color - Resin Natural
 Flammability 94V-2
 Gender Female
 Glow-Wire Compliant No
 Material - Resin Nylon
 Number of Rows 1
 Packaging Type Bag
 Panel Mount No
 Pitch - Mating Interface (in) 0.156 In
 Pitch - Mating Interface (mm) 3.96 mm
 Stackable No
 Temperature Range - Operating 0°C to +75°C

Material Info

Old Part Number 6442-17-Z

Reference - Drawing Numbers

Product Specification PS-40-02
 Sales Drawing SD-6442

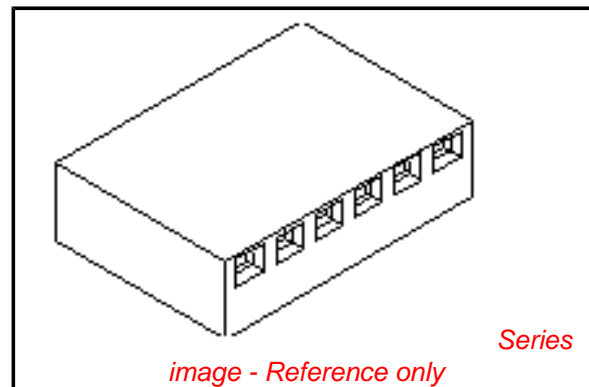

EU RoHS

ELV and RoHS Compliant
REACH SVHC Contains SVHC: No
Halogen-Free Status
Not Reviewed

China RoHS



Need more information on product environmental compliance?

Email productcompliance@molex.com
 For a multiple part number RoHS Certificate of Compliance, [click here](#)

Please visit the [Contact Us](#) section for any non-product compliance questions.

Search Parts in this Series

[6442Series](#)

Mates With

Molex 3.96mm (.156") pitch KK® headers

Use With

[6838](#) and [7258](#) KK® Trifurcon crimp terminals

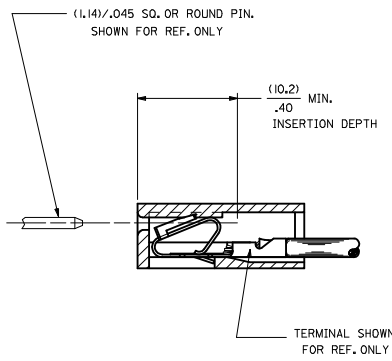
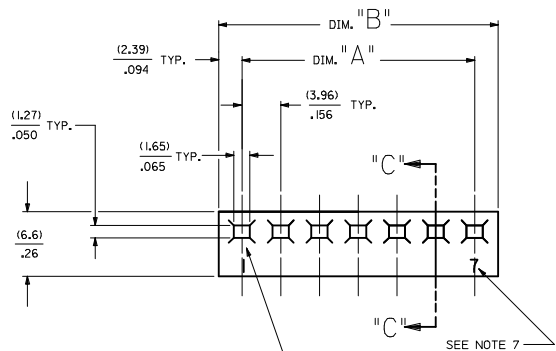

SECTION "C-C"

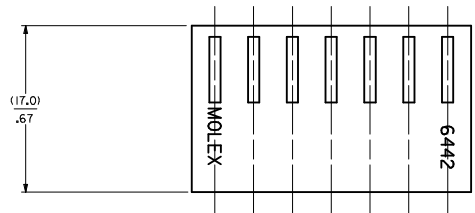

NO. OF CKT'S.	DIM. A	DIM. B
1	-----	(4.78+.18)
2	(3.96+.13)	(8.74+.18)
3	.156+.005	.344+.007
4	(7.92+.13)	(12.70+.18)
5	.312+.005	.500+.007
6	(11.89+.13)	(16.66+.18)
7	.468+.005	.656+.007
8	(15.85+.13)	(20.62+.18)
9	.624+.005	.812+.007
10	(19.81+.13)	(24.59+.18)
11	.780+.005	.968+.007
12	(23.77+.13)	(28.55+.18)
13	.936+.005	1.124+.007
14	(27.74+.25)	(32.51+.30)
15	1.092+.010	1.280+.012
16	(31.70+.25)	(36.47+.30)
17	1.248+.010	1.436+.012
18	(35.66+.25)	(40.44+.30)
19	1.404+.010	1.592+.012
20	(39.62+.25)	(44.40+.30)
21	1.560+.010	1.748+.012
22	(43.59+.25)	(48.36+.30)
23	1.716+.010	1.904+.012
24	(47.55+.30)	(52.32+.36)
	1.872+.012	2.060+.014
	(51.51+.36)	(56.29+.41)
	2.028+.014	2.216+.016
	(55.47+.36)	(60.25+.41)
	2.184+.014	2.372+.016
	(59.44+.36)	(64.21+.41)
	2.340+.014	2.528+.016
	(63.40+.36)	(68.17+.41)
	2.496+.014	2.684+.016
	(67.36+.36)	(72.14+.41)
	2.652+.014	2.840+.016
	(71.32+.36)	(76.10+.41)
	2.808+.014	2.996+.016
	(75.29+.46)	(80.06+.51)
	2.964+.018	3.152+.020
	(79.25+.46)	(84.02+.51)
	3.120+.018	3.308+.020
	(83.21+.46)	(87.99+.51)
	3.276+.018	3.464+.020
	(87.17+.46)	(91.95+.51)
	3.432+.018	3.620+.020
	(91.14+.46)	(95.91+.51)
	3.588+.018	3.776+.020

- NOTES:
1. MATERIAL A: NYLON 6/6 UL94V-2. COLOR: NATURAL
 2. FINISH: N/A
 3. THIS PART COMPLIES WITH PRODUCT SPECIFICATION PS-40-02.
 4. SEE SHEET 2 FOR OPTIONS.
 5. HOUSING SHOWN ABOVE IS STANDARD HOUSING WITH NO OPTIONS.
 6. THIS HOUSING FOR USE WITH TERMINAL NO.,
6438-N, (18-22 GA) WITH (2.79)/.110 MAX. INSULATION DIA.
6838-N, (18-24 GA) WITH (2.79)/.110 MAX. INSULATION DIA.
7258-N, (22-26 GA) WITH (1.65)/.065 MAX. INSULATION DIA.
 7. CIRCUIT SIZE MOLDED ON 4 THRU 24 CIRCUIT HOUSINGS ONLY.
 8. THIS PART CONFORMS TO CLASS B REQUIREMENTS OF COSMETIC SPECIFICATION PS-45499-002.

HOUSING OPTIONS

CODE	HOOKS	SIDE HOOKS	RAMP
BLANK	NONE	NONE	NONE
A	NONE	YES	NONE
R	NONE	NONE	FRICITION
B	NONE	NONE	TYPE B
C	NONE	NONE	TYPE C

6442- * N - * - * - *

VOLTAGE RATING OPTION
BLANK=NONE
V= '250 VAC' ON HOUSING

MAT'L OPTION
BLANK= MATERIAL A (SEE NOTE 1)

MOLDED VOID CODE
Z=NO VOIDS
A=CKT. 1 VOID,
B=CKT. 2 VOID, ETC.
51=1ST MULTIPLE VOID,
52=2ND MULTIPLE VOID, ETC.

NO. OF CKT'S.

REMOVE D OPTION EC NO: UCP2009-3148 DRAWN/KIPER 2009/07/13 CHKD/SOUSEK 2009/07/13 APPR/FSMTH 2009/08/05	QUALITY SYMBOLS	GENERAL TOLERANCES (UNLESS SPECIFIED)	DIMENSION STYLE	SCALE	DESIGN UNITS	THIRD ANGLE PROJECTION
	4 PLACES ± --- ± --- 3 PLACES ± --- ± .010 2 PLACES ± 0.25 ± .014 1 PLACE ± 0.36 ± --- ANGULAR ±1/2°	mm INCH	MM/IN	DATE	INCH	INCH
			DRAWN BY POLGAR 1986/12/03			TITLE
			CHECKED BY PATEL 1986/12/03			KK (3.96)/.156 TRIFURCON CRIMP TERMINAL HOUSING 6442 SERIES
			APPROVED BY ENZ 1986/12/03			MOLEX INCORPORATED
			MATERIAL NO. SEE CHART			DOCUMENT NO. SD-6442
			DRAFT WHERE APPLICABLE MUST REMAIN WITHIN DIMENSIONS			SHEET NO. 1 OF 4
			SIZE D THIS DRAWING CONTAINS INFORMATION THAT IS PROPRIETARY TO MOLEX INCORPORATED AND SHOULD NOT BE USED WITHOUT WRITTEN PERMISSION			

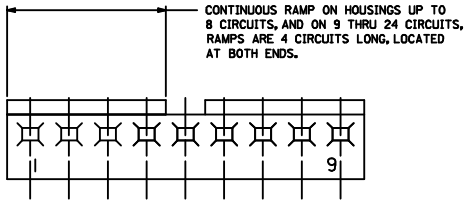

STD. RAMP OPTION CODE "R"

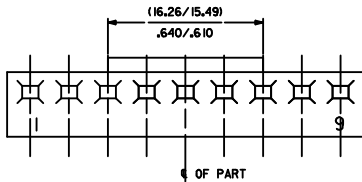

SELECTIVE RAMP OPTION CODE "C"

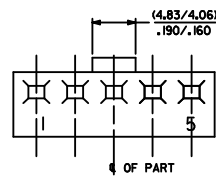

SELECTIVE RAMP OPTION CODE "B"

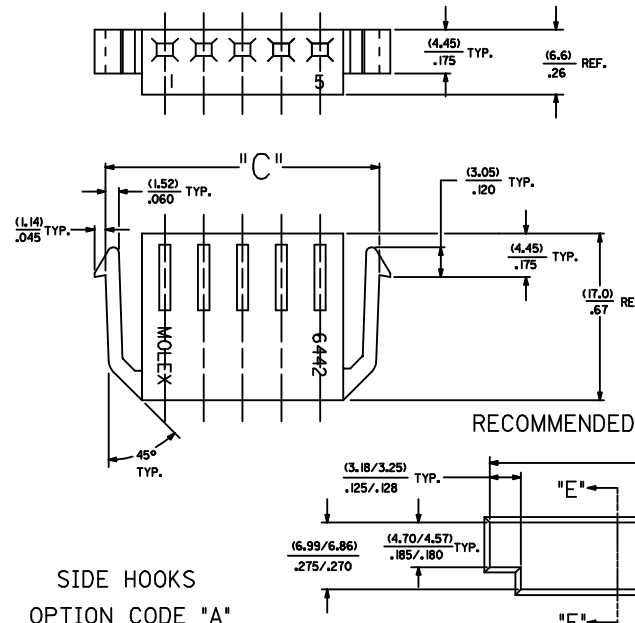

SIDE HOOKS OPTION CODE "A"

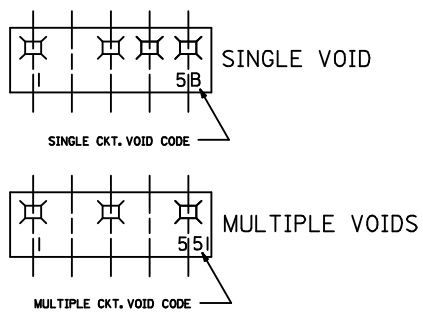

MOLDED VOIDS
SEE LEGEND ON SHT. 1
SEE CHART FOR VOID CKT. LOCATIONS

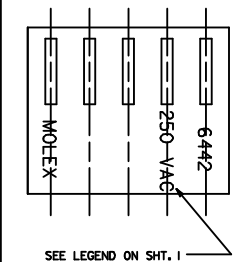

OPT. VOLTAGE RATING

NO. OF CKT'S.	DIM. "C"	DIM. "D"
2	(16.48/15.60) .643/.614	(15.47/15.34) .609/.604
3	(20.45/19.56) .805/.770	(19.43/18.30) .765/.760
5	(28.37/27.48) 1.117/1.082	(27.36/27.23) L077/1.072

SEE SHEET 1 IEC NO. UCP2009-3148 DRAWN BY DRANKIPPER CHKD BY SSOUSEK APPR. BY SMITH 2009/07/13 2009/08/05	QUALITY SYMBOLS	GENERAL TOLERANCES (UNLESS SPECIFIED)	DIMENSION STYLE	SCALE	DESIGN UNITS	THIRD ANGLE PROJECTION
	▽=0 ▽=0	mm INCH 4 PLACES ± .010 3 PLACES ± .014 2 PLACES ± 0.25 1 PLACE ± 0.36 ANGULAR ± 1/2°	MM/IN	---	INCH	DRAWN BY POLGAR CHECKED BY PATEL APPROVED BY LENZ DATE 1986/12/05 DATE 1986/12/05 DATE 1986/12/05
	DRAFT WHERE APPLICABLE MUST REMAIN WITHIN DIMENSIONS	SEE CHART	TITLE: KK (3.96)/156 TRIFURCON CRIMP TERMINAL HOUSING 6442 SERIES MATERIAL NO. MOLEX INCORPORATED DOCUMENT NO. SD-6442			
	SIZE D	THIS DRAWING CONTAINS INFORMATION THAT IS PROPRIETARY TO MOLEX INCORPORATED AND SHOULD NOT BE USED WITHOUT WRITTEN PERMISSION				

6442-N**			6442-RN**			6442-RN**			6442-RND**			6442-BN**			6442-CN**		
PART NO.	ENG. NO.	VOIDS	PART NO.	ENG. NO.	VOIDS	PART NO.	ENG. NO.	VOIDS	PART NO.	ENG. NO.	VOIDS	PART NO.	ENG. NO.	VOIDS	PART NO.	ENG. NO.	VOIDS
26-03-3011	6442-1-Z		26-03-4011	6442-R1-Z													
26-03-3021	6442-2-Z		26-03-4020	6442-R2-Z					26-03-7021	6442-R2D-Z							
26-03-3031	6442-3-Z		26-03-4030	6442-R3-Z					26-03-7031	6442-R3D-Z							
26-03-3041	6442-4-Z		26-03-4041	6442-R4-Z					26-03-7041	6442-R4D-Z							
26-03-3051	6442-5-Z		26-03-4050	6442-R5-Z						6442-R5D-Z							
26-03-3061	6442-6-Z		26-03-4061	6442-R6-Z						6442-R6D-Z							
26-03-3071	6442-7-Z		26-03-4070	6442-R7-Z					26-03-7071	6442-R7D-Z							
26-03-3081	6442-8-Z		26-03-4081	6442-R8-Z						6442-R8D-Z							
26-03-3091	6442-9-Z		26-03-4090	6442-R9-Z					26-03-7091	6442-R9D-Z							
26-03-3101	6442-10-Z		26-03-4101	6442-R10-Z						6442-R10D-Z							
26-03-3111	6442-11-Z		26-03-4111	6442-R11-Z						6442-R11D-Z							
26-03-3121	6442-12-Z		26-03-4121	6442-R12-Z					26-03-7121	6442-R12D-Z							
26-03-3131	6442-13-Z		26-03-4131	6442-R13-Z						6442-R13D-Z							
26-03-3141	6442-14-Z		26-03-4141	6442-R14-Z						6442-R14D-Z							
26-03-3151	6442-15-Z		26-03-4151	6442-R15-Z						6442-R15D-Z							
26-03-3161	6442-16-Z		26-03-4161	6442-R16-Z						6442-R16D-Z							
26-03-3171	6442-17-Z		26-03-4171	6442-R17-Z					26-03-7171	6442-R17D-Z							
26-03-3181	6442-18-Z		26-03-4181	6442-R18-Z						6442-R18D-Z							
26-03-3191	6442-19-Z		26-03-4191	6442-R19-Z						6442-R19D-Z							
26-03-3201	6442-20-Z		26-03-4201	6442-R20-Z						6442-R20D-Z							
26-03-3211	6442-21-Z		26-03-4211	6442-R21-Z						6442-R21D-Z							
26-03-3221	6442-22-Z		26-03-4221	6442-R22-Z						6442-R22D-Z							
26-03-3231	6442-23-Z		26-03-4231	6442-R23-Z						6442-R23D-Z							
26-03-3241	6442-24-Z		26-03-4241	6442-R24-Z						6442-R24D-Z							
	6442-15-B	2	26-03-4043	6442-R4-C	3				26-03-7042	6442-R4D-B	2						
	6442-9-B	2	26-03-4055	6442-R5-E	5				26-03-7072	6442-R7D-C	3						
	6442-12-F	6	26-03-4065	6442-R6-E	5				26-03-7092	6442-R9D-B	2						
	6442-7-51	1,7	26-03-4086	6442-R8-F	6				26-03-7093	6442-R9D-E	5						
	6442-9-51	1,9	26-03-4097	6442-R9-G	7				26-03-7122	6442-R12D-E	5						
	6442-9-52	2,9	26-03-4108	6442-R10-H	8				26-03-7172	6442-R17D-E	5						
	6442-8-B	2	26-03-4120	6442-R12-J	10												
	6442-8-F	6	26-03-4157	6442-R15-G	7												
	6442-10-D	4	26-03-4073	6442-R7-C	3												
	6442-5-B	2	26-03-4094	6442-R9-D	4												
	6442-10-B	2	26-03-4096	6442-R9-F	6												
	6442-5-C	3	26-03-4092	6442-R9-B	2												
	6442-13-B	2	26-03-4064	6442-R6-D	4												
	6442-11-E	5	26-03-4075	6442-R7-E	5												
			26-03-4095	6442-R9-E	5												
			26-03-4085	6442-R8-E	5												
			26-03-4072	6442-R7-B	2												
			26-03-4063	6442-R6-C	3												
			26-03-4062	6442-R6-B	2												
			26-03-4125	6442-R12-E	5												
			26-03-4123	6442-R12-C	3												
			26-03-4076	6442-R7-F	6												
			26-03-4129	6442-R12-1	9												
			26-03-4143	6442-R14-C	3												
			26-03-4093	6442-R9-C	3												
			26-03-4054	6442-R5-D	4												
			26-03-4052	6442-R5-B	2												
			26-03-4103	6442-R10-C	3												
			26-03-4042	6442-R4-B	2												
			26-03-4106	6442-R10-F	6												
				6442-R12-F	6												
			26-03-4112	6442-R11-B	2												
				6442-R13-B	2												
			26-03-4175	6442-R17-E	5												
			26-03-4102	6442-R10-B	2												
			26-03-4032	6442-R3-B	2												
			26-03-4082	6442-R8-B	2												
				6442-R7-51	1,7												
				6442-R9-51	1,9												
			26-03-4099	6442-R9-52	2,9												
			26-03-4149	6442-R14-M	13												
				6442-R4-A	1												
			26-03-4152	6442-R15-N	14												
				6442-R10-51	1,10												
			26-03-4083	6442-R-08-C	3												

UPDATE TITLE EC NO. UCF2009-3148 DRWNK/PPER CHKD/SSOUSEK APPR/FSM/TH 2009/07/13 2009/07/13 2009/08/05	QUALITY SYMBOLS =0 =0	GENERAL TOLERANCES (UNLESS SPECIFIED)		DIMENSION STYLE MM/IN		SCALE ---	DESIGN UNITS INCH	THIRD ANGLE PROJECTION	
		4 PLACES # --- # --- 3 PLACES # --- # --- 2 PLACES # --- # --- 1 PLACE # --- # ---	mm INCH	DRAWN BY POLGAR DATE 1986/12/02	CHECKED BY PATEL DATE 1986/12/02	APPROVED BY LENZ DATE 1986/12/02	MATERIAL NO. SEE CHART	DOCUMENT NO. SD-6442	SHEET NO. 3 OF 4
		DRAFT WHERE APPLICABLE MUST REMAIN WITHIN DIMENSIONS		KK (3.96)/156 TRIFURCON CRIMP TERMINAL HOUSING 6442 SERIES MOLEX INCORPORATED					