



Features:

- Universal AC input/ Full Range
- Energy Efficiency Level VI
- Output Protections: SCP/OCP
- No Load Power Consumption <0.1W
- 1 Year Warranty



Model	QFWB-18-5	QFWB-18-5.9	QFWB-18-7	QFWB-18-8	QFWB-18-9	QFWB-18-10	QFWB-18-12	QFWB-18-15	QFWB-18-18	QFWB-18-24	QFWB-18-36
Output Characteristics											
DC Output	5V	5.9V	7V	8V	9V	10V	12V	15V	18V	24V	36V
Rated Current	2.10A	2.10A	2.10A	2.10A	2.00A	1.80A	1.50A	1.20A	1.00A	0.75A	0.50A
Ripple and Noise	200mV Max										
Load Regulation (Typ.)	±5%										
Turn On Delay	3S Max										
Hold-up Time (Typ.)	10mS @ Rated Load 115VAC, 20mS @ Rated Load 230VAC										
Output Protection	Short Circuit, Over Current										
Ferrite Core	No										
Input Characteristics											
Voltage Range	100VAC~240VAC										
Frequency Range	50Hz-60Hz										
Efficiency	DoE Level VI, Energy Star										
AC Current (max)	0.6A										
Input Protection	Internal Primary Current Fuse, Inrush Limiting										
Leakage Current	0.25mA @ 264VAC/50Hz										
Environmental Characteristics											
Operating Temperature	0°C~40°C										
Operating Relative Humidity	10% RH to 80% RH										
Storage Temperature	-20°C~80°C, 5% RH to 95% RH										
Topology	Switching Flyback										
Dielectric Withstand	3000VAC/10mA Primary-Secondary										
EMI Conduction & Radiation	Compliance to EN55022 Class B, FCC Part 15 Class B										
Harmonic Current	Compliance to EN61000-3-2, 3										
EMS Immunity	Compliance to IEC61000-4-2, 3, 4, 5, 6, 8, 11										
Characteristics											
MTBF	50,000Hrs (25°C, Telecordia SR-332)										
Dimension (LxWxH)	71.3x43.3x28.8mm										
Weight	105g										

PART NUMBER SYSTEM

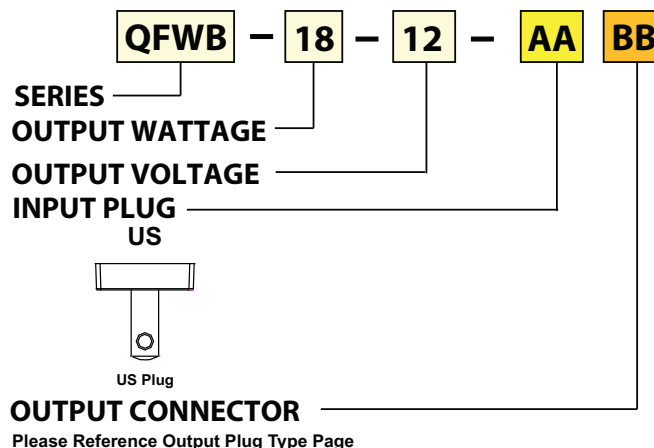

MECHANICAL SPECIFICATIONS

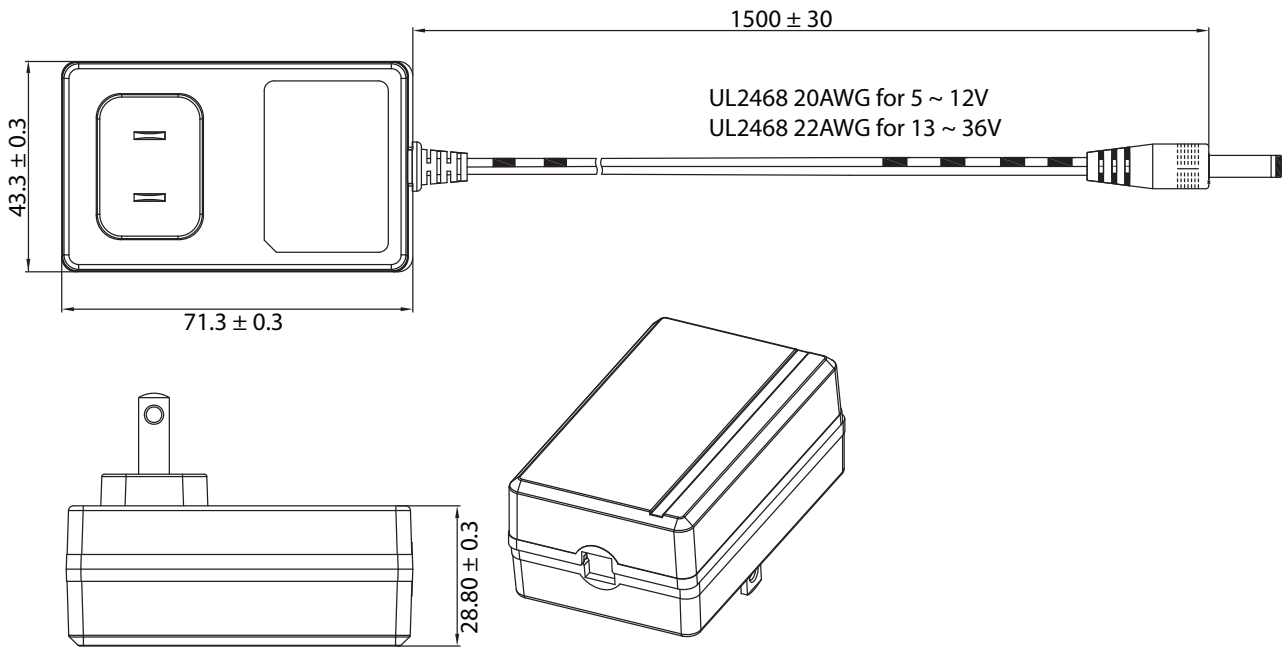

DERATING CURVE

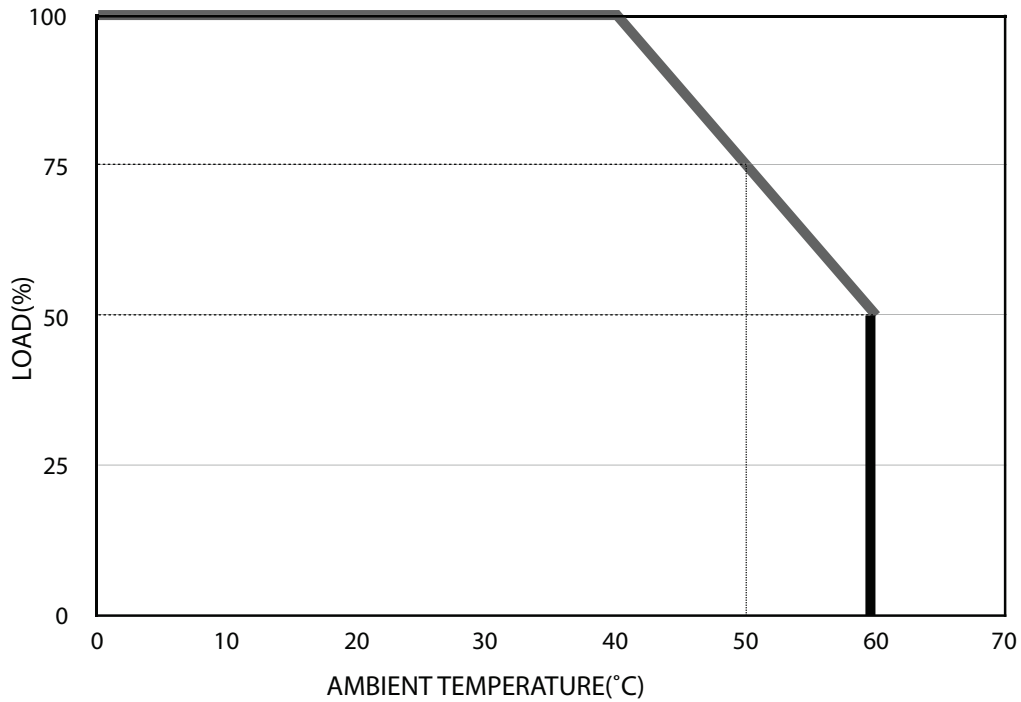

UNIT: mm