

3193 POWER HiTESTER

Power measuring instruments



Printer is optional unit

DC/0.5Hz to 1MHz broad-band POWER HiTESTER measures up to 6 systems simultaneously.

Wide Spectrum Power Meter for Comprehensive Device Assessment

3194 MOTOR / HARMONIC HiTESTER



3194 MOTOR / HARMONIC HiTESTER provides analysis of high-order harmonics up to the 3000th order. Additionally, with the optional **9603-01 EXTERNAL SIGNAL INPUT UNIT** installed, the HiTESTER can directly measure torque and rotation speed, an essential feature for evaluating the performance of inverter motors. This makes it easy to construct measurement systems.

The **3193 POWER HiTESTER** is a multi-function power meter for use with single phase power lines to 3-phase, 4-wire circuits. Accommodating up to 6 units, it is not only capable of measuring up to 6 single phase systems, but can simultaneously measure the input and output of a 3-phase inverter and provide effective power measurements. Additionally, it supports harmonic analysis and flicker measurement (optional), features which are essential for overall device assessment. Standard features include a GP-IB/RS-232C interface and 3.5-inch floppy disk drive, making it easy to feed data to a personal computer for processing and analysis. This unit is ideal for those requiring greater efficiency in electrical device assessment.



ISO 9001
JMI-0216



ISO 14001
JQA-E-90091



<http://www.hioki.co.jp/>

HIOKI company overview, new products, environmental considerations and other information are available on our website.

Broad coverage, high accuracy, and well-developed interface

Complete with functions that answer all your power measurement needs.



Features

■ Wide range of measurement functions

Capable of measuring voltage, current, active /reactive /apparent power, power factor, phase, frequency, and current, and of integrating power according to polarity, the 3193 (or 3194) also provides wave peak and efficiency measurements that are essential to device assessment.

■ Can Measure Motor Output

With the optional 9603 EXTERNAL SIGNAL INPUT UNIT, the HiTESTER can take analog input in from torque and revolution measurements and use that information to calculate motor output.

■ Measurement for Minute Stand-by Power also Available (by special-order product)

The 9600 and 9601 input units have 10-times improved current sensitivity, and currents starting from the 20.000mA range can be measured. (Please ask for further information.)

■ High Visibility Color LCD

Featuring a wide viewing angle, the color LCD displays a variety of items simultaneously, making it ideal for quickly grasping power usage on the system being measured. Expanded display is possible for any four selected items.

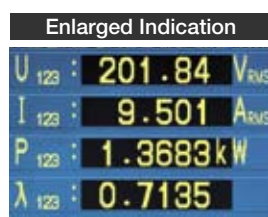

■ Harmonic and Flicker Analysis

Harmonic and flicker analysis are possible when using the optional 9605 HARMONIC / FLICKER MEASUREMENTS UNIT (3193 only).

■ High Basic Accuracy of $\pm 0.2\%$

Measurements of even greater precision can be obtained using the optional 9600 to 9602 input unit, which provides a basic accuracy of $\pm 0.1\%$ rdg, $\pm 0.1\%$ f.s. (With the 9602, the accuracy of the clamp-on sensor is a factor affecting total accuracy during power measurement.)

■ A Variety of Interfaces for Differing Needs

★ Connecting to a PC

The 3.5 inch floppy disk drive and RS-232C / GP-IB interface, provided as standard features, make it possible to connect the power meter directly to a PC, allowing efficient measurement, management and analysis of data.



★ Connecting to a Recorder

With 8 selectable D/A outputs and voltage, current and power analog/monitor output (current and voltage only) as standard features, the HiTESTER allows recording of changes and transient fluctuations in waveforms using a recording unit.



★ Connecting to a Printer

Data can be output to the optional 9604 PRINTER UNIT.



Print type : Thermal line dot printing
Paper width : 72mm
Main functions : printing of items measured, hard copy output of displayed screens, printout of meter settings, printout of various times (such as interval time, timer time, and realtime control time).
Printouts are performed either automatically, upon input of an external control signal, or synchronized with an integrator.

Other Analysis Functions

Integration According to Polarity

Positive, negative, and total current and power can be integrated simultaneously for all channels. This makes it possible to grasp the income and outflow of power at a glance.

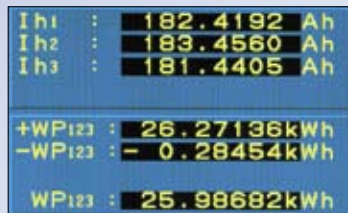

Provides Analog and D/A output.

Analog (voltage, current, and effective power) and D/A outputs (any selected eight items) are output as a 5V range full scale value. (Except for the 1000V range), 100ms response time can be obtained by using the FAST setting.

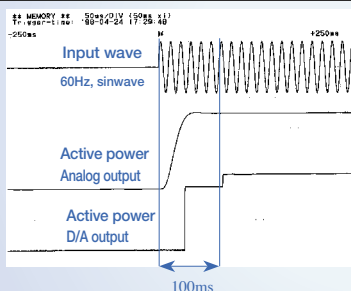

● 3 Types of Averaging Function

Select from time average, moving average and exponential average.

● 3ch Frequency Measurement Function

With the frequency ranges, LPF and HPF can be used in combination, allowing measurement of fundamental waveforms and carrier waveforms of inverters.

● Efficiency Calculation Function

Three efficiency calculations can be obtained simultaneously from measured voltage values.

Peak Measurements Function

Voltage and current wave peaks can be measured. The Peak Hold function can be used to find peak values and effective maximums for motor rush current waves.

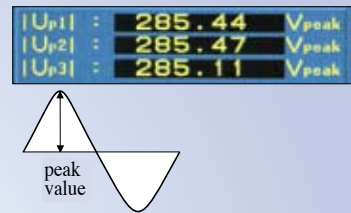

Wave Monitor Output

With the voltage and current ranges, waveforms are output as 1V full scale values, allowing waveforms to be monitored using devices such as recorders or synchroscopes.

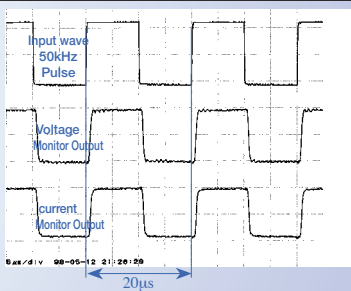

● 3 Types of Built-in Low Pass Filters

Selectable cutoff frequencies (500/5k/300kHz) allow extraction of the frequency component of fundamental inverter waveforms and provide data compatibility with previous instruments.

● Choose from Three Types of Calculation Algorithms

Three selectable algorithms are provided for calculating apparent power and reactive power, providing compatibility with previous devices

Choose from a variety of input units according to application

Three types of input units are available, including the 9602 clamp input meter, which can be used with current levels exceeding 50A under live circuit conditions, as well as the 9600 and 9601 which accept direct input of up to 1000V/50A.

● 9600 · · · DC/0.5Hz to 1MHz wide band

● 9601 · · · 5Hz to 100kHz, for AC only

● 9602 · · · DC/0.5Hz to 200kHz clamp input

A variety of clamp on sensors are available, including models 9270 to 9272 for AC only, and models 9277 to 9279 for AC/DC.

1ch	2ch	3ch	4ch	5ch	6ch
1 ϕ 2W	1 ϕ 2W	1 ϕ 2W	1 ϕ 2W	1 ϕ 2W	1 ϕ 2W
1 ϕ 3W / 3 ϕ 3W	1 ϕ 2W	1 ϕ 2W	1 ϕ 2W	1 ϕ 2W	1 ϕ 2W
1 ϕ 3W / 3 ϕ 3W	1 ϕ 3W / 3 ϕ 3W	1 ϕ 2W	1 ϕ 2W	1 ϕ 2W	1 ϕ 2W
1 ϕ 3W / 3 ϕ 3W	1 ϕ 3W / 3 ϕ 3W	1 ϕ 3W / 3 ϕ 3W	1 ϕ 3W / 3 ϕ 3W	1 ϕ 3W / 3 ϕ 3W	1 ϕ 3W / 3 ϕ 3W
3V3A (3 ϕ 3W) / 3 ϕ 4W	1 ϕ 2W	1 ϕ 2W	1 ϕ 2W	1 ϕ 2W	1 ϕ 2W
3V3A (3 ϕ 3W) / 3 ϕ 4W	1 ϕ 3W / 3 ϕ 3W	1 ϕ 2W	1 ϕ 2W	1 ϕ 2W	1 ϕ 2W
3V3A (3 ϕ 3W) / 3 ϕ 4W	3V3A (3 ϕ 3W) / 3 ϕ 4W	3V3A (3 ϕ 3W) / 3 ϕ 4W	3V3A (3 ϕ 3W) / 3 ϕ 4W	3V3A (3 ϕ 3W) / 3 ϕ 4W	3V3A (3 ϕ 3W) / 3 ϕ 4W

Simultaneous Measurement of Multiple Systems

Since all units are mutually isolated, the primary and secondary sides of devices or disparate power lines can be measured simultaneously. Simultaneous measurement of single phase 6 wire or 3 phase 2 wire systems which previously required multiple units, can now be handled with one. What's more, measurements of all devices can be taken at the same instant, providing a powerful tool for integrated, all-round device assessment.

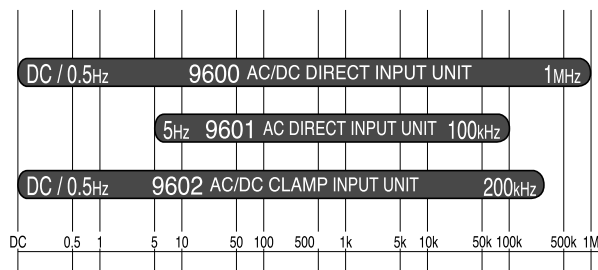

9600 Frequency characteristics (at 15W[15V×1A] range, response slow)

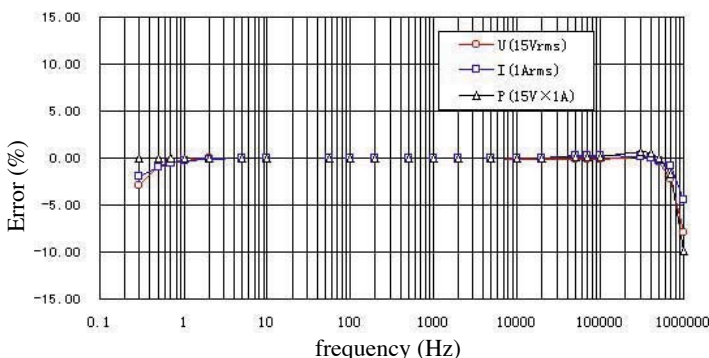

Effect of common mode voltage

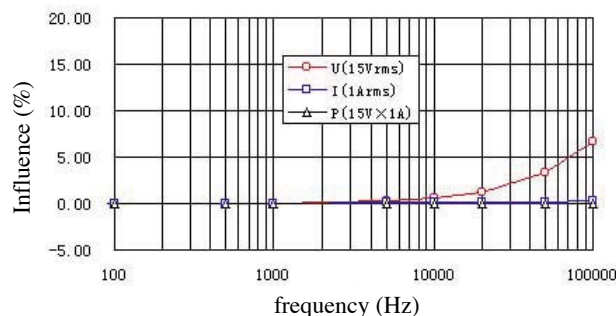

Can measure all items at same point in time

The Power Analysis Station

Applications of 3193

Example of Application With Power Converter

Measure mixed AC and DC components with a single unit.

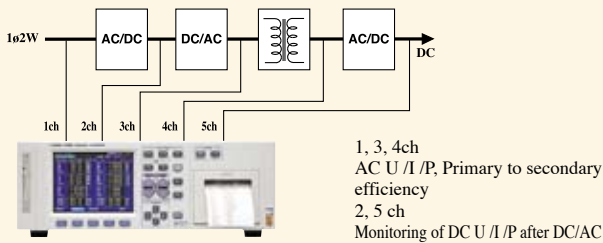

Example of Assessment Trial of EV (Electric Vehicle)

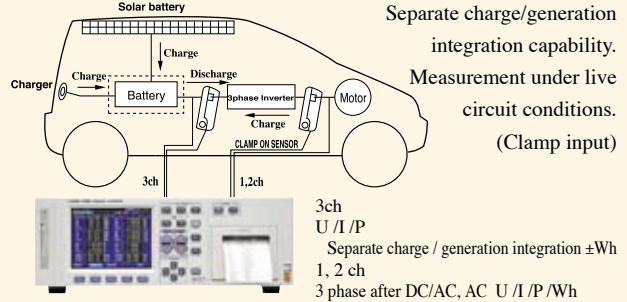

3194 Performs Comprehensive Evaluation of 3-phase Inverter Motors

Capable of measuring carrier frequencies on the secondary side of inverters. Also allows analysis to be synchronized with motor rotation.

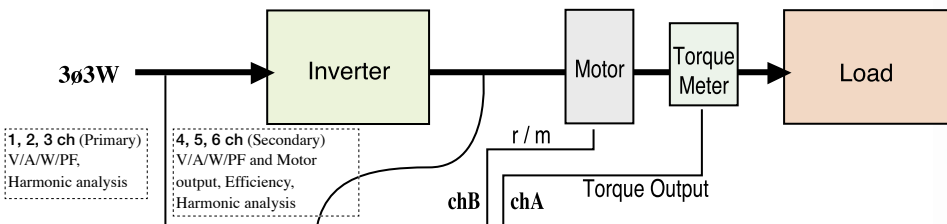

9603-01 Specifications

Torque, rotation speed, and motor power can be measured by inputting analog torque and r/m signals to the 9603-01 EXTERNAL INPUT UNIT. Further, an input terminal is provided for use with a strain gauge-type torque sensor.

9603-01 EXTERNAL INPUT UNIT	
Input channels	: 2 channels
Ch A	: Strain gauge sensor or DC voltage input (BNC)
Ch B	: Pulse or DC voltage input (BNC)
Strain gauge input specifications (dedicated connector)	
Applicable converter	: Strain gauge type converter (bridge resistance 350Ω - 1.5kΩ)
Measurement range	: 1 mV/V / 1.5 mV/V / 2 mV/V
Measurement accuracy	: ±0.1%rdg, ±0.065%f.s.
Connector	: PRC03-23A10-7F (manufactured by Tajimi)
DC voltage input specifications (ch A / ch B common BNC connector)	
Input resistance	: 200kΩ ±5% (differential)
Measurement range	: ±1.0000 / ±5.0000 / ±10.000V
Measurement accuracy	: ±0.1%rdg, ±0.1%f.s. (23°C ±5°C, not higher than 80%rh)
Pulse input specifications (ch B, BNC connector)	
Frequency measurement	: 1Hz to 100 kHz
Common specifications	
Analog output	: ±5V f.s. (Output accuracy : Measurement accuracy ±0.2%f.s.)

3194 Specifications (Harmonic Waveform Analysis Function)

- Measurement lines** : Single-phase 2- and 3- wire, three-phase 3- and 4-wire
- No. of channels** : Up to 3 channels from channels 1 to 6
- Measurement range** : Fundamental frequency: 10 Hz to 4.5 kHz

Harmonic Waveform Analysis Functions

- Measurement method** : PLL or external clock
- A/D resolution** : 12 bits
- Windowing type** : Rectangular tiling (with gap between windows)
- Crest factor** : Up to 2.5 (voltage, current)
- PLL source** : U, I or external synchronization
- Ext. synchronization signal** : Input to a rear panel control terminal on the 3194 main unit
Input level: 1V to 10 Vrms, Division function: 1/1 to 1/255
- Measurement items** : RMS voltage, RMS current, effective power value, frequency, ±U peak, ±I peak
- Harmonic wave measurement items** : Harmonic level, percentage and phase angle of harmonic wave, Total harmonic distortion (THD-F, THD-R)
- Screen displays** : List, graph, vector and waveform displays
- Wiring conversion Sort function** : Δ-Y voltage conversion, Y-Δ voltage conversion
- Sort function** : Sorts according to decreasing order of analysis, displays up to 50th order
- Averaging function** : Index average with time constant of 1.5 sec
- Frequency ranges** :

	Fundamental Frequency	Sampling speed (Hz)	Window Width	Analysis Order
PLL Synchronization Ranges	10 - 17.5 Hz	f × 8192	1 waveform	3000 (10kHz or less)
	17.5 - 35 Hz	f × 8192	1 waveform	3000 (10kHz or less)
	35 - 70 Hz	f × 8192	1 waveform	3000 (100kHz or less)
	70 - 140 Hz	f × 4096	2 waveforms	1500 (100kHz or less)
	140 - 280 Hz	f × 2048	4 waveforms	800 (100kHz or less)
	280 - 560 Hz	f × 1024	8 waveforms	400 (100kHz or less)
	560 - 1120 Hz	f × 512	16 waveforms	200 (100kHz or less)
Fixed clock	1120 - 2240 Hz	f × 256	32 waveforms	100 (100kHz or less)
	2240 - 4500 Hz	f × 128	64 waveforms	50 (100kHz or less)
Fixed clock	---	50 × 8192 Fixed	2 waveforms	3000 (100kHz or less)

Note 1: Analysis order accuracy is restricted to the frequency in brackets.

Note 2: With PLL synchronization in the range of 10 to 35 Hz, an anti-aliasing filter of about 15 kHz is used, and with PLL synchronization in the range of 35 Hz to 4.5kHz, an anti-aliasing filter of about 120 kHz is used.

Applications of 3193

Support up to Harmonic / Flicker analysis when using the optional 9605 HARMONIC / FLICKER MEASUREMENTS UNIT .

Graph Display of Harmonics

Voltage, current and power can be analyzed and displayed by bargraphs of harmonic amplitude, content and phase angle. Voltage, current and power can be displayed simultaneously for a single channel, or a single parameter can be displayed simultaneously for each of three channels.

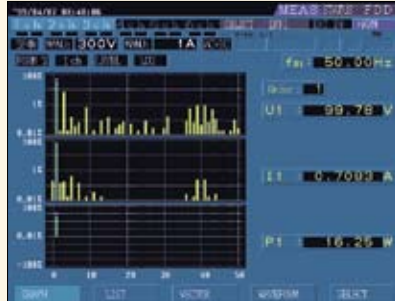

Vector Display of Harmonics

The harmonic vector display shows the voltage, current and phase angle for each harmonic, making clear the voltage-current phase relationship.



Flicker Measurement Display

Displays data during measurement in real-time. Display can also be switched to D measurement and "Pst" value.



List Display of Harmonics

The harmonic list display shows the amplitude, proportion, phase angle and distortion for each harmonic of voltage, current and power. Displaying only proportion, or two parameters simultaneously, such as amplitude and phase angle, is selectable.



Waveform Display

The waveform display shows one cycle of the voltage and current waveforms. RMS and peak values can be displayed along with voltage and current waveforms, or voltage and current waveforms for up to three channels can be displayed at the same time.

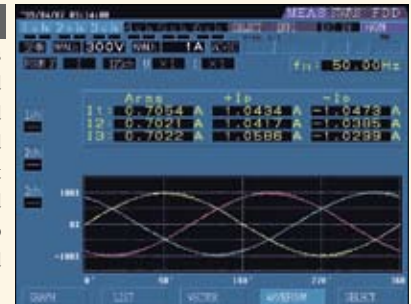

Monitor Display

The relative "d" voltage change $\Delta V/V$ and the instantaneous flicker value "S(t)" can be displayed in a time series, so past variations are clearly displayed.



9605 Specifications (optional)

Installation : Installs in the 3193 main unit
Measurement lines : Single-phase 2- and 3-wire, three-phase 4-wire
No. of channels : Up to 3 channels within channels 1 to 6, depending on 3193 wiring mode
Output functions : Floppy disk, RS-232C, GP-IB, printer

● Harmonic Waveform Analysis Functions (IEC61000-3-2*)

Measurement range : Fundamental frequency: 1 to 440 Hz
 PLL system (5 to 440 Hz), external clock system (1 to 5 Hz)
Orders analyzed : Up to 50th harmonic (with 1 to 250 Hz fundamental)
Window width : 16 cycles (for 40 to 70 Hz fundamental)
Windowing type : Rectangular tiling (no gap between or overlap of windows)
Amount of data analyzed : 512 points (for 40 to 70 Hz fundamental)
Crest factor : Up to 4 (current), and up to 3 (voltage)
Measurement items : Harmonic level, percentage and phase angle of each order of harmonic wave for each of voltage, current and power. Total up to 50th harmonic (of 40 to 70 Hz fundamental) for voltage, current and power. Total harmonic distortion for voltage and current (THD-F and THD-R)
 Measurement of voltage, current, active power, peak voltage and peak current values of the fundamental

*1. The 9605 does not support limit values, so pass/fail decisions based on limit values, classification of special waveforms (A to D) and 2.5-minute measurement function for measuring transient harmonic currents are not supported.

Update rate : Every 1 window (except during communications with other devices)
Screen displays : List, graph, vector and waveform
Accuracy* : Harmonic levels; at 45 to 66 Hz
 Voltage/current: $\pm 0.5\%$ rdg. $\pm 0.05\%$ f.s.
 Active power: $\pm 1.0\%$ rdg. $\pm 0.1\%$ f.s.
 For 45 to 66-Hz fundamental, effective input is 0.1 to 110% of range, total error of harmonic current when PLL is locked is 5% of the limit value or within 0.2% of the rated current of the device under test (no limitation with 9602).

● Flicker Measurement Function (IEC61000-3-3**)

Measurement range : Fundamental frequency; 45 to 66 Hz, PLL synchronization system
Analysis items : dc (relative constant voltage change), d max (max. relative constant voltage change), d(t)200ms (relative voltage change per time), P0.1/ P1s/ P3s/ P10s and 30s (cumulative probability), Pst (short-term flicker value), Plt (long-term flicker value)
Screen displays : Measured value, CPF, Pst list, Monitor
Accuracy* : Within $\pm 5\%$ rdg. of limit on the limit curve line (Pst = 1) specified for voltage fluctuation in IEC60868-0 (d measurement is the same)
 RMS voltage $\pm 0.5\%$ rdg. $\pm 0.05\%$ f.s. (45Hz~66Hz)

**2. Decision function not included.

**3. The reading accuracy of the input unit must combined with the analysis accuracy shown above. When used with a clamp sensor, accuracy and frequency characteristics of the clamp must be added to the analysis accuracy above.

Optional Input Unit Specifications

The 9600 and 9601 are also the products for stand-by power measurement with 10-times improved sensitivity for current ranges. Please ask for detailed specs.

	9600 AC/DC DIRECT INPUT UNIT			9602 AC/DC CLAMP INPUT UNIT		
	Voltage	Current	Active power	Voltage	Current	Active power
Measurement range	6.0000/15.000/30.000/ 60.000/150.00/300.00/ 600.00V/1.0000 kV	200.00/500.00mA/ 1.0000/2.0000/5.0000/ 10.000/20.000/50.000 A	Depends on combination of voltage and current ranges	6.0000/15.000/30.000/ 60.000/150.00/300.00/ 600.00V	500.00mA to 500.00A (Depends on clamp-on sensor)	Depends on combination of voltage and current ranges
Max. operating input (60Hz)	1000Vrms/1500 V peak	65Arms/100 A peak		650Vrms/850Vpeak	(Depends on clamp-on sensor)	
Crest factor	Lower of either (measured range X 6) / measured value or maximum permissible rated peak / measured value			Lower of either (measured range X 6) / measured value or maximum permissible rated peak/measured value		
Input resistance	2MΩ±5%	1mΩ max.		2MΩ±5%	200kΩ±5%	
Accuracy	(Accuracy assured at 23°C±5°C (73°F ±9°F) at 80% R.H., power factor = 1, sine wave input, in-phase voltage 0, after DMAG)					
DC	±0.1%rdg.±0.2%f.s.	←	←	±0.1%rdg.±0.2%f.s.	←	←
0.5 to 1Hz	±0.5%rdg.±0.5%f.s.	←	←	±0.5%rdg.±0.5%f.s.	←	←
1 to 10Hz	±0.2%rdg.±0.2%f.s.	←	←	±0.2%rdg.±0.2%f.s.	←	←
10 to 45Hz	±0.1%rdg.±0.2%f.s.	←	←	±0.1%rdg.±0.2%f.s.	←	←
45 to 66Hz	±0.1%rdg.±0.1%f.s.	←	←	±0.1%rdg.±0.1%f.s.	←	←
66Hz to 10kHz	±0.1%rdg.±0.2%f.s.	←	←	±0.1%rdg.±0.2%f.s.	←	←
10 k to 50kHz	±0.3%rdg.±0.3%f.s.	←	←	±0.5%rdg.±0.5%f.s.	←	←
		Less than 5 A Greater than 5 A	Less than 5 A Greater than 5 A			
50 k to 100kHz	±0.5%rdg.±0.5%f.s.	±0.5%rdg. ±0.5%f.s.	±2.5%f.s.	±0.5%rdg. ±0.5%f.s.	±5.0%f.s.	±0.3%rdg.±0.5%f.s.
100k to 300kHz	±0.5%rdg.±0.5%f.s.	±0.5%rdg. ±0.5%f.s.	±5%f.s.	±1.0%rdg. ±1.5%f.s.	±10.0%f.s.	±15%f.s. (up to 200kHz)
300k to 400kHz	±1.5%rdg.±0.5%f.s.	±1.0%rdg. ±0.5%f.s.		±1.0%rdg. ±2.5%f.s.		
400k to 500kHz	±2.0%rdg.±1.0%f.s.	±2.0%rdg. ±1.0%f.s.		±2.0%rdg. ±2.5%f.s.		
500k to 700kHz	±10.0%f.s.	±10.0%f.s.		±15.0%f.s.		
700k to 1 MHz	±15.0%f.s.	±15.0%f.s.		±30.0%f.s.		

■ Compatible Clamp (Optional)

9270-9271 9272 9279 9277/9278 9709

With the 9602, the accuracy of the clamp-on sensor is a factor affecting total accuracy during current measurement, as are phase and frequency characteristics. See page 7 for details on the clamp-on sensor specifications.

	9601 AC DIRECT INPUT UNIT		
	Voltage	Current	Active power
Measurement range	60.000/150.00/300.00/6 00.00V/1.0000 kV	200.00/500.00mA/ 1.0000/2.0000/5.0000/ 10.000/20.000/50.000 A	Depends on combination of voltage and current ranges
Max. operating input (60Hz)	1000Vrms/1500 V peak	65Arms/100 A peak	
Crest factor	Lower of either (measured range X 6) / measured value or maximum permissible rated peak / measured value		
Input resistance	2MΩ±5%	1mΩ max.	
Accuracy (Accuracy assured at 23°C±5°C (73°F ±9°F) at 80% R.H., power factor = 1, sine wave input, in-phase voltage 0)			
5 to 10Hz	±2.5%f.s.	←	←
10 to 20Hz	±1.0%f.s.	←	←
20 to 45Hz	±0.1%rdg.±0.2%f.s.	←	←
45 to 66Hz	±0.1%rdg.±0.1%f.s.	←	←
66Hz to 5kHz	±0.1%rdg.±0.2%f.s.	←	←
5k to 10kHz	±0.2%rdg.±0.4%f.s.	←	←
10k to 20kHz	±1.0%f.s.	←	←
20k to 50kHz	±2.5%f.s.	←	←
50k to 100kHz	±10.0%f.s.	←	←

Assured Accuracy Range for Input Frequency of the 9600

9601 and 9602 each have assured ranges for input frequency.

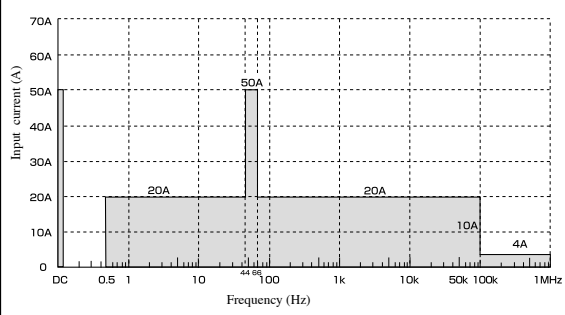
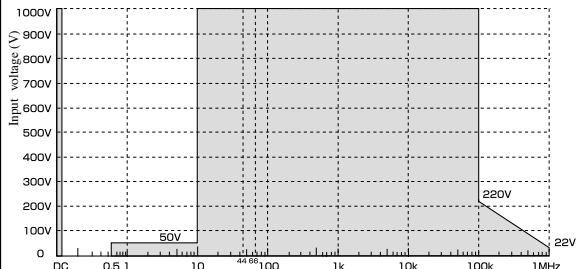

Note 1: Assured accuracy ranges for different response settings are as follows: FAST (0.1 sec) to DC and greater than 50 Hz, MID (0.8 sec) to DC and greater than 10 Hz, SLOW (5.0 sec) to DC or greater than 0.5 Hz

Note 2: Assured accuracy ranges for combined mode measurement are 10 Hz or greater for the AC mode, and DC only for the AC+DC mode or DC mode.

Calculation algorithm (Indicated only for single phase, 2 wire and 3 phase, 3 wire (3V3A). Two additional calculation algorithms can be selected for apparent/reactive power)

	Voltage	Current	Active power	Apparent power	Reactive power	Power factor	Phase
1φ2W	U_1	I_1	P_1	$S_1 = U_1 \times I_1$	$Q_1 = S_1 - \sqrt{(U_1 I_1)^2 - P_1^2}$	$\lambda_1 = S_1 P_1 / S_1^2$	$\phi_1 = S_1 \cos^{-1} \lambda_1 $
SUM	3φ3W (3V3A) $U_{1,2,3} = \frac{U_1 + U_2 + U_3}{3}$	$I_{1,2,3} = \frac{I_1 + I_2 + I_3}{3}$	$P_{1,2,3} = P_1 + P_2$	$S_{1,2,3} = \frac{\sqrt{3}}{3} (U_1 I_1 + U_2 I_2 + U_3 I_3)$	$Q_{1,2,3} = \frac{\sqrt{3}}{3} \sqrt{(U_1 I_1)^2 - P_1^2 + (U_2 I_2)^2 - P_2^2}$	$\lambda_{1,2,3} = S U \left \frac{P_{1,2,3}}{S_{1,2,3}} \right $	$\phi_{1,2,3} = S U \cos^{-1} \lambda_{1,2,3} $

Note 1: The above calculation algorithm is for a single phase, 2 wire input to ch 1, and 3 phase, 3 wire input to ch 1/2/3 (3 voltage, 3 current).

Note 2: The "s" before each power factor or phase operation indicates the lead or lag of current phase in relation to voltage. The "-" sign means current phase leads voltage and when there is no symbol, it lags. "su" is "-" when the sum of reactive power is negative and "+" (but unsigned) when it is positive.

Basic specifications

Measurement line : Single phase 2 wire, single phase 3 wire, 3 phase 3 wire (3V3A is possible), 3 phase 4 wire

Measurement item : When using 9600, 9601, 9602 (optional)
Voltage, current, voltage/current peak, effective/reactive/apparent power, power factor, phase, frequency, current/power integration, load rate, efficiency.
When using the 9603 (optional)
Voltage, torque, r/min, frequency, motor output.
When using the 9605 (optional)
Harmonic, waveform, voltage fluctuation / flicker measurement function.

Display indication range : At the lowest range in the DC mode of Models 9600 & 9602: 0.2% to 130%
At the lowest range in the AC+DC mode of Models 9600 & 9602: 0.5% to 130%
At the 200mA range of Model 9601: 0.5% to 130%
At 0.1% to 130% of all other ranges.
All range is zero suppressed at less than lower % value.
Valid input range for voltage, current, and power is 0.5% to 110%

Display : 6.4 inch TFT color LCD (640 × 480 dot)
Display resolution : 99999 count (except with integration), 9999999 count (with integration)
Rectification method : Switchable between RMS (true root mean square value) and MEAN (average rectified RMS indication). When combined mode DC is selected, its not possible to switch between them.

Display update rate : 8 times/sec.
Combined mode : DC, AC + DC, AC (AC only when used in combination with 9601 or 9602 + AC clamp-on sensor)

Analog response time : FAST (0.1 sec.), MID (0.8 sec.), SLOW (5.0 sec.)
(Time required for stabilization to within ±1% when input is changed from 0% to 90%, or 100% to 10% of range.)

Low pass filter : OFF / 500Hz / 5kHz / 300kHz (-3dB) For 9601, 5k / 300kHz not available.

Polarity detection regulation filter : OFF / 200Hz (-3dB)

Analog output : Voltage / current / active power
DC ±5V f.s (1000V range is DC ±3.333 V f.s.)

Monitor output : Voltage / current: 1Vrms f.s. (1000V range is 0.6667 Vrms f.s.)

[Voltage/ Current/ Active power measurement]

Measurement range : See Page 5 specifications for individual input units

[Integration measurement]

Number of measurements : 64 times/sec

Measurement range : 0 to ±9999999 TAh / TWh (integration time up to 10,000 hours)

[Power factor/ Phase angle measurement]

Measurement range : -1.0000 (lead) to 0.0000 to 1.0000 (lag)
-180°(lead) to 0.00° to 180.00°(lag)

[Frequency measurement]

Number of channels : Max. 3ch (selection of voltage or current for arbitrary channel)

Effective input range : 0.5 Hz to 2 MHz

Measurement range : Auto / 50Hz / 500Hz / 50 kHz / 2 MHz

[Wave peak measurement]

Measurement items : Select either voltage or current for each unit (Shows absolute value of max.)

Effective Input Range : Effective value of sine wave is within effective input permissible in the range

Measurement accuracy (23°C±5°C (73°F±9°F), Less than 80% rh, warm up time greater than 1 hour, sine wave input, power factor = 1, in-phase voltage = 0)

V, A, W : Per accuracy table on page 5
Apparent / reactive power : ±1 dgt. with respect to calculation from measured value (U, I, P) sum value is max. ±3dgt.
Integration : ±1dgt with respect to values calculated from measurements (I, P)
Power factor : Max. ±3dgt with respect to values calculated from measurements (U, I, P)
Phase angle : Max. ±3dgt with respect to values calculated from measurements (U, I, P)
Frequency : ±0.1% rdg. ±1 dgt. (0°C to 40°C(32°F to 104°F), for sine wave input between 10% to 130% of U/I range)
Wave peak : ±1% (at 0.5Hz to 1kHz), ±2% (at 1kHz to 10kHz), ±10% (at 10kHz to 100kHz)

General Specifications

Location for use : Indoors, altitude to 2000 m
Ambient use humidity : Power meter, 0°C to 40°C (32°F to 104°F), rh below 80% (no condensation)
When using FDD / printer, 5°C to 40°C (41°F to 104°F), rh below 80%
Ambient storage humidity : -10°C to 50°C (14°F to 122°F), rh below 80% and no condensation
Insulation resistance : More than 100MΩ from DC500V
Greater than 50MΩ (at DC500V between U/I input terminal and unit case, between U/I input terminal and power supply plug (for the 9600/9601), between U input terminal and clamp input terminal, between U input terminal and unit case, and between U input terminal and power supply plug (for 9602)
Withstand voltage : AC5.55kV between U/I terminal and unit case, between U/I terminal and power supply plug (for 9600 and 9601), between U terminal and clamp input terminal, between U terminal and unit case, between U input terminal and power supply plug (for 9602)

[Motor output (Pm) measured] 9603 (optional) external input unit required

Measurement method : Digital calculation from measured voltage or pulse signal
Effective when 9603 ch A is torque (any of N/m, mN/m, kN/m, kgf/m, kgf/cm), and ch B is r/m
Display indication range : 0.1% to 130% of 9603 voltage range (polarity not indicated)
Calculation algorithm : Set to required format

[Efficiency measurement]

Calculable factors : Maximum of 3 formats
Calculated items : P for each input unit, Pm when combined with 9603 (Items measured with 9605 not allowed)

[D/A output]

Number of channels : 8ch (12 bit D/A converter polarity + 11bit)
Output impedance : 100Ω±5%
Output items : Outputs 8 arbitrarily selected items
Output voltage : DC±5V/f.s.
Output update rate : 16 times/sec

[FDD]

Compatible media : 3.5-inch, 2HD (1.2MB/1.44MB)
Format : MS-DOS
Functions : Function for saving and loading settings, and saving measured values. Function for outputting measured values. Floppy disk formatting function, file renaming and deleting

[Interface]

GP-IB : Conforms to IEEE-488.1 1987, with reference to IEEE-488.2 1987
RS-232C : Start-stop synchronous, with baud rate of 2400 or 9600 bits/sec

[External Control]

Functions : Integration start / stop control, Integration data reset, External A/D (For display update when power meter display is in hold mode), Manual print control, FD save control
Control signal level : From 0 / 5V logic signal or short/open contact signal

[Other functions]

Scaling : PT/CT ratio Set range 0.0001 to 10000
Averaging : Time average (set interval time, timer time, and average of realtime control time)
Moving average (number of samples: 8/16/32/64)
Exponential average (attenuation factor: 8/16/32/64)
Multilingual display : Japanese/English screen display switching
Set time (all types) : Interval control time (10 sec to 100 hours) in 10 sec increments
(When used in combination with FDD or printer, auto select increments)
Timer control time (1 min to 10000 hours) in 1 minute increments
Realtime control time, 1 minute increments

[Harmonic / Flicker measurement] 9605 (optional) required

Measurement item : See Page 4 specifications for 9605

Motor output : ±1dgt for calculations of each measured value
Efficiency : Max. ±7 dgt with respect to values calculated from measurements of items substituted into algorithm
Thermal coefficient : Within ±0.03% f.s/ °C
Effect of in-phase voltage : Within ±0.05% f.s (1000 Vrms, 50/60Hz, between shorted voltage input terminals and case)
Effect of power factor : ±0.15% f.s (power factor = 0)
Actual time : ±25ppm ±1dgt. (0 to 40°C (73°F to 104°F))
D/A output : Display accuracy - ±0.2% f.s
Analog output : Display accuracy - ±0.2% f.s
Monitor output : Display accuracy - ±0.2% f.s (less than 100kHz)
Display accuracy - ±3dB (100k to 1MHz)

Certifications : Safety
EN61010-1: 2001
EMC
EN61326: 1997+A1: 1998+A2: 2001 class A
EN61000-3-2: 2000
EN61000-3-3: 1995+A1: 2001
Power supply : AC100V/120V/200V/230V (switched automatically), 50/60Hz
Maximum rated power : 150VA max.
Dimensions, mass : Approx 430 W × 150 H × 370 D mm, Approx 13 kg
(Approx 16.93"(W) 5.91"(H)14.57"(D), Approx 458.6 oz.)
(in configuration including 9600 5 6ch, 9603, 9604)
(Not including projections such as terminals, feet, and handles)
Accessories : Power cord 1, ground adapter (3P to 2P) 1, connector 1

■ CLAMP-ON SENSOR(Optional) Specifications

To use the Clamp-On sensor, be sure to order the factory option **9602** AC/DC clamp input unit.

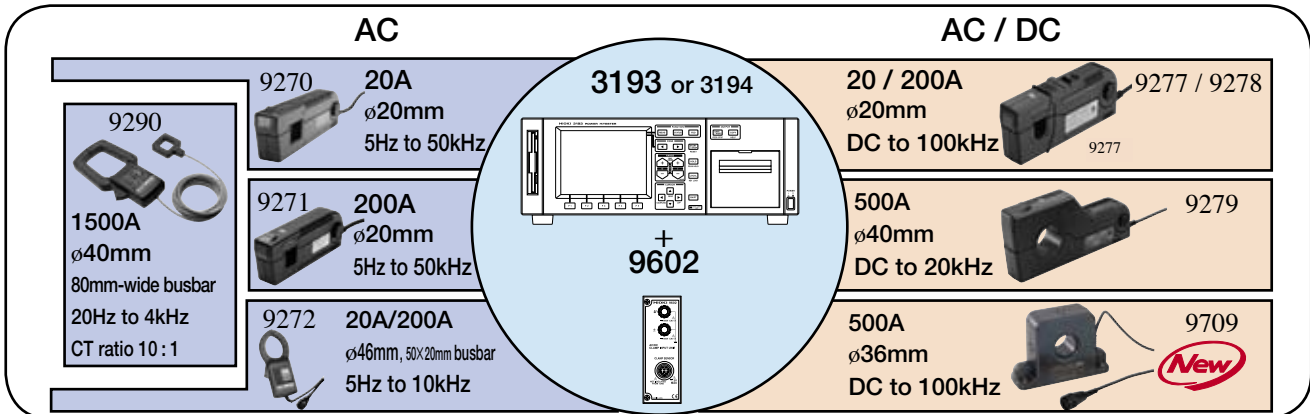

Model	9270	9271	9272	9277	9278	9279	9709
Rated current	20A AC	200A AC	20/200A AC	20A AC/DC	200A AC/DC	500A AC/DC	500A AC/DC
Accuracy 23°C±3°C, 45 to 66Hz (73°F±5.4°F)	±0.5%rdg. ±0.05%f.s.(vibration amplitude) ±0.2° max.(phase)			After degaussing and warming up for at least 30 minutes: ±0.5%rdg. ±0.05%f.s. (vibration amplitude) ±0.2° max.(phase, DC not specified)			Warming up for at least 10 minutes: ±0.05%rdg. ±0.01%f.s.(vibration amplitude) ±0.2° max. (phase, DC not specified)
Frequency characteristics (vibration amplitude, phase) (deviation from the basic accuracy)	10Hz to 30kHz, ±1.0%, ±0.5° max. 5Hz to 50kHz, ±2.5%, ±1.0° max.		10Hz to 1kHz, ±1.0%, ±0.5° max. 5Hz to 10kHz, ±2.5%, ±2.0° max.	DC to 1kHz, ±1.0%, ±0.5° max. 1k to 50kHz, ±2.5%, ±2.5° max. 50k to 100kHz, ±5.0%, ±5.0° max.		DC to 1kHz, ±1.0%, ±0.5° max. 1k to 10kHz, ±2.5%, ±2.5° max. 10k to 20kHz, ±5.0%, ±5.0° max.	DC to 45Hz, ±0.2%, ±0.3° max. To 10kHz, ±2.0%, ±2.0° max. To 100kHz, ±30%, ±30° max. <small>*For further details, please refer to the individual product catalog for the instrument.</small>

Ordering information

3193 POWER HiTESTER (main unit only)

3194 MOTOR / HARMONIC HiTESTER (main unit only)

Measurements cannot be taken with a **3193 POWER HiTESTER** and **3194 MOTOR / HARMONIC HiTESTER** unit only.

A factory option input unit must be purchased.

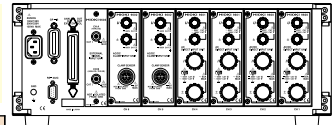

	1ch	2ch	3ch	4ch	5ch	6ch
Pattern A	1 ϕ 2W ()	1 ϕ 2W ()	1 ϕ 2W ()	1 ϕ 2W ()	1 ϕ 2W ()	1 ϕ 2W ()
Pattern B	1 ϕ 3W / 3 ϕ 3W (×2)	1 ϕ 2W ()	1 ϕ 2W ()	1 ϕ 2W ()	1 ϕ 2W ()	1 ϕ 2W ()
Pattern C	1 ϕ 3W / 3 ϕ 3W (×2)	1 ϕ 3W / 3 ϕ 3W (×2)	1 ϕ 2W ()	1 ϕ 2W ()	1 ϕ 2W ()	1 ϕ 2W ()
Pattern D	1 ϕ 3W / 3 ϕ 3W (×2)	1 ϕ 3W / 3 ϕ 3W (×2)	1 ϕ 3W / 3 ϕ 3W (×2)	1 ϕ 3W / 3 ϕ 3W (×2)	1 ϕ 3W / 3 ϕ 3W (×2)	1 ϕ 2W ()
Pattern E	3V3A (3 ϕ 3W) / 3 ϕ 4W (×3)	1 ϕ 2W ()	1 ϕ 2W ()	1 ϕ 2W ()	1 ϕ 2W ()	1 ϕ 2W ()
Pattern F	3V3A (3 ϕ 3W) / 3 ϕ 4W (×3)	1 ϕ 3W / 3 ϕ 3W (×2)	1 ϕ 2W ()	1 ϕ 2W ()	1 ϕ 2W ()	1 ϕ 2W ()
Pattern G	3V3A (3 ϕ 3W) / 3 ϕ 4W (×3)	3V3A (3 ϕ 3W) / 3 ϕ 4W (×3)	3V3A (3 ϕ 3W) / 3 ϕ 4W (×3)	3V3A (3 ϕ 3W) / 3 ϕ 4W (×3)	3V3A (3 ϕ 3W) / 3 ϕ 4W (×3)	3V3A (3 ϕ 3W) / 3 ϕ 4W (×3)

Notes on input unit selection

- Use the same input unit for a particular measurement line.
- Install units in succession starting from channel 1.
- For the **9603** or **9603-01**, only one unit can be installed.
- When the **9602** is selected, use the optional clamp-on sensor.

Options that can be installed at the factory

(specify at time of order)

9600	AC/DC DIRECT INPUT UNIT
9601	AC DIRECT INPUT UNIT
9602	AC/DC CLAMP INPUT UNIT
9603	EXTERNAL SIGNAL INPUT UNIT (3193 only)
9603-01	EXTERNAL SIGNAL INPUT UNIT (3194 only)
9604	PRINTER UNIT
9605	HARMONIC / FLICKER MEASUREMENTS UNIT (3193 only)

*The voltage cable is not supplied. Contact your dealer when it is necessary to use the clip type leads.

Options

* 9270	CLAMP ON SENSOR (20A AC)
* 9271	CLAMP ON SENSOR (200A AC)
* 9272	CLAMP ON SENSOR (20/200A AC)
9277	UNIVERSAL CLAMP ON CT (20A AC/DC)
9278	UNIVERSAL CLAMP ON CT (200A AC/DC)
* 9279	UNIVERSAL CLAMP ON CT (500A AC/DC)
9709	AC/DC CURRENT SENSOR (500A AC/DC)
* 9290	CLAMP ON ADAPTER (1500A AC, ratio10:1)
9232	RECORDING PAPER (10 m, 10 roll, For 9604)

*No CE marking

HIOKI

HIOKI E. E. CORPORATION

HEAD OFFICE :

81 Koizumi, Ueda, Nagano, 386-1192, Japan
TEL +81-268-28-0562 / FAX +81-268-28-0568
E-mail: os-com@hioki.co.jp

HIOKI USA CORPORATION :

6 Corporate Drive, Cranbury, NJ 08512 USA
TEL +1-609-409-9109 / FAX +1-609-409-9108
E-mail: hioki@hiokiusa.com

Shanghai Representative Office :

1704 Shanghai Times Square Office
93 Huaihai Zhong Road
Shanghai, 200021, P.R.China
TEL +86-21-6391-0090/0092
FAX +86-21-6391-0360
E-mail: info@hioki.cn

DISTRIBUTED BY