

RB30 Radial Bobbin Inductors

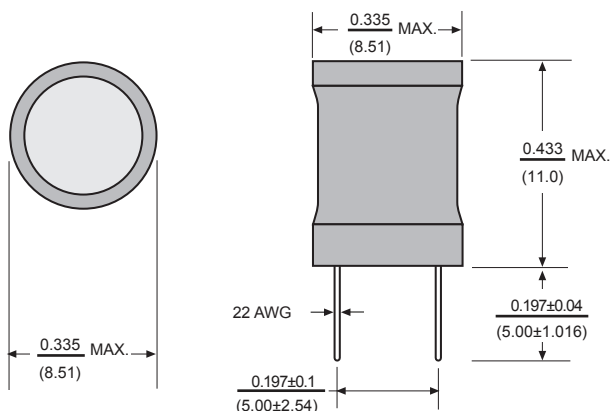

Dimensions: $\frac{\text{Inches}}{\text{(mm)}}$



Features

- Radial leaded pre-tinned leads.
- Protected with UL approved polyolefin shrink tubing.
- Non-standard values and tolerances available.

Electrical

Inductance Range: 1.0 μ h to 100mh

Tolerance: 10% for all values. Tighter tolerances available.

Test Procedures: L&Q Measured with HP4342A Q-Meter at specified Frequency.
DCR Measured on CH-301, SRF Measured on HP-4191A, HP4291B.

Current Rating: Based on Inductance Drop of < 10% at rated current

Operating Temp: -55°C to + 125°C

Physical

Packaging: 100 pieces per bag.

Marking: EIA Inductance Code

Allied Part Number	Inductance (μ h)	Tolerance (%)	Q Min.	Test Freq. (MHz)	SRF Min. (MHz)	DCR Max. (Ω)	Rated Current (A)
RB30-1R0K-RC	1.0	10	20	7.960	150	.013	10.0
RB30-1R5K-RC	1.5	10	20	7.960	130	.016	8.50
RB30-2R2K-RC	2.2	10	20	7.960	100	.021	6.50
RB30-3R3K-RC	3.3	10	20	7.960	79	.025	5.50
RB30-4R7K-RC	4.7	10	20	7.960	51	.030	4.30
RB30-6R8K-RC	6.8	10	20	2.520	29	.035	3.70
RB30-100K-RC	10	10	50	2.520	14	.045	3.00
RB30-120K-RC	12	10	50	2.520	13	.050	2.70
RB30-150K-RC	15	10	40	2.520	12	.056	2.30
RB30-180K-RC	18	10	40	2.520	11	.061	2.20
RB30-220K-RC	22	10	40	2.520	9.2	.070	2.00
RB30-270K-RC	27	10	30	2.520	8.5	.080	1.70
RB30-330K-RC	33	10	30	2.520	7.8	.090	1.60
RB30-390K-RC	39	10	30	2.520	6.9	.100	1.50
RB30-470K-RC	47	10	30	2.520	6.5	.160	1.40
RB30-560K-RC	56	10	30	2.520	5.4	.180	1.30
RB30-680K-RC	68	10	30	2.520	4.9	.210	1.20
RB30-820K-RC	82	10	30	2.520	4.1	.023	1.10
RB30-101K-RC	100	10	20	0.796	3.7	.280	0.91
RB30-121K-RC	120	10	20	0.796	3.4	.320	0.84
RB30-151K-RC	150	10	20	0.796	3.2	.370	0.75
RB30-181K-RC	180	10	20	0.796	2.8	.580	0.69
RB30-221K-RC	220	10	20	0.796	2.7	.650	0.64
RB30-271K-RC	270	10	20	0.796	2.4	.750	0.57
RB30-331K-RC	330	10	20	0.796	2.3	.850	0.54
RB30-391K-RC	390	10	20	0.796	2.1	1.00	0.48
RB30-471K-RC	470	10	20	0.796	1.9	1.10	0.46
RB30-561K-RC	560	10	20	0.796	1.8	1.40	0.41
RB30-681K-RC	680	10	20	0.796	1.6	1.60	0.38
RB30-821K-RC	820	10	20	0.796	1.5	1.80	0.35
RB30-102K-RC	1000	10	50	0.796	1.3	2.90	0.29
RB30-122K-RC	1200	10	50	0.252	1.1	4.00	0.13
RB30-152K-RC	1500	10	20	0.252	1.0	6.10	0.08
RB30-182K-RC	1800	10	20	0.252	1.0	6.40	0.08
RB30-222K-RC	2200	10	20	0.252	0.9	6.80	0.08
RB30-272K-RC	2700	10	20	0.252	0.9	7.70	0.08
RB30-332K-RC	3300	10	20	0.252	0.7	9.00	0.08
RB30-392K-RC	3900	10	20	0.252	0.6	14.0	0.08
RB30-472K-RC	4700	10	20	0.252	0.5	16.0	0.05
RB30-562K-RC	5600	10	20	0.252	0.4	18.0	0.05
RB30-682K-RC	6800	10	20	0.252	0.4	19.0	0.05
RB30-822K-RC	8200	10	20	0.252	0.3	21.0	0.05
RB30-103K-RC	10000	10	40	0.079	0.3	25.0	0.05
RB30-123K-RC	12000	10	40	0.079	0.3	33.0	0.04
RB30-153K-RC	15000	10	40	0.079	0.2	37.0	0.04
RB30-183K-RC	18000	10	30	0.079	0.2	40.0	0.04
RB30-223K-RC	22000	10	30	0.079	0.1	56.0	0.03
RB30-273K-RC	27000	10	30	0.079	0.1	62.0	0.03
RB30-333K-RC	33000	10	30	0.079	0.1	70.0	0.03
RB30-393K-RC	39000	10	30	0.079	0.1	80.0	0.03
RB30-473K-RC	47000	10	20	0.079	0.1	99.0	0.03
RB30-563K-RC	56000	10	20	0.079	0.1	135	0.02
RB30-683K-RC	68000	10	20	0.079	0.1	150	0.02
RB30-823K-RC	82000	10	20	0.079	0.1	212	0.02
RB30-104K-RC	100000	10	20	0.025	0.1	235	0.02

All specifications subject to change without notice.