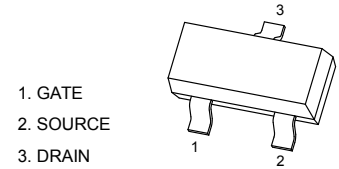

**SOT-23 Plastic-Encapsulate MOSFETS**
**20V P-Channel MOSFET**

$V_{(BR)DSS}$	$R_{DS(on)Typ}$	$I_D Max$
-20V	37mΩ@ -4.5V	-4.8A
	43mΩ@ -3.3V	

**SOT-23**

**FEATURE**

- Excellent  $R_{DS(ON)}$ , low gate charge, low gate voltages

**APPLICATION**

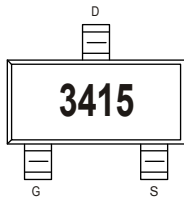
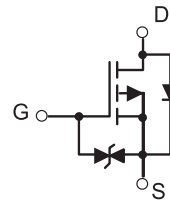
- Load switch and in PWM applications

**MARKING**

**Equivalent circuit**

**PACKAGE SPECIFICATIONS**

Package	Reel Size	Reel DIA. (mm)	Q'TY/Reel (pcs)	Box Size (mm)	QTY/Box (pcs)	Carton Size (mm)	Q'TY/Carton (pcs)
SOT-23	7'	178	3000	203×203×195	45000	438×438×220	180000

**Maximum Ratings and Thermal Characteristics (TA = 25°C unless otherwise noted)**

Parameter	Symbol	Limit	Unit	
Drain-Source Voltage	$V_{(BR)DSS}$	-20	V	
Gate-Source Voltage	$V_{GS}$	±8		
Continuous Drain Current	$I_D$	$T_A = 25^\circ C$	-4.8	A
		$T_A = 70^\circ C$	-3.6	
Pulsed Drain Current <sup>1)</sup>	$I_{DM}$	-30	A	
Maximum Power Dissipation <sup>2)</sup>	$P_D$	$T_A = 25^\circ C$	1.5	W
		$T_A = 70^\circ C$	1.0	
Operating Junction and Storage Temperature Range	$T_J, T_{stg}$	-50 to 150	°C	
Junction-to-Ambient Thermal Resistance (PCB mounted) <sup>2)</sup>	$R_{thJA}$	80	°C/W	

**Notes**

- <sup>1)</sup> Pulse width limited by maximum junction temperature.  
<sup>2)</sup> Surface Mounted on FR4 Board,  $t \leq 5$  sec.

The above data are for reference only.



**MOSFET ELECTRICAL CHARACTERISTICS**

$T_a=25\text{ }^\circ\text{C}$  unless otherwise specified

Parameter	Symbol	Test Condition	Min	Typ	Max	Units
<b>Static Parameters</b>						
Drain-source breakdown voltage	$V_{(BR)DSS}$	$V_{GS} = 0V, I_D = -250\mu A$	-20			V
Gate threshold voltage	$V_{GS(th)}$	$V_{DS} = V_{GS}, I_D = -250\mu A$	-0.4	-0.7	-1.2	
Zero gate voltage drain current	$I_{DSS}$	$V_{DS} = 20V, V_{GS} = 0V (T_A=25\text{ }^\circ\text{C})$			-1	$\mu A$
		$V_{DS} = 16V, V_{GS} = 0V (T_A=125\text{ }^\circ\text{C})$			-100	
Gate-body leakage current	$I_{GSS}$	$V_{DS} = 0V, V_{GS} = \pm 8V$			$\pm 10$	
Drain-source on-state resistance(note1)	$R_{DS(on)}$	$V_{GS} = -4.5V, I_D = -4A$		37	45	m $\Omega$
		$V_{GS} = -3.3V, I_D = -3A$		43	55	
		$V_{GS} = -2.5V, I_D = -2A$		52	65	
Forward transconductance(note2)	$g_{FS}$	$V_{DS} = -5V, I_D = -4A$	8			S
<b>Dynamic Parameters (note3)</b>						
Input capacitance	$C_{iss}$	$V_{DS} = -10V, V_{GS} = 0V, f = 1MHz$		675		pF
Output capacitance	$C_{oss}$			120		
Reverse transfer capacitance	$C_{rss}$			85		
Gate resistance	$R_g$	$V_{DS} = 0V, V_{GS} = 0V, f = 1MHz$		6.5		$\Omega$
<b>Switching Parameters</b>						
Total gate charge	$Q_g$	$V_{DS} = -10V, V_{GS} = -4.5V, I_D = -4A$		14.2		nC
Gate-Source charge	$Q_{gs}$			3.2		
Gate-drain charge	$Q_{gd}$			5.8		
Turn-on delay time (note3)	$t_{d(on)}$	$V_{DS} = -10V, V_{GS} = -4.5V$ $R_{GEN} = 3\Omega, R_L = 2.5\Omega,$		15		ns
Turn-on rise time(note3)	$t_r$			11		
Turn-off delay time(note3)	$t_{d(off)}$			22		
Turn-off fall time(note3)	$t_f$			35		
<b>Drain-source body diode characteristics</b>						
Continuous source-drain diode current	$I_S$	$T_C = 25\text{ }^\circ\text{C}$			-2.0	A
Body diode voltage (note 2)	$V_{SD}$	$I_S = -2A, V_{GS} = 0V$		-0.83	-1.2	V

**Notes:**

- 1) PRRepetitive rating, pulse width limited by junction temperature.
- 2) Pulse test: pulse width  $\leq 300\mu s$ , duty cycle  $\leq 2\%$ .
- 3) These parameters have no way to verify.

Typical Characteristics

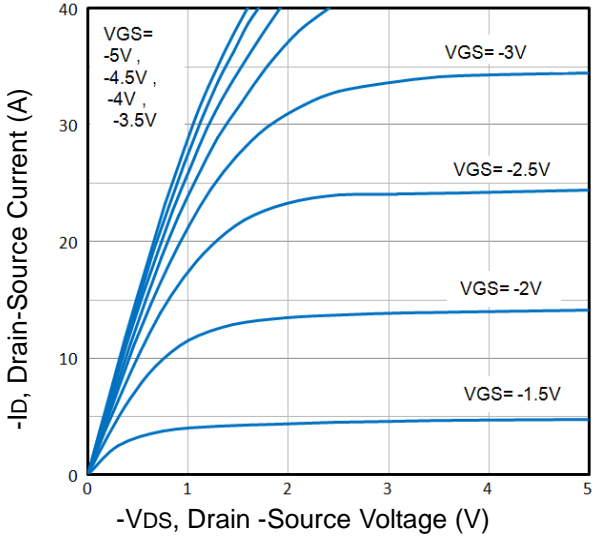

Fig1. Typical Output Characteristics

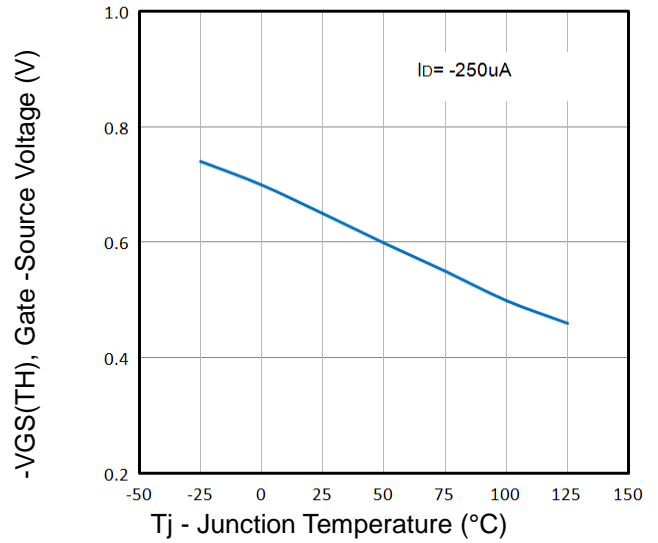

Fig2. Normalized Threshold Voltage Vs. Temperature

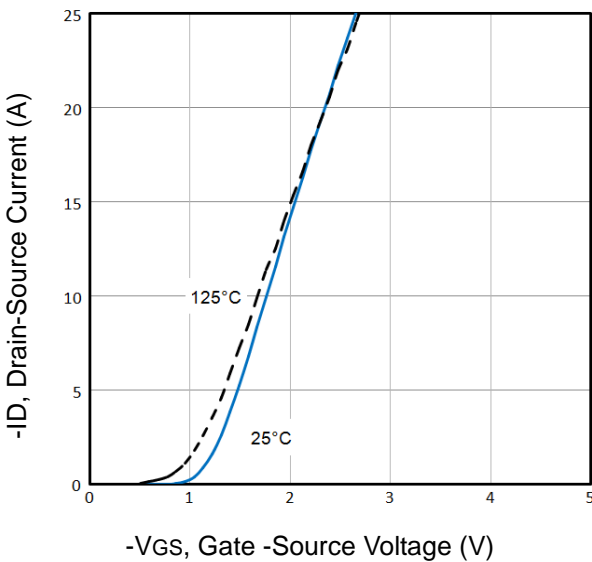

Fig3. Typical Transfer Characteristics

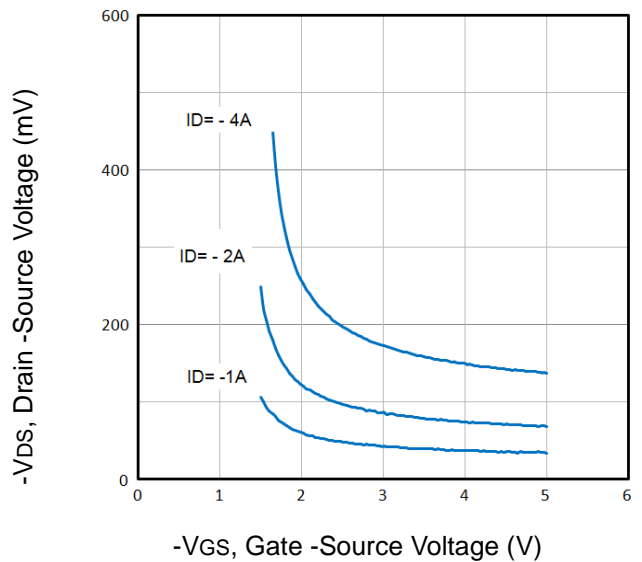

Fig4. Drain-Source Voltage vs Gate-Source Voltage

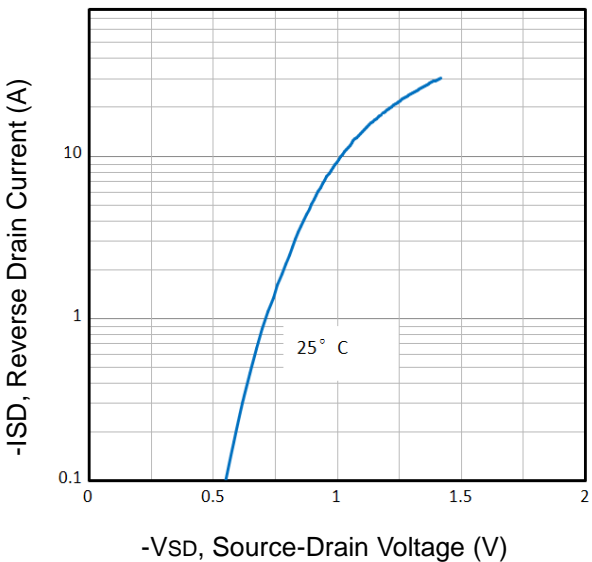

Fig5. Typical Source-Drain Diode Forward Voltage

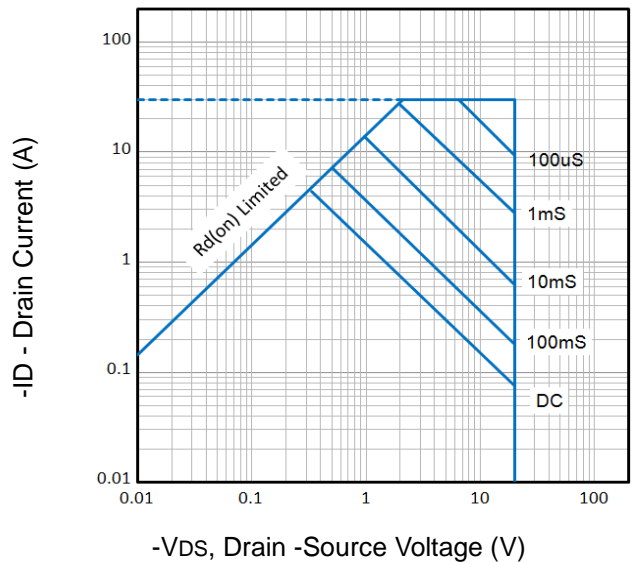

Fig6. Maximum Safe Operating Area

Typical Characteristics

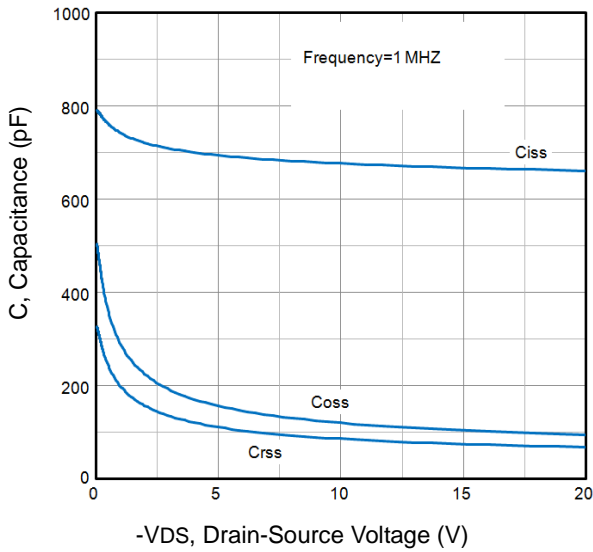

Fig7. Typical Capacitance Vs. Drain-Source Voltage

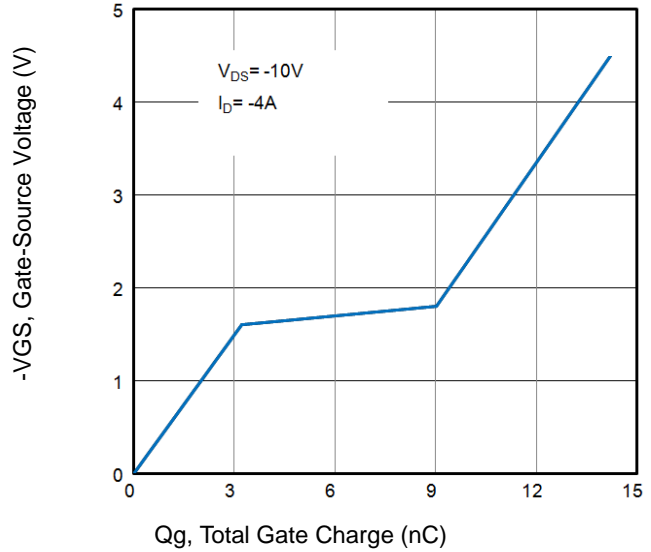

Fig8. Typical Gate Charge Vs. Gate-Source Voltage

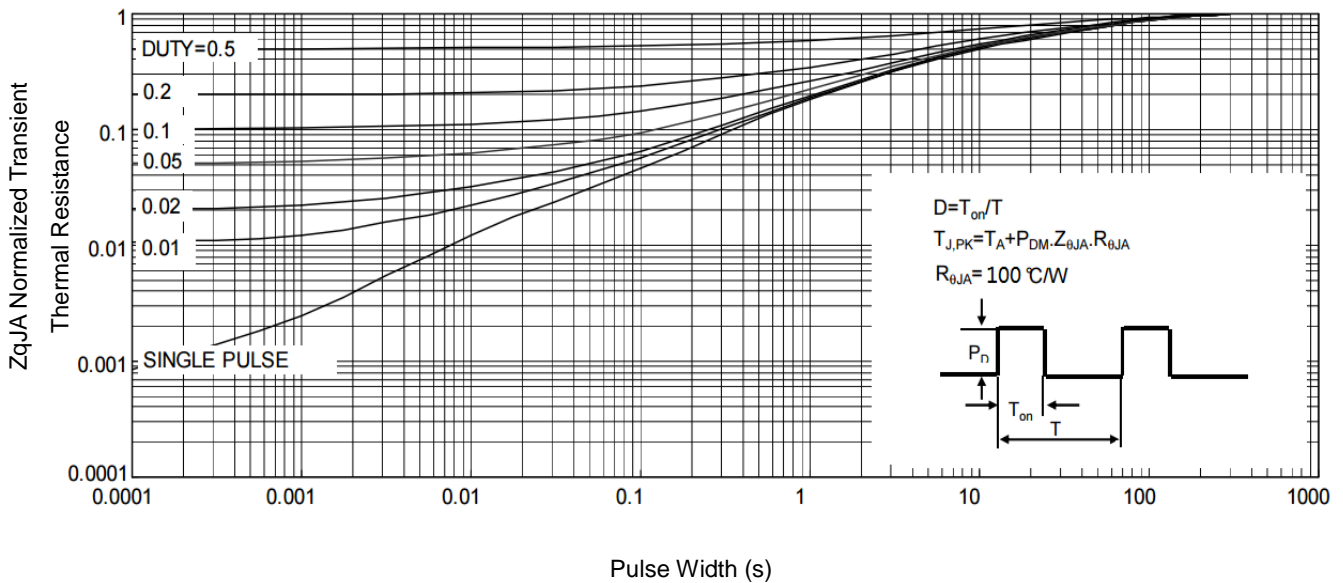

Fig9. Normalized Maximum Transient Thermal Impedance

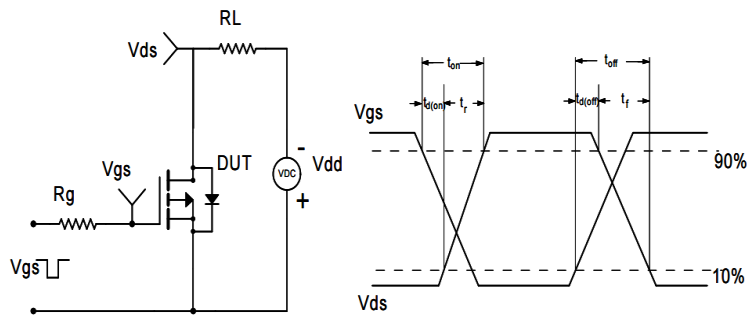
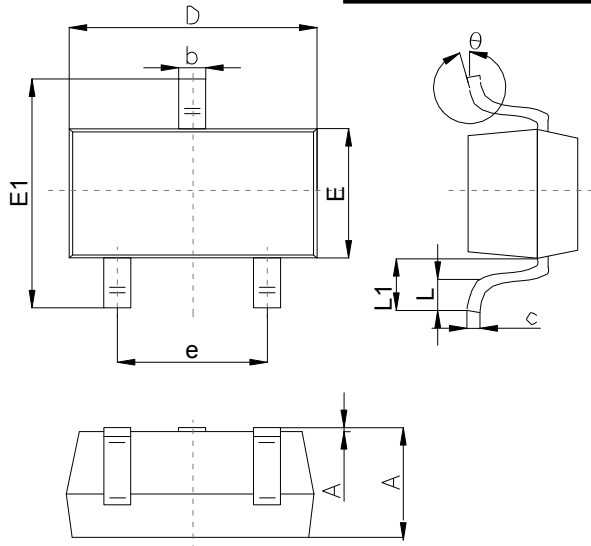

Fig10. Switching Time Test Circuit and waveforms

**Outlitne Drawing**

**SOT-23 Package Outline Dimensions**



Symbol	Dimensions In Millimeters		
	Min	Typ	Max
A	0.90		1.40
A1	0.00		0.10
b	0.30		0.50
c	0.08		0.20
D	2.80	2.90	3.10
E	1.20		1.60
E1	2.25		2.80
e	1.80	1.90	2.00
L	0.10		0.50
L1	0.4		0.55
θ	0°		10°

**Suggested Pad Layout**

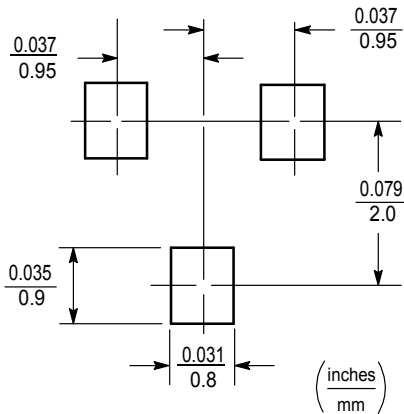

Note:

1. Controlling dimension:in/millimeters.
- 2.General tolerance: ±0.05mm.
- 3.The pad layout is for reference purposes only.