

### Features:

- Halogens free
- Current transfer ratio  
(CTR: 50~600% at  $I_F = 5\text{mA}$ ,  $V_{CE} = 5\text{V}$ )  
(CTR: 40~320% at  $I_F = 10\text{mA}$ ,  $V_{CE} = 5\text{V}$ )
- High isolation voltage between input and output ( $V_{iso} = 3750\text{ V rms}$ )
- Compact 4 Pin SSOP with a 2.0 mm profile
- Pb free and RoHS compliant.
- UL approved (No. 214129)
- VDE approval (132249)
- SEMKO approved
- NEMKO approved
- DEMKO approved
- FIMKO approved
- CSA approved

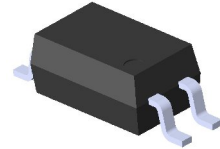

### Schematic

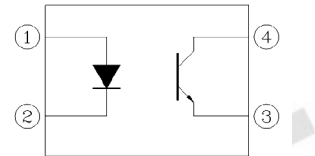

### Pin Configuration

1. Anode
2. Cathode
3. Emitter
4. Collector

### Description

The EL3H7-G series devices consist of an infrared emitting diode, optically coupled to a phototransistor detector encapsulated with green compound.

They are packaged in a 4-pin small outline SMD package.

### Applications

- DC-DC Converters
- Programmable controllers
- Telecommunication equipments
- Signal transmission between circuits of different potentials and impedances

**Absolute Maximum Ratings (T<sub>a</sub>=25°C)**

Parameter		Symbol	Rating	Unit
Input	Forward current	I <sub>F</sub>	50	mA
	Peak forward current (1us, pulse)	I <sub>FP</sub>	1	A
	Reverse voltage	V <sub>R</sub>	6	V
	Power dissipation Derating factor (above T <sub>a</sub> = 90°C)	P <sub>D</sub>	70	mW
	2.0		mW/°C	
Output	Power dissipation Derating factor (above T <sub>a</sub> = 70°C)	P <sub>C</sub>	150	mW
			3.1	mW/°C
	Collector current	I <sub>C</sub>	50	mA
	Collector-Emitter voltage	V <sub>CEO</sub>	80	V
	Emitter-Collector voltage	V <sub>ECO</sub>	7	V
Total power dissipation		P <sub>TOT</sub>	200	mW
Isolation voltage <sup>*1</sup>		V <sub>ISO</sub>	3750	V rms
Operating temperature		T <sub>OPR</sub>	-55 ~ +110	°C
Storage temperature		T <sub>STG</sub>	-55 ~ +125	°C
Soldering temperature <sup>*2</sup>		T <sub>SOL</sub>	260	°C

Notes

\*1 AC for 1 minute, R.H.= 40 ~ 60% R.H. In this test, pins 1 & 2 are shorted together, and pins 3 & 4 are shorted together.

\*2 For 10 seconds.

### Electrical Characteristics ( $T_a=25^{\circ}\text{C}$ unless specified otherwise)

#### Input

Parameter	Symbol	Min.	Typ.*	Max.	Unit	Condition
Forward voltage	$V_F$	-	1.2	1.4	V	$I_F = 20\text{mA}$
Reverse current	$I_R$	-	-	10	$\mu\text{A}$	$V_R = 4\text{V}$
Input capacitance	$C_{in}$	-	30	250	pF	$V = 0, f = 1\text{kHz}$

#### Output

Parameter	Symbol	Min.	Typ.*	Max.	Unit	Condition
Collector-Emitter dark current	$I_{CEO}$	-	-	100	nA	$V_{CE} = 20\text{V}, I_F = 0\text{mA}$
Collector-Emitter breakdown voltage	$BV_{CEO}$	80	-	-	V	$I_C = 0.1\text{mA}$
Emitter-Collector breakdown voltage	$BV_{ECO}$	7	-	-	V	$I_E = 0.1\text{mA}$

### Transfer Characteristics ( $T_a=25^{\circ}\text{C}$ unless specified otherwise)

Parameter	Symbol	Min.	Typ.*	Max.	Unit	Condition
Current Transfer ratio	EL3H7	50	-	600	%	$I_F = 5\text{mA}, V_{CE} = 5\text{V}$
	EL3H7A	80	-	160		
	EL3H7B	130	-	260		
	EL3H7C	200	-	400		
	EL3H7D	300	-	600		
	EL3H7E	100	-	200		
	EL3H7F	150	-	300		$I_F = 10\text{mA}, V_{CE} = 5\text{V}$
	EL3H7H	40	-	80		
	EL3H7I	63	-	125		
	EL3H7J	100	-	200		
	EL3H7K	160	-	320		
		CTR				

### Transfer Characteristics ( $T_a=25^\circ\text{C}$ unless specified otherwise)

Parameter	Symbol	Min.	Typ.*	Max.	Unit	Condition
Collector-Emitter saturation voltage	$V_{CE(sat)}$	-	0.1	0.2	V	$I_F = 10\text{mA}$ , $I_C = 1\text{mA}$
Isolation resistance	$R_{IO}$	$5 \times 10^{10}$	-	-	$\Omega$	$V_{IO} = 500\text{Vdc}$ , 40~60% R.H.
Floating capacitance	$C_{IO}$	-	0.3	1.0	pF	$V_{IO} = 0$ , $f = 1\text{MHz}$
Rise time	$t_r$	-	5	18	$\mu\text{s}$	$V_{CE} = 2\text{V}$ , $I_C = 2\text{mA}$ , $R_L = 100\Omega$
Fall time	$t_f$	-	3	18	$\mu\text{s}$	

\* Typical values at  $T_a = 25^\circ\text{C}$

EVERLIGHT

### Typical Performance Curves

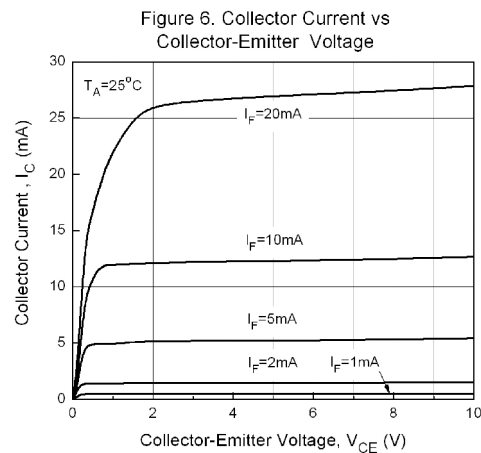
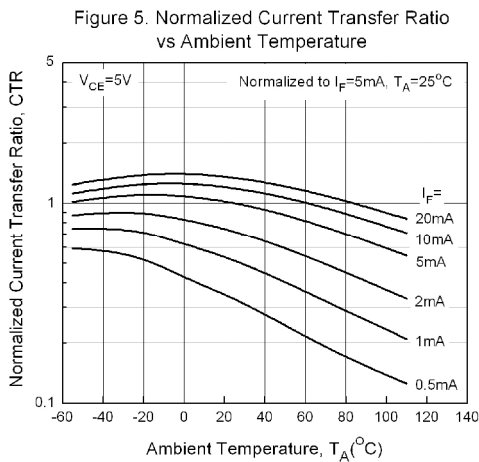
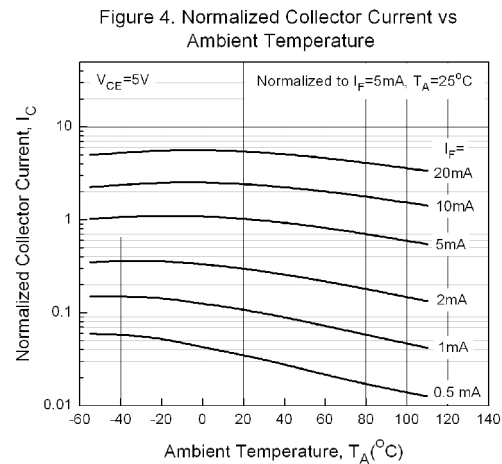
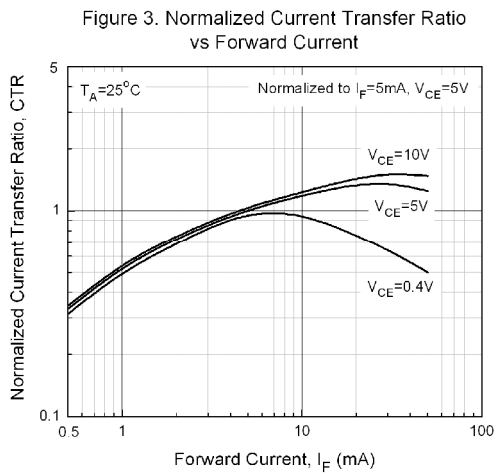
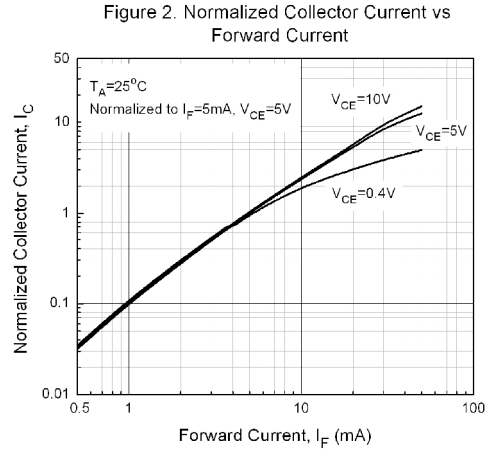
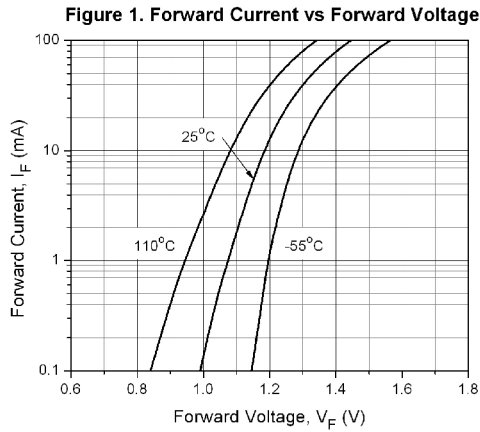

Figure 7. Collector Current vs Collector-Emitter Voltage

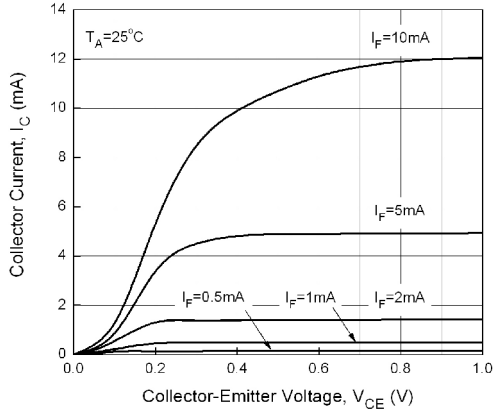

Figure 8. Collector Dark Current vs Ambient Temperature

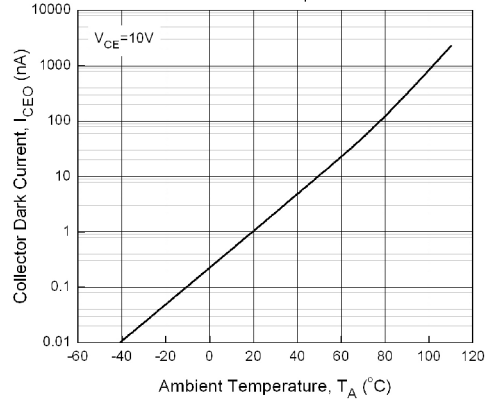

Figure 9. Collector-Emitter Saturation Voltage vs Ambient Temperature

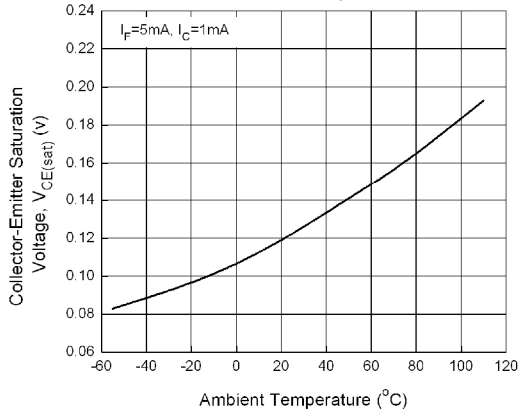

Figure 10. Switching Time vs Load Resistance

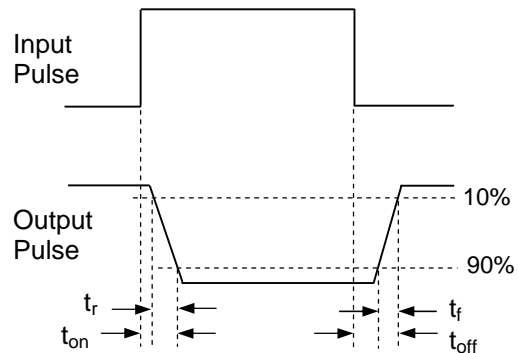
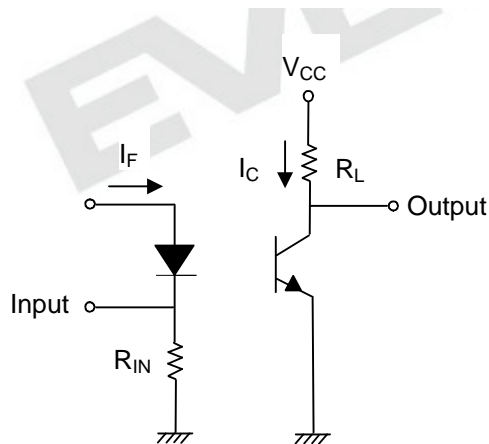
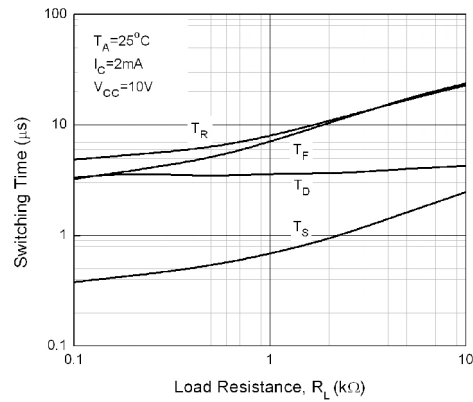

Figure 11. Switching Time Test Circuit & Waveforms

### Order Information

#### Part Number

# EL3H7(X)(Y)-VG

#### Note

3H7 = Part No.

X = CTR Rank (A, B, C, D, E, F, H, I, J, K or none)

Y = Tape and reel option (TA, TB, EA, EB or none).

V = VDE (optional)

G = Halogens free

Option	Description	Packing quantity
None	Standard SMD option	100 units per tube
-V	Standard SMD option + VDE	100 units per tube
(TA)	TA Tape & reel option	5000 units per reel
(TB)	TB Tape & reel option	5000 units per reel
(TA)-V	TA Tape & reel option + VDE	5000 units per reel
(TB)-V	TB Tape & reel option + VDE	5000 units per reel
(EA)	TA Tape & reel option	1000 units per reel
(EB)	TB Tape & reel option	1000 units per reel
(EA)-V	TA Tape & reel option + VDE	1000 units per reel
(EB)-V	TB Tape & reel option + VDE	1000 units per reel

### Package Drawing (Dimensions in mm)

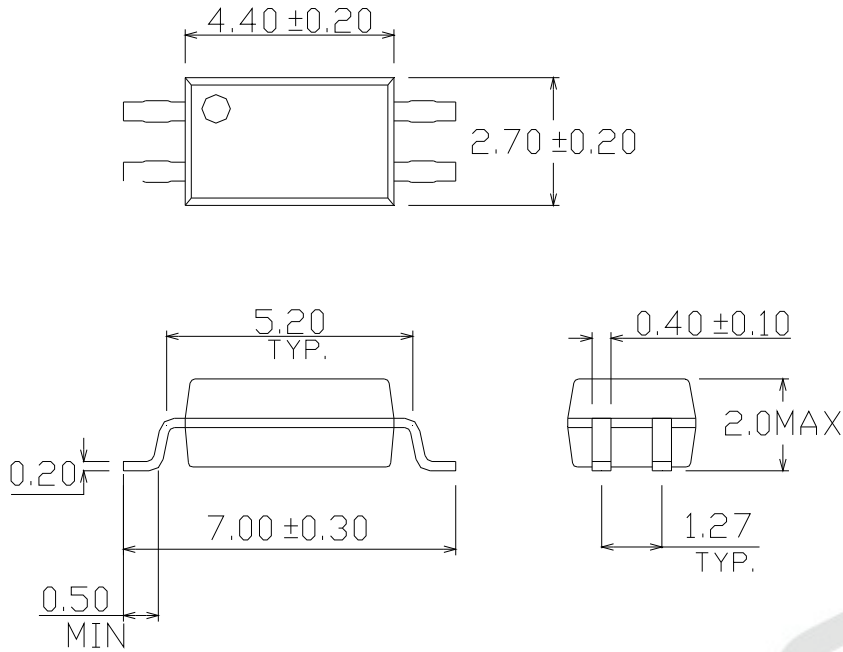

### Recommended pad layout for surface mount leadform

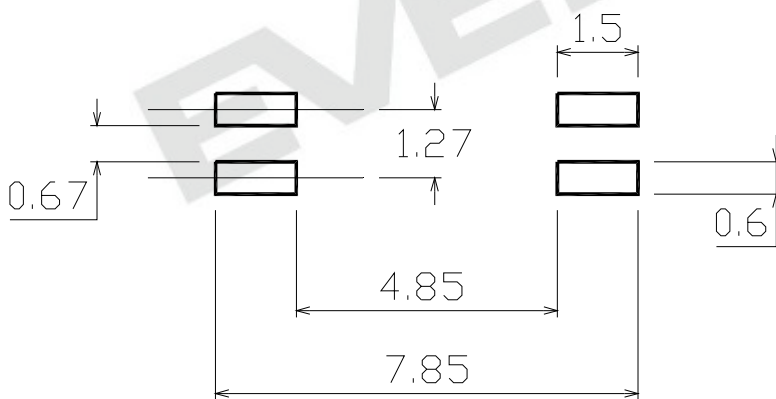



### Device Marking



### Notes

EL	denotes Everlight
3H7	denotes Device Number
R	denotes CTR Rank (A, B, C, D, E, F, H, I, J, K or none)
Y	denotes 1 digit Year code
WW	denotes 2 digit Week code
V	denotes VDE (optional)

EVERLIGHT

### Tape & Reel Packing Specifications

**Option TA**

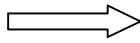
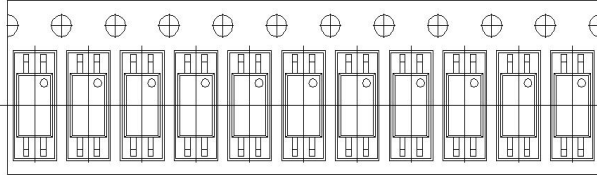

Direction of feed from reel

**Option TB**

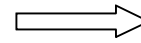
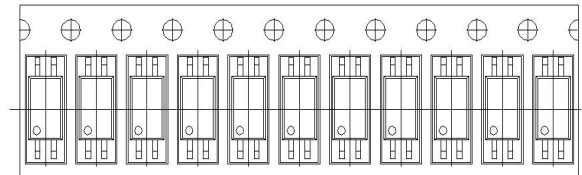

Direction of feed from reel

### Tape dimensions

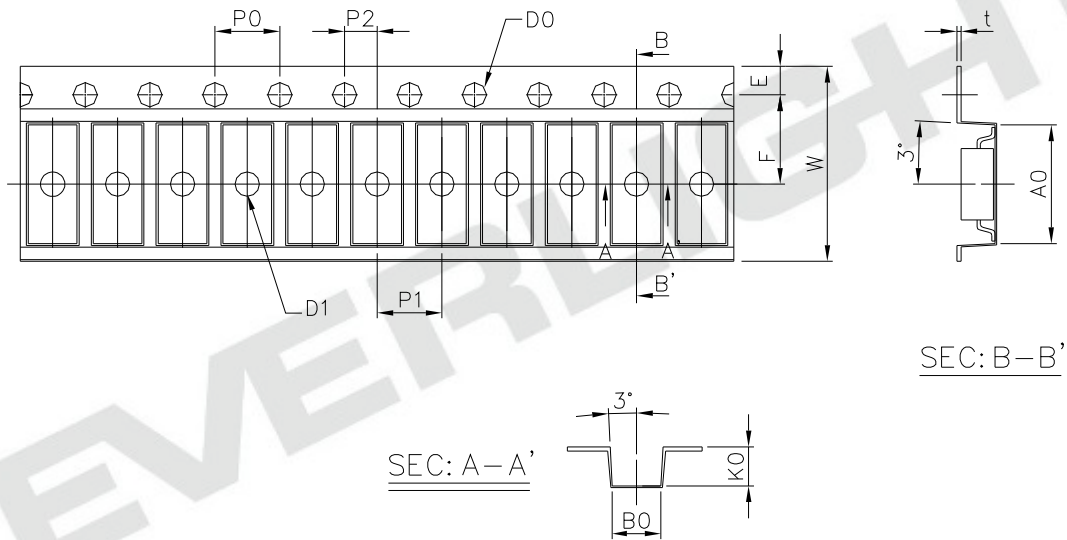

Dimension No.	<b>A</b>	<b>B</b>	<b>Do</b>	<b>D1</b>	<b>E</b>	<b>F</b>
Dimension (mm)	3.0 ± 0.1	7.3 ± 0.1	1.5 + 0.1/-0	1.5 ± 0.1	1.75 ± 0.1	5.5 ± 0.1
Dimension No.	<b>Po</b>	<b>P1</b>	<b>P2</b>	<b>t</b>	<b>W</b>	<b>K</b>
Dimension (mm)	4.0 ± 0.15	4.0 ± 0.1	2.0 ± 0.1	0.25 ± 0.03	12.0 ± 0.2	2.4 ± 0.1

### Solder Reflow Temperature Profile

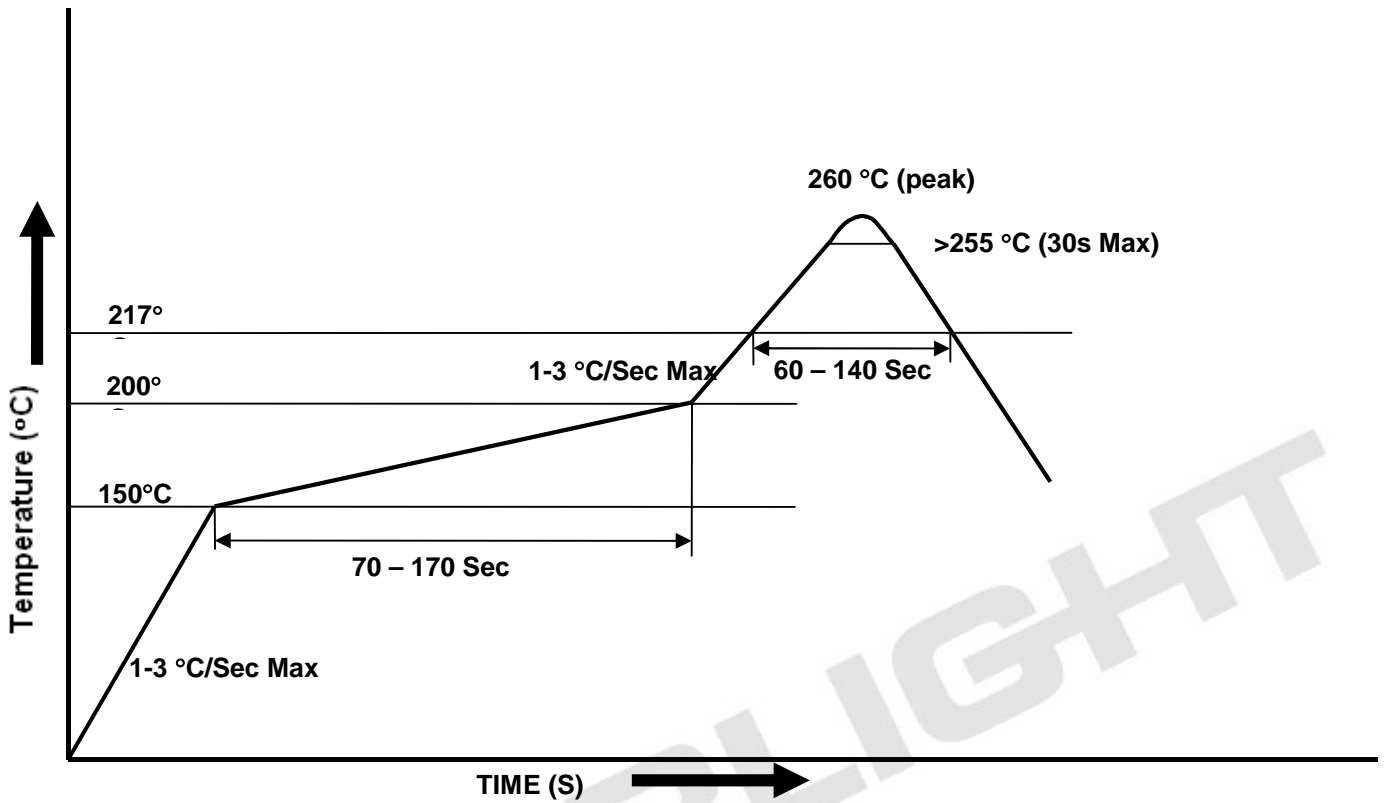

### DISCLAIMER

1. The specifications in this datasheet may be changed without notice. EVERLIGHT reserves the authority on material change for above specification.
2. When using this product, please observe the absolute maximum ratings and the instructions for use as outlined in this datasheet. EVERLIGHT assumes no responsibility for any damage resulting from use of the product which does not comply with the absolute maximum ratings and the instructions included in this datasheet.
3. These specification sheets include materials protected under copyright of EVERLIGHT. Reproduction in any form is prohibited without the specific consent of EVERLIGHT.

EVERLIGHT